



**EUROLOY**

# HADDE SARF MALZEMELERİ

*ROLLING MILL AUXILIARY MATERIALS*



 PCD & PcBN Nerbür Ucu / PCD & PcBN Notch Tool  
Yarım Yüzey / Half Face

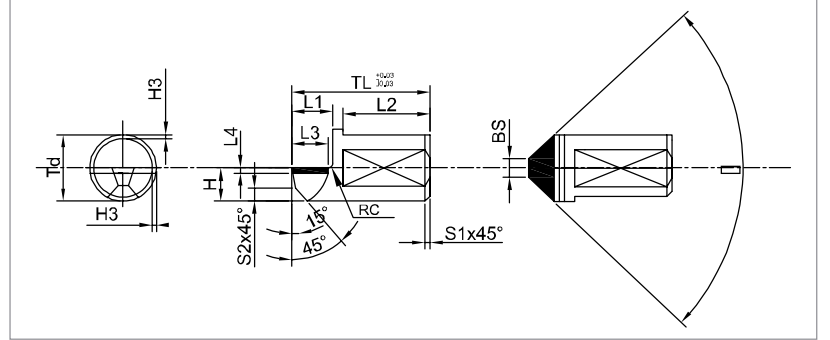

PCD	PcBN	Ebat Dimension	Td(mm)	TL(mm)	BS(mm)	L1	H
PCDHN625	CBNHN625	N6	2,5	5,0	0,8	1,6	1,8
PCDHN831	CBNHN830	N8	3	5,7	0,7	1,8	2
PCDHN104	CBNHN104	N10	4	7,0	0,9	2,1	2,2
PCDHN125	CBNHN125	N12	5	8,3	1,1	2,4	2,7
PCDHN145	CBNHN145	N14	5	10,0	1,2	2,6	2,7
PCDHN166	CBNHN166	N16	6	11,0	1,4	3,2	3,5
PCDHN186	CBNHN186	N18	6	14,0	1,6	3,2	3,5
PCDHN208	CBNHN208	N20	8	14,0	1,8	4,3	4,0
PCDHN228	CBNHN228	N22	8	15,0	2,0	4,3	4,0
PCDHN2410	CBNHN2410	N24	10	17,0	2,2	5	5,0
PCDHN2610	CBNHN2610	N26	10	19,0	2,4	5,3	5,0
PCDHN3012	CBNHN3012	N30	12	21,0	2,8	6,4	6,0
PCDHN3212	CBNHN3212	N32	12	22,1	3,0	6,4	6,0
PCDHN3614	CBNHN3614	N36	14	24,0	3,7	6,7	7,0
PCDHN4014	CBNHN4014	N40	14	29,0	4,0	6,7	7,0
Özel Sipariş Special Order							

Özel Sipariş kısmı müşteri tarafından doldurulur.  
The Special Order section is filled in by the customer.

 PCD & PcBN Nerbür Ucu / PCD & PcBN Notch Tool  
Tam Yüzey / Full Face

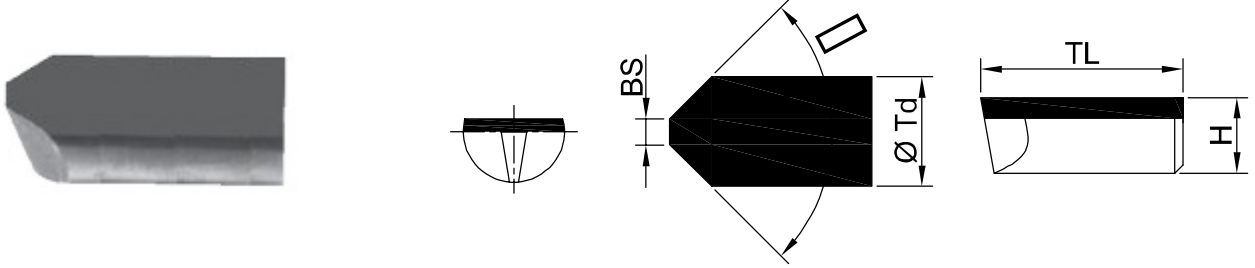

PCD	PcBN	Ebat Dimension	ØTd(mm)	TL(mm)	BS(mm)	H(mm)
PCDFN620	CBNFN625	N6	2	3,5	0,6	1,2
PCDFN625	CBNFN830	N6	2,5	4,0	0,7	1,3
PCDFN830	CBNFN104	N8	3	5,7	0,9	1,5
PCDFN104	CBNFN125	N10	4	7,0	1,0	2
PCDFN124	CBNFN145	N12	4	9,0	1,0	2
PCDFN145	CBNFN166	N14	5	10,0	1,4	2,5
PCDFN166	CBNFN186	N16	6	12,0	1,6	3
PCDFN186	CBNFN208	N18	6	13,0	1,8	3
PCDFN257	CBNFN228	N25	7	15,0	2,5	3,5
PCDFN329	CBNFN2410	N32	9	19,4	3,2	4,5
Özel Sipariş Special Order						

Özel Sipariş kısmı müşteri tarafından doldurulur.  
The Special Order section is filled in by the customer.

 K05 & K10 Karbür Nevür Ucu / Carbide Notch Tool  
Yarım Yüzey / Half Face

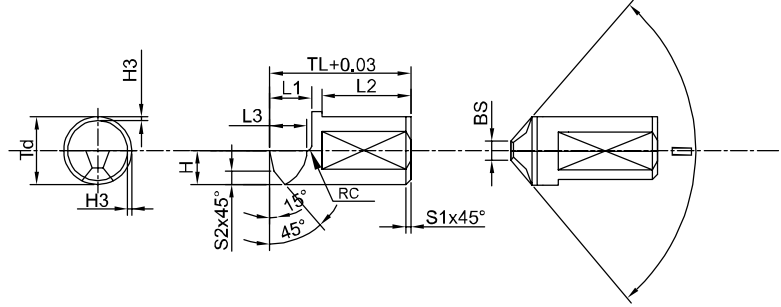
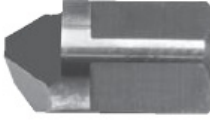

Kod Code	Ebat Dimension	ØTd(mm)	TL(mm)	BS(mm)	L1	H
CRN625	N6	2,5	5,0	0,8	1,6	1,8
CRN830	N8	3	5,7	0,7	1,8	2,0
CRN104	N10	4	7,0	0,9	2,1	2,2
CRN125	N12	5	8,3	1,1	2,4	2,7
CRN145	N14	5	10,0	1,2	2,6	2,7
CRN166	N16	6	11,0	1,4	3,2	3,5
CRN186	N18	6	14,0	1,6	3,2	3,5
CRN208	N20	8	14,0	1,8	4,3	4,0
CRN228	N22	8	15,0	2,0	4,3	4,0
CRN2410	N24	10	17,0	2,2	5,0	5,0
CRN2610	N26	10	19,0	2,4	5,3	5,0
CRN3012	N30	12	21,0	2,8	6,4	6,0
CRN3212	N32	12	22,1	3,0	6,4	6,0
CRN3614	N36	14	24,0	3,7	6,7	7,0
CRN4014	N40	14	29,0	4,0	6,7	7,0
CRN5016	N50	16	36,0	5,0	7,5	8,0
Özel Sipariş Special Order						

Özel Sipariş kısmı müşteri tarafından doldurulur.  
The Special Order section is filled in by the customer.

**K05 & K10 Karbür ve PcBN Nevür Ucu Bambo Tip**  
**Carbide and PcBN Notch Tool Bamboo Type**

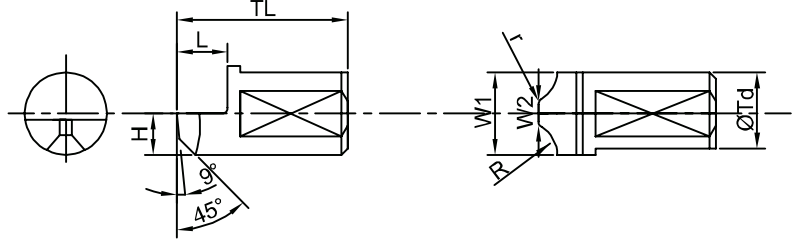

Karbür Carbide	PcBN	R	W1	W2	r	ØTd	TL	L	H
PCDBHN20	CBNBHN20	5,8	9	1,28	0,2	9	15	3,5	4,5
PCDBHN22	CBNBHN22	7,1	10,6	1,48	0,3	11	18,5	4	5,5
PCDBHN25	CBNBHN25	8,3	11	1,78	0,5	11	20	4	5,5
PCDBHN28	CBNBHN28	6,2	11	1,7	0,5	11	23	5	5,5
PCDBHN30	CBNBHN30	6,6	11,4	1,78	0,5	12	24	5	6
PCDBHN32	CBNBHN32	9,5	13	2,2	0,5	13	26	5	6,5
PCDBHN40	CBNBHN40	10,7	15	2,6	0,5	15	31	5	7,5
Özel Sipariş Special Order									

Özel Sipariş kısmı müşteri tarafından doldurulur.  
The Special Order section is filled in by the customer.

**Karbür Markalama Kalemı**  
**Carbide Marking Tool**

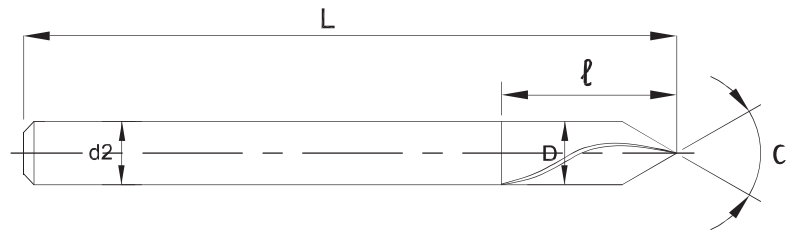

Uç Çapı Dimension	Boy Length	Kesici Helis Boyu Flute Length	Uç Kalınlığı Web Thickness T= 0,1D	Şaft Çapı Shaft Dia	Uç Açısı Tip Angle
D	L	l		d2	a
Ø6 (mm)	60 mm	12 mm		Ø6 (mm)	60°
Özel Sipariş Special Order					

Özel Sipariş kısmı müşteri tarafından doldurulur.  
The Special Order section is filled in by the customer.

## HADDE SARF MALZEMELERİ

### ROLLING MILL AUCILIARY MATERIAL

 PCD Markalama Kalemı  
PCD Marking Tool

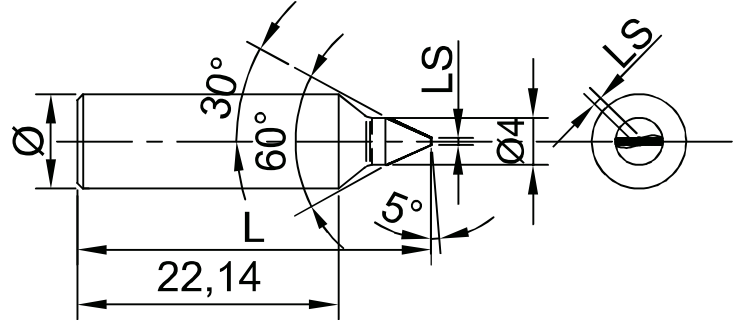
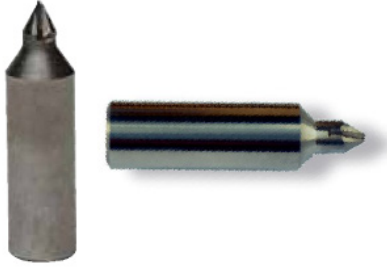

Ölçü Spec	Ø(mm)	L	LS
N8	8	30	0,6
N10	8	30	0,8
N14-N16	8	30	1
N20-N25	8	30	1,2
N32	8	30	1,5

 ED Markalama Kalemı  
ED Marking Tool



Uç Çapı Dimension	Boy Length	Şaft Çapı Shaft Dia
Ø1mm	30-60mm	Ø3mm
Ø1,2mm	30-60mm	Ø3mm
Ø1,4mm	30-60mm	Ø3mm
Ø1,8mm	30-60mm	Ø3mm
Ø2,0mm	30-60mm	Ø3mm

## HADDE SARF MALZEMELERİ

### ROLLING MILL AUCILIARY MATERIAL

 PCBN Kalibre Açma Uç / RCGX  
PCBN Calibre Insert / RCGX

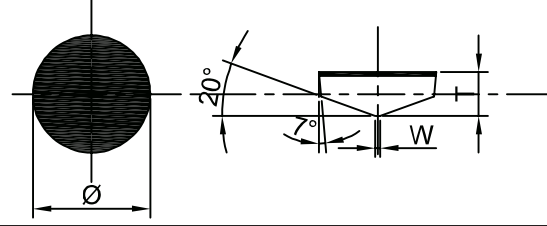

Kod Code	Ø(mm)±0,05	T(mm)±0,13	W(mm)±0,1
RCGX060300	6,35	3,18	0,73
RCGX075300	7,5	3,18	0,75
RCGX090300	9,525	3,18	0,75
RCGX110400	11,4	4,76	1
RCGX120400	12,7	4,76	1
RCGX151000	15,875	10	2
RCGX190600	19,05	6,35	4
Özel Sipariş Special Order			

 PCBN Kalibre Açma Kateri  
PCBN Calibre Tool

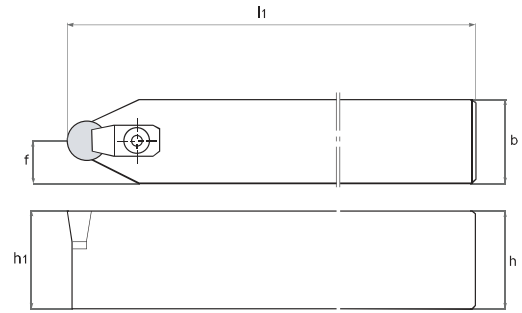

Kod Code	Boyutlar / Size (mm)		
	h(=h1)	b	l1
CRCDN3225T	32	25	170
Özel Sipariş Special Order			

 Sfero Merdane Kalibre Açma Kateri ve Karbür Ucu  
Carbide Insert's and Tools for Sfero Roll Calibre

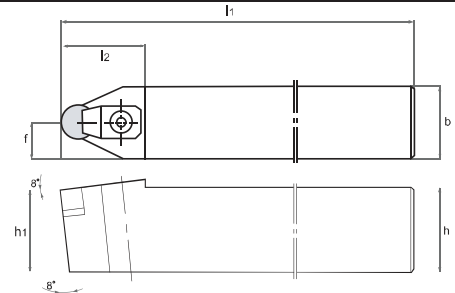

CRDNN	Takım Boyutları Tool Dimensions			Karbür Uç Boyutları Carbide Insert Dimensions		
	Genişlik Width(mm)	Yükseklik Height(mm)	Uzunluk Length(mm)	Çap Diameter(mm)	Yükseklik Height(mm)	Pah Derecesi Chamfer
Özel Sipariş Special Order						

Özel Sipariş kısmı müşteri tarafından doldurulur.  
The Special Order section is filled in by the customer.

# HADDE SARF MALZEMELERİ

## ROLLING MILL AUCILIARY MATERIAL

**Merdane Tornalama / Roll Turning**  
**Seramik Uç / Ceramic Insert RCGX**

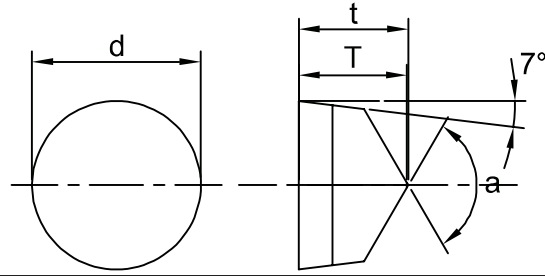

Kod Code	Boyutlar Size(mm)				Kesme Kalitesi Cutting Grade							
	d	t	T	a	ST100	ST300	ST500	ST700	SN26	SN300	SN400	SW800
RCGX060400	6,35	4,8	4,57	120°	*	*	*	*	*			*
RCGX060600	6,35	6,4	6,2	120°	*	*	*	*	*			*
RCGX060700	6,35	7,9	7,7	120°	*	*	*	*	*			*
RCGX090700	9,52	7,9	7,7	120°	*	*	*	*	*			*
RCGX120700	12,7	7,9	7,7	120°	*	*	*	*	*			*
RCGX151000	15,9	10	9,77	120°	*	*	*	*	*			*
RCGX191000	19,1	10	9,77	120°	*	*	*	*	*			*
RCGX251200	25,4	12	11,9	140°	*	*	*	*	*			*
Özel Sipariş Special Order												

**Kater**  
**Tool Holder-CRDCN**

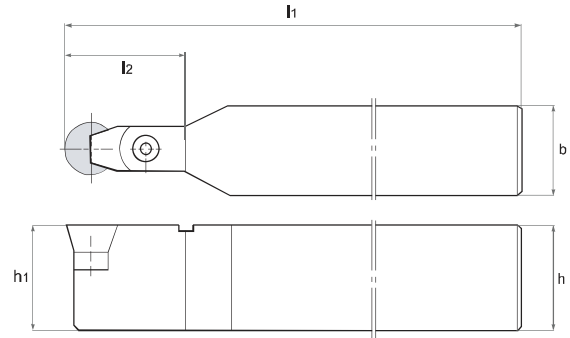

Kod Code	Boyutlar Size(mm)				Kesici Uç Insert	Yedek Parçalar Spare Parts			
	h(=h1)	b	l1	l2		Baskı Pabucu Clamps	Vida Screw	Altlık Shim	Anahtar Qwrench
CRDCN 3225P06-A4	32	25	170	20	RCGX 0604...	CLRC6	FM210	SHRC102	SHRC102
CRDCN 3225P06-A6	32	25	170	20	RCGX 0606...	CLRC6	FM210	SHRC102	SHRC102
CRDCN 3225P06-A7	32	25	170	20	RCGX 0607...	CLRC6	FM210	SHRC102	SHRC102
CRDCN 3225P09-A7	32	25	170	20	RCGX 0907...	CLRC9	FM310	SHRC103	SHRC103
CRDCN 3225P12-A7	32	25	170	20	RCGX 1207...	CLRC9	FM310	SHRC104	SHRC104
CRDCN 5040T12-A7	50	40	300	30	RCGX 1207...	CLRC9	FM310	SHRC104	SHRC104
CRDCN 5040T15-A1	50	40	300	35	RCGX 1510...	CLRC15	FM410	SHRC105	SHRC105
CRDCN 5040T19-A1	50	40	300	45	RCGX 1910...	CLRC15	FM410	SHRC106	SHRC106
CRDCN 5040T25-A1	50	40	300	50	RCGX 2512...	CLRC25	FM610	SHRC108	SHRC108
Özel Sipariş Special Order									

Özel Sipariş kısmı müşteri tarafından doldurulur.  
The Special Order section is filled in by the customer.



# HADDE SARF MALZEMELERİ

## ROLLING MILL AUCILIARY MATERIAL

 Merdane Tornalama / Roll Turning  
Seramik Uç / Ceramic Insert RCGX

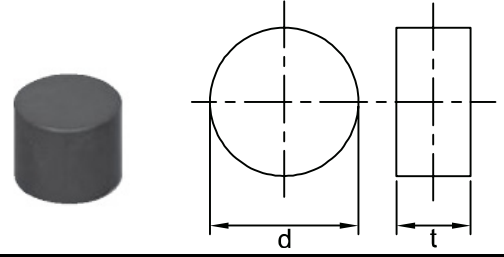

Kod Code	Boyutlar Size(mm)		Kesme Kalitesi Cutting Grade								
	d	t	ST100	ST300	SD200	SZ200	SN26	SN300	SN400	SN500	SW800
RNGN 060200	6,35	2,38				!	*				*
RNGN 060300	6,35	3,18				!					
RNGN 060400	6,35	4,76	*			!	*	*			*
RNGN 090300	9,52	3,18	*			!	*			*	*
RNGN 090400	9,52	4,76	*	*	*	!	*			*	*
RNGN 120300	12,7	3,18				!	*	*	*	*	*
RNGN 120400	12,7	4,76	*	*	*	*!					
RNGN 120600	12,7	6,35				!	*	*	*	*	*
RNGN 120700	12,7	7,94	*	*		*!	*	*			*
RNGN 150700	15,87	7,94	*	*		!	*			*	*
RNGN 190600	19,05	6,35	*	*		!		*		*	
RNGN 190700	19,05	7,94	*			*!		*			*
RNGN 250700	25,4	7,94	*			*	*				
RNGN 250900	25,4	9,52									
RNGN 320900	31,75	9,52	*								
RNGN 0807MO	8	7,94	*								
RNGN 1007MO	10	7,94	*								
RNGN 1207MO	12	7,94	*								
Özel Sipariş Special Order											

 Kater  
Tool Holder-CRDCN

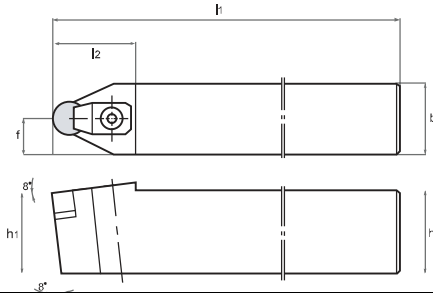

Kod Code	Boyutlar Size(mm)					Kesici Uç Insert	Yedek Parçalar Spare Parts			
	h(=h1)	b	l1	l2	l2		Baskı Pabucu Clamps	Vida Screw	Altlık Shim	Anahtar Wrench
CRDCN 3225P06-A4	25	25	150	32	13	RNGN 0904	SM3	TM408	SHRN3A	LW4
CRDCN 3225P06-A6	25	25	150	32	13	RNGN 0907	SM3	TM408	SRHN3A	LW4
CRDCN 3225P06-A7	25	25	150	32	13	RNGN 1204	UH1	TM510	SRHN4A	LW4
CRDCN 3225P09-A7	25	25	150	32	13	RNGN 1207	UH1	TM510	SRHN4A	LW4
CRDCN 3225P12-A7	32	25	170	32	13	RNGN 1204	UH1	TM510	SRHN4A	LW4
CRDCN 5040T12-A7	32	25	170	32	13	RNGN 1207	UH1	TM510	SRHN4A	LW4
CRDCN 5040T15-A1	32	25	170	32	13	RNGN 1507	UH1	TM510	SRHN5A	LW4
CRDCN 5040T19-A1	32	25	170	32	13	RNGN 1907	UH4	FM19X	SHRN6	LW4
Özel Sipariş Special Order										

Özel Sipariş kısmı müşteri tarafından doldurulur.  
The Special Order section is filled in by the customer.

## HADDE SARF MALZEMELERİ

### ROLLING MILL AUCILIARY MATERIAL

 Kanal Açma / Grooving  
Seramik Uç / Ceramic Insert SGR

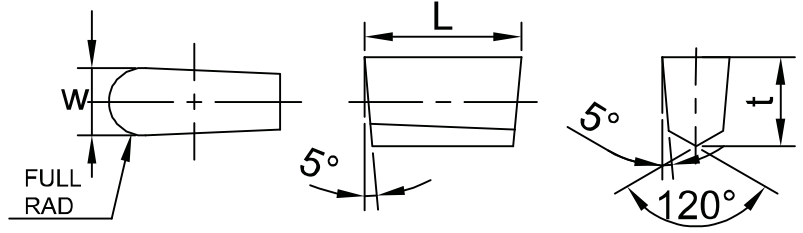

Kod Code	Boyutlar Size(mm)			Kesme Kalitesi Cutting Grade								
	L	W	T	ST100	ST300	SD200	SZ200	SN26	SN300	SN400	SN500	SW800
SGR4012	12	4	5	*	*		*			*		
SGR5012	12	5	5	*	*		*			*		
SGR6015	15	6	7,5	*	*		*					
SGR7015	15	7	7,5	*	*		*					
SGR8015	15	8	7,5	*	*		*					
SGR1015	15	10	7,5	*	*		*					
Özel Sipariş Special Order												

 Seramik Uç  
Ceramic Insert SGF

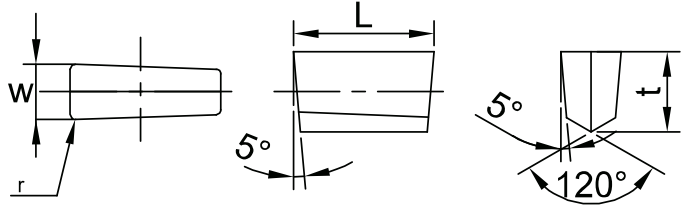

Kod Code	Boyutlar Size(mm)			Kesme Kalitesi Cutting Grade								
	L	W	T	ST100	ST300	SD200	SZ200	SN26	SN300	SN400	SN500	SW800
SGF4012	12	4	0,5	*	*		*			*		
SGF5012	12	5	0,8	*	*		*			*		
SGF6015	15	6	0,8	*	*		*					
SGF7015	15	7	0,8	*	*		*					
SGF8015	15	8	0,8	*	*		*					
SGF1015	15	10	0,8	*	*		*					
Özel Sipariş Special Order												

Özel Sipariş kısmı müşteri tarafından doldurulur.  
The Special Order section is filled in by the customer.

## HADDE SARF MALZEMELERİ

### ROLLING MILL AUCILIARY MATERIAL

 Kanal Açma / Grooving  
Kater / Tool Holder CSGR

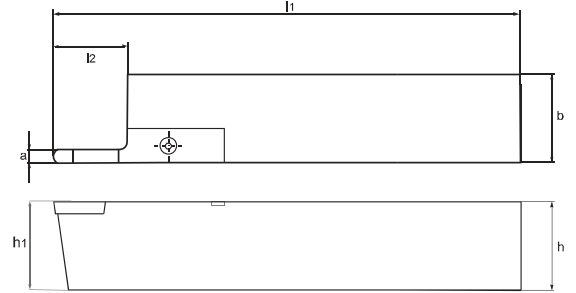

Kod Code	Boyutlar Size(mm)					Kesici Uç Insert	Vida Screw	Anahtar Wrench
	a	h(=h1)	b	l2	l2			
CSGR 3225P4012R/L	4	32	25	170	19	SGR 4012	SGL4/BM518	LW3
CSGR 3225P4012R/L	5	32	25	170	19	SGR 5012	SGL4/BM518	LW4
CSGR 3225P4012R/L	6	32	25	170	19	SGR 6015	SGL4/BM518	LW4
CSGR 3225P4012R/L	7	32	25	170	19	SGR 7015	SGL4/BM518	LW5
CSGR 3225P4012R/L	8	32	25	170	19	SGR 8015	SG7/BM618	LW5
CSGR 3225P4012R/L	10	32	25	170	19	SGR 1015	SG8/BM618	LW5
Özel Sipariş Special Order								

 Kanal Açma için Seramik Uç ve Kater (N Tipi)  
Ceramic Insert and Tool Holder for Grooving

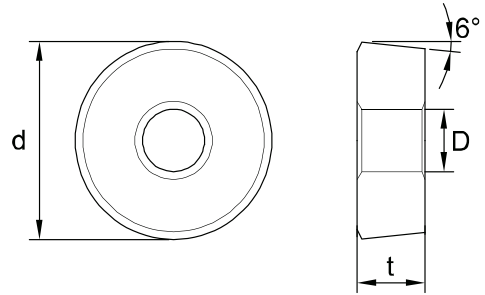

HRCD Boyutlar Size(mm)				Kesici Uç Insert
H	W	L1	L2	
				CDH-22
				CDH-23
60-80	60-80	450-750	120-250	CDH-53
Özel Sipariş Special Order				

Özel Sipariş kısmı müşteri tarafından doldurulur.  
The Special Order section is filled in by the customer.

# HADDE SARF MALZEMELERİ

## ROLLING MILL AUCILIARY MATERIAL

### Nervür Tutucu / Notch Holder Konik Şaftlı / Cone Shaped Shaft

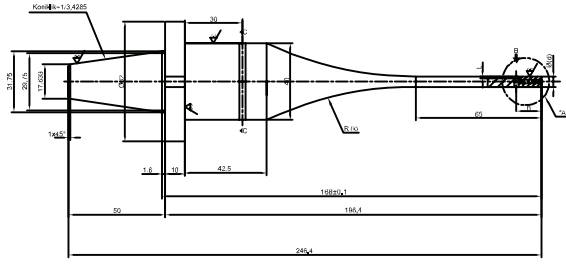

A-DETAYI (D8-D14)

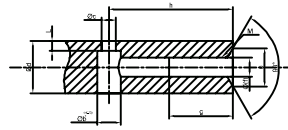

B-BAKIŞI

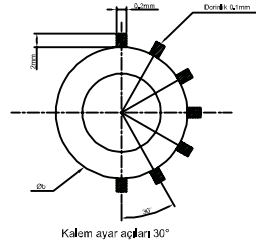

C-C KESİTİ

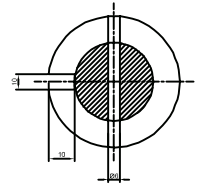

Kalem ayar açıları 30°

Kod Code	b	d	k	c	c	L	M	f	g	h
SD-8/A	Ø 2,5	Ø 5,5	205	5	Ø 1,5	1	M3	2	10	13
SD-8/B	Ø 3	Ø 5,5	205	5	Ø 1,5	1	M3	2	10	13
SD-10	Ø 3	Ø 6,8	205	6	Ø 1,5	1,4	M3	2,5	10	13
SD-12	Ø 4	Ø 8,5	205	7,5	Ø 2	1,25	M3	3	9	13
SD-14	Ø 5	Ø 9,8	205	7,5	Ø 3	1,5	M3	4,5	9	13
SD-16	Ø 5	Ø 11,4	205	10,5	Ø 4	1,5	M3	4,5	19	30
SD-18	Ø 6	Ø 12,9	205	10,5	Ø 5	1,95	M3	5	19	30
SD-20	Ø 6	Ø 14,4	205	10,5	Ø 5	2,7	M3	5	19	30
Özel Sipariş Special Order										

### Silindirik Şaftlı Nervür Tutucu Cylindrical Shaped Shaft

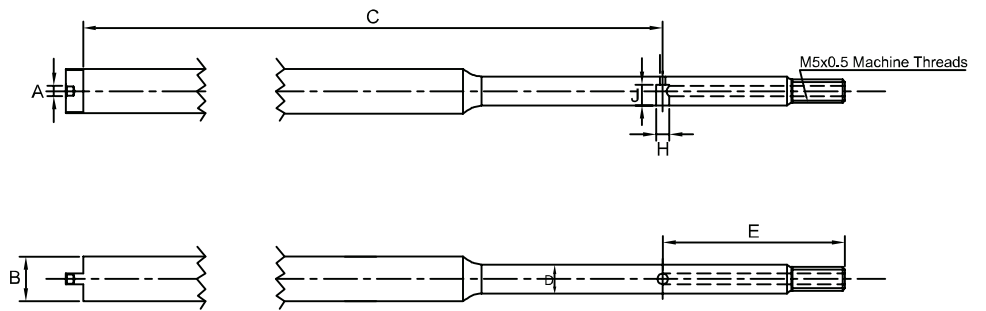

Kod Code	A	B	C	D	E	H	J	N
SD-8/A	3	8,5	170	6	35	2	3	M4x0,35
SD-8/B	3	8,5	170	5,5	35	2,5	4	M5x0,5
SD-10	3	8,5	170	7	35	3	5	M7x0,75
SD-12	3	8,5	170	8,5	35	4	5,5	M8x0,75
Özel Sipariş Special Order								

Özel Sipariş kısmı müşteri tarafından doldurulur.  
The Special Order section is filled in by the customer.



MERDANE TAŞLAMA TAŞLARI  
GRINDING WHEELS



# TAŞLAMA DİSKLERİ TİPLERİ

## GRINDING WHEELS

TİP	SAYFA	TİP	SAYFA	TİP	SAYFA
1A1	16	4A2	23	11V9	29
1A8	17	4B2	23	11Y9	29
1A1R	17	4M1	24	12A2	30
1E1	18	6A2	24	12V4	31
1EE1	18	6A2C	25	12V9	31
1E6Q	19	6A9	25	14A1	32
1V1	19	6F2	26	14EE1	32
1FF1	20	6F5	26	14U1	33
1FF6Y	21	9A3	27	DW	33
2A2T	21	11A2	27	HH1	34
2FF2	22	11B2	28	HMF	34
3A1	22	11C9	28	P	34

# MONO BLOK KARBÜR RING KALİBRE VE OVAL AÇMA TAŞLARI

## MONOBLOK CARBIDE RING GROOVING AND OVAL WHEEL

**RD (Rezin Bağlı) MD (Metal Bağlı) 1FF1 Kalibre**  
**RD (Resin Bonded) MD (Metal Bonded) 1FF1 Calibre**

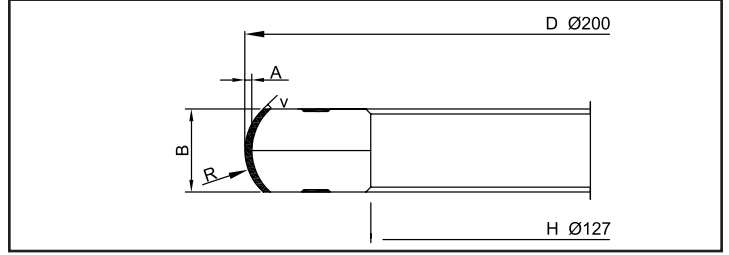
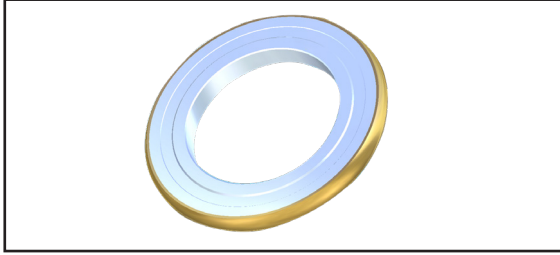

Kod / Code	2(RD)	A	B	V
R7014	12,14	5,27	12,29	19
R7015	12,85	5,52	12,81	18,6
R7016	13,16	5,68	13,29	20,3
R7017	13,66	5,83	13,8	19,8
R7018	14,17	6,08	14,31	19,2
R7019	15,18	6,59	15,33	18,4
R7020	16,19	7,09	16,35	17,6
Özel Sipariş Special Order				

**RD (Rezin Bağlı) MD (Metal Bağlı) 14FF1 Oval & ED (Elektro Plate Kaplama)**  
**RD (Resin Bonded) MD (Metal Bonded) 14FF1 Oval & (ED Electroplating)**

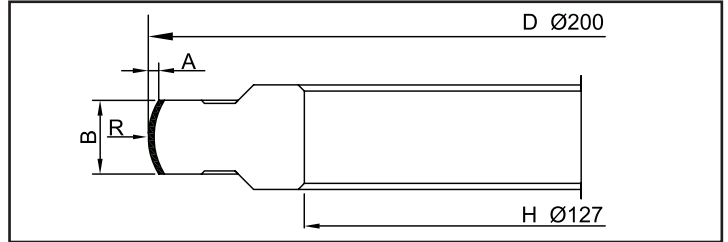
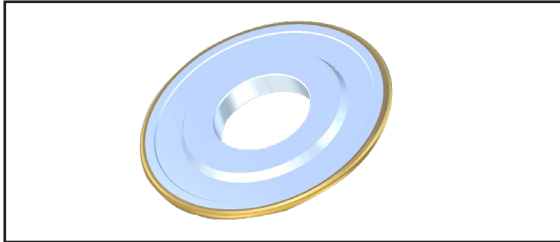

Kod / Code	A	B	2(RD)
R7014	1,28	9,53	19
R7015	1,6	10,24	18
R7016	1,9	13,53	26
R7017	2,55	16,73	30
R7018	3,15	19,72	34
Özel Sipariş Special Order			

### 1A1 Dış Çap Taşlama Diski / 1A1 Outer Diameter Grinding Wheel

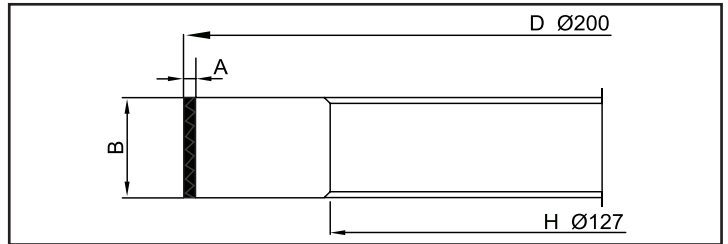
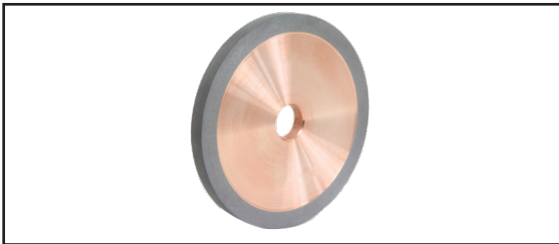

Kod / Code	A	B	H
A7020	5	20	127
Özel Sipariş Special Order			

Özel Sipariş kısmı müşteri tarafından doldurulur.  
 The Special Order section is filled in by the customer.



# YASSI HADDE MERDANESİ TAŞLAMA TAŞLARI

## ROLL GRINDING WHEELS



Merdane taşlama işlemi, çeşitli türde merdaneye uygulanan silindirik taşlama ve hassas taşlama işlemlerinin özel bir şeklidir. Merdane taşlama taşları, çelik, pirinç, bakır, alüminyum, kağıt ve tekstil endüstrilerinde kullanılan merdanelerin üretimi esnasında ve tekrar taşlanmasında kullanılır.

*Roll Grinding is a specialized form of cylindrical and precision grinding of various kind of rolls. Roll grinding wheels are used in the re-grinding and production grinding of rolls for steel, brass, copper, aluminium, printing paper and textile industries.*

Merdane Roll	Merdane Hammaddesi Raw Material of Roll	Sertlik Hardness	Kullanım Usage	Kodlama Specification
Sıcak Hadde Merdanesi Hot Mill Work Roll	Çil Dökme Demir Chiled Iron Granite Granite Sünek Dökme Demir (FCD) Cast Iron (FCD)	Hs 60 82	Kaba / Rough Finiş / Finish	GC36K7B GC80J7B
	Dökme Çelik / Cast Steel Adamit Çelik / Adamite Steel	Hs 35 40	Kaba / Rough Finiş / Finish	WA30L6B WA60J7B
Sıcak Hadde Destek M. Hot Mill Back - up Roll	Dökme Çelik Cast Steel	Hs 40 50	Kaba / Rough Finiş / Finish	WA30K7B WA60J7B
Soğuk Hadde M. Cold Mill Work Roll	Sertleştirilmiş Çelik Hardened Steel	Hs 90 100	Kaba / Rough Yarı Finiş / Semi Finish Finiş / Finish Finiş / Finish	WA30K7B WA60J7B
Soğuk Hadde Destek M. Cold Mill Back Roll	Sertleştirilmiş Çelik / Hard Steel Dökme Çelik / Cast Steel	Hs 55 70	Kaba / Rough Finiş / Finish	WA36J7B WA60J78 WA120J7B WA240I7B
Sendzimir Hadde M. Sendzimir Mill Roll	Alaşımli Takım Çeliği Alloy Tool Steel	Hrc 60 64	Kaba / Rough Finiş / Finish Finiş / Finish Super Finiş / Super Finish	WA30J7B WA80J7B
Alüminyum Folyo M. Aluminium Fail Roll	Yüksek Sertlikli Çelik High Hardness Steel	Hs 90 100	Kaba / Rough Finiş / Finish Super Finiş / Super Finish	GC46H7B GC120H8B GC220F8B GC600F8B
Kağıt Haddeme M. Paper Mill Roll	Çil Dökme Demir Chilled Iron	Hs 60 80	Kaba / Rough Finiş / Finish	WA60J7B WA240I7B GC320G8B
	Granit, Pirinç, Lastik Granite, Brass, Rubber		Kaba / Rough Finiş / Finish	GC36J7B GC30H10B
Paslanmaz Çelik M. Stainless Steel Roll	Yumuşak Paslanmaz Çelik Soft Stainless Steel	300 Serisi	Kaba / Rough Finiş / Finish	GC46J8B
	Sert Paslanmaz Çelik Hard Stainless Steel	400 Serisi	Kaba / Rough Finiş / Finish	WA46J7B



Genel Taş Ölçüleri (DXTXH) Common Wheel Sizes	
Inch	mm
30X2XH	760x50xH
30X3XH	760x76xH
36X4XH	915x100xH
36X5XH	915x125xH
36X6XH	760x50xH
42X4XH	1065x100xH
42X5XH	1065x125xH

### Teknik Tavsiyeler / Technical Advice

Taşın kalitesi tezgahın motor gücüne ve merdanenin malzemesine bağlıdır. Genelde ikili taş, tekli taşa göre daha yumuşak kalite gerektirir. Yumuşak kalitede taş ise sert malzemeye uygundur.

*The grade of the wheel depends on the horsepower of the machine and the material being ground. In general, dual wheel grinders require softer grades than single wheel rinders. A soft grade wheel requires hard materials than soft materials.*



[www.euroloy.com](http://www.euroloy.com)

Head Office - La sede centrale  
Via Leonardo Da Vinci 4  
20054 Segrate  
Milano / Italia

✉ [info@euroloy.com](mailto:info@euroloy.com)

📷 [@euroloytools](https://www.instagram.com/euroloytools)

