

2023/07-1



**EURLOY**

**DELİK İŞLEME**

**DRILLING PRODUCT CATALOGUE**



# DEĞİŞTİRİLEBİLİR KARBÜR UÇ VE TAKIMLAR

## INDEXABLE DRILLS INSERTS

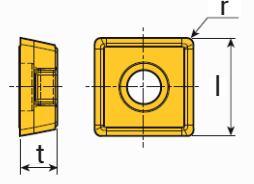

Ürün Görseli Product Image	CB	Uç Kodu Insert Code	C						Ölçüler Dimensions(mm)				
			TC1620	TC1630	TP2620	TP2630	TP3630	TP4630	TP5620	l	d	t	r
	DG	SPMG 050204				○		●	●	5	5	2,38	2,2
		SPMG 060204				●		●	○	6	6	2,38	2,6
		SPMG 07T308				●		●	●	7,94	7,94	3,97	2,8
		SPMG 090408				●		●	○	9,8	9,8	4,76	4,2
		SPMG 110408				●		●	○	11,5	11,5	4,76	4,4
		SPMG 140512				●		●	○	14,3	14,3	5,2	5,75

● Stok Ürün | Stock Item

○ Stok Dışı Ürün | Non Stock Item

□ Özel Ürün | Special Order

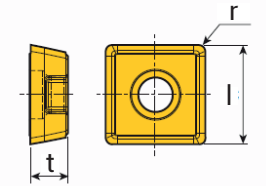

Ürün Görseli Product Image	CB	Uç Kodu Insert Code	H	Ölçüler Dimensions(mm)			
				l	d	t	r
	AL	SPGT 050204	●	5	5	2,38	2,2
		SPGT 060204	○	6	6	2,38	2,6
		SPGT 07T308	○	7,94	7,94	3,97	2,8
		SPGT 090408	○	9,8	9,8	4,76	4,2
		SPGT 110408	○	11,5	11,5	4,76	4,4
		SPGT 140512	○	14,3	14,3	5,2	5,75

● Stok Ürün | Stock Item

○ Stok Dışı Ürün | Non Stock Item

□ Özel Ürün | Special Order

# DEĞİŞTİRİLEBİLİR KARBÜR UÇ VE TAKIMLAR

## INDEXABLE DRILLS INSERTS

**SPGT Takımlar / D2T**  
SPGT Tools D2T

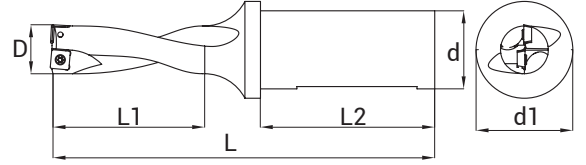

(mm)

Takım Kodu Order Code	D	d	d1	L	L1	L2	Vida Screw	Anahtar Torx Key
D2T-1320-SP05	13	20	25	94	26	50	SM2x5	T06
D2T-1420-SP05	14	20	25	97	28	50		
D2T-1520-SP05	15	20	25	100	30	50		
D2T-1625-SP06	16	25	34	110	32	50	SM2,2x5	
D2T-1725-SP06	17	25	34	112	34	56		
D2T-1825-SP06	18	25	34	114	36	56		
D2T-1925-SP06	19	25	34	116	38	56		
D2T-19525-SP06	19,5	25	34	119	40	56		
D2T-2025-SP06	20	25	34	119	40	56		
D2T-20525-SP06	20,5	25	34	122	42	56		
D2T-2125-SP06	21	25	34	122	42	56	SM2,5x7	T08
D2T-2225-SP07	22	25	34	125	44	56		
D2T-2325-SP07	23	25	34	128	46	56		
D2T-2425-SP07	24	25	34	129	48	56		
D2T-2525-SP07	25	25	34	131	50	56		
D2T-2625-SP07	26	25	34	134	52	56		
D2T-2725-SP07	27	25	34	137	54	56		
D2T-27525-SP09	27,5	25	34	140	56	56	SM3,5x8	T15
D2T-2825-SP09	28	25	34	140	56	56		
D2T-2925-SP09	29	25	34	143	58	56		
D2T-3032-SP09	30	32	44	150	60	60		
D2T-3132-SP09	31	32	44	153	62	60		
D2T-3232-SP09	32	32	44	156	64	60		
D2T-3332-SP09	33	32	44	159	66	60		
D2T-3432-SP11	34	32	44	162	68	60	SM4x11	
D2T-3532-SP11	35	32	44	165	70	60		
D2T-3632-SP11	36	32	44	168	72	60		
D2T-3732-SP11	37	32	44	171	74	60	SM4X11	T15
D2T-3832-SP11	38	32	44	174	76	60		
D2T-3932-SP11	39	32	44	177	78	60		
D2T-4032-SP11	40	32	44	180	80	60	SM5X11	R20
D2T-4132-SP11	41	32	44	183	82	60		

# DEĞİŞTİRİLEBİLİR KARBÜR UÇ VE TAKIMLAR

## INDEXABLE DRILLS INSERTS

**SPGT Takımlar / D3T**  
**SPGT Tools D3T**

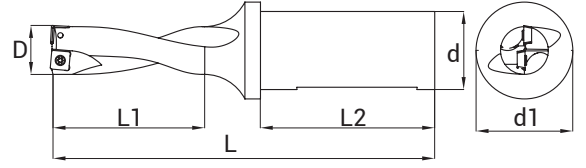

(mm)

Takım Kodu Order Code	D	d	d1	L	L1	L2	Vida Screw	Anahtar Torx Key
D3T-1320-SP05	13	20	25	101	39	50	SM2x5	T06
D3T-1420-SP05	14	20	25	105	42	50		
D3T-14520-SP05	14,5	20	25	109	45	50		
D3T-1520-SP05	15	20	25	109	45	50		
D3T-15520-SP05	15,5	20	34	126	48	50		
D3T-1620-SP06	16	20	34	126	48	50	SM2,2x5	
D3T-16525-SP06	16,5	25	34	129	51	50		
D3T-1725-SP06	17	25	34	129	51	56		
D3T-17525-SP06	17,5	25	34	132	54	56		
D3T-1825-SP06	18	25	34	132	54	56		
D3T-18525-SP06	18,5	25	34	135	57	56		
D3T-1925-SP06	19	25	34	135	57	56		
D3T-19525-SP06	19,5	25	34	139	60	56		
D3T-2025-SP06	20	25	34	139	60	56		
D3T-20525-SP06	20,5	25	34	143	63	56		
D3T-2125-SP06	21	25	34	143	63	56	SM2,5x7	T08
D3T-21525-SP06	21,5	25	34	147	66	56		
D3T-2225-SP07	22	25	34	147	66	56		
D3T-22525-SP07	22,5	25	34	151	72	56		
D3T-2325-SP07	23	25	34	151	72	56		
D3T-23525-SP07	23,5	25	34	153	75	56		
D3T-2425-SP07	24	25	34	153	75	56		
D3T-24525-SP07	24,5	25	34	156	78	56		
D3T-2525-SP07	25	25	34	156	78	56		
D3T-25525-SP07	25,5	25	34	160	81	56		
D3T-2625-SP07	26	25	34	160	81	56	SM3,5x8	T15
D3T-26525-SP07	26,5	25	34	164	84	56		
D3T-2725-SP07	27	25	34	164	84	56		
D3T-27525-SP07	27,5	25	34	168	87	56		
D3T-2825-SP09	28	25	34	168	87	56		
D3T-28525-SP09	28,5	25	34	172	90	56		
D3T-2925-SP09	29	25	34	172	90	56		
D3T-29525-SP09	29,5	25	44	180	93	60		
D3T-3032-SP09	30	25	44	180	96	60		
D3T-3132-SP09	31	32	44	184	99	60		
D3T-3232-SP09	32	32	44	188	102	60		

# DEĞİŞTİRİLEBİLİR KARBÜR UÇ VE TAKIMLAR

## INDEXABLE DRILLS INSERTS

**SPGT Takımlar / D3T**  
**SPGT Tools D3T**

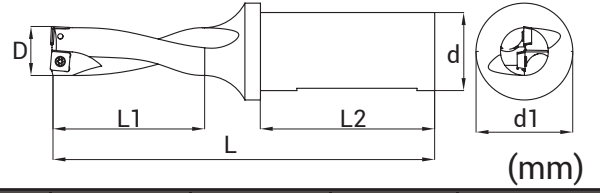

Takım Kodu Order Code	D	d	d1	L	L1	L2	Vida Screw	Anahtar Torx Key
D3T-3332-SP09	33	32	44	192	99	60	SM3,5X8	T15
D3T-3432-SP11	34	32	44	192	102	60	SM4X11	
D3T-3532-SP11	35	32	44	200	105	60		
D3T-3632-SP11	36	32	44	204	108	60		
D3T-3732-SP11	37	32	44	208	111	60		
D3T-3832-SP11	38	32	44	212	114	60		
D3T-38532-SP11	38,5	32	44	212	114	60		
D3T-3932-SP11	39	32	44	216	117	60		
D3T-4032-SP11	40	32	44	220	120	60		
D3T-4132-SP11	41	32	44	223	123	60		
D3T-41532-SP11	41,5	32	44	226	126	60	SM5X11	T20

**SPGT Takımlar / D4T**  
**SPGT Tools D4T**

Takım Kodu Order Code	D	d	d1	L	L1	L2	Vida Screw	Anahtar Torx Key
D4T-1320-SP05	13	20	25	120	52	50	SM2x5	T06
D4T-1420-SP05	14	20	25	124	56	50		
D4T-14520-SP05	14,5	20	25	128	60	50		
D4T-1520-SP05	15	20	25	128	60	50	SM2,2x5	
D4T-15520-SP05	15,5	20	25	128	62	50		
D4T-1620-SP06	16	25	34	142	64	50		
D4T-1725-SP06	17	25	34	146	68	56		
D4T-1825-SP06	18	25	34	150	72	56		
D4T-1925-SP06	19	25	34	154	76	56		
D4T-19525-SP06	19,5	25	34	159	80	56		
D4T-2025-SP06	20	25	34	159	80	56		
D4T-2125-SP06	21	25	34	164	84	56		
D4T-2225-SP07	22	25	34	169	88	56	SM2,5x7	T08
D4T-2325-SP07	23	25	34	174	92	56		
D4T-2425-SP07	24	25	34	177	96	56		
D4T-24525-SP07	24,5	25	34	181	100	56		
D4T-2525-SP07	25	25	34	181	100	56		
D4T-2625-SP07	26	25	34	186	104	56		
D4T-2725-SP07	27	25	34	191	108	56		
D4T-27525-SP07	27,5	25	34	196	112	56		
D4T-2825-SP09	28	25	34	196	112	56	SM3,5x8	T15
D4T-2925-SP09	29	25	34	201	116	56		
D4T-3032-SP09	30	32	44	210	120	60		
D4T-3132-SP09	31	32	44	215	124	60		
D4T-3232-SP09	32	32	44	220	128	60		
D4T-3332-SP09	33	32	44	225	132	60		
D4T-33532-SP09	33,5	32	44	230	136	60		
D4T-3432-SP11	34	32	44	230	136	60		
D4T-3532-SP11	35	32	44	235	140	60		

# DEĞİŞTİRİLEBİLİR KARBÜR UÇ VE TAKIMLAR

## INDEXABLE DRILLS INSERTS

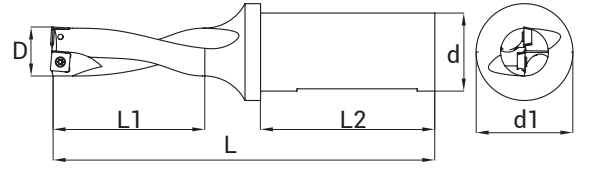

(mm)

**SPGT Takımlar / D4T**  
**SPGT Tools D4T**

Takım Kodu Order Code	D	d	d1	L	L1	L2	Vida Screw	Anahtar Torx Key
D4T-3632-SP11	36	32	44	238	144	60	SM4X11	T15
D4T-3732-SP11	37	32	44	241	148	60		
D4T-3832-SP11	38	32	44	244	152	60		
D4T-38532-SP11	38,5	32	44	247	156	60		
D4T-3932-SP11	39	32	44	247	156	60		
D4T-39532-SP11	39,5	32	44	247	156	60		
D4T-4032-SP11	40	32	44	250	160	60		
D4T-4132-SP11	41	32	44	253	164	60		

**SPGT Takımlar / D5T**  
**SPGT Tools D5T**

(mm)

Takım Kodu Order Code	D	d	d1	L	L1	L2	Vida Screw	Anahtar Torx Key
D5T-1625-SP06	16	25	34	153	80	50	SM2,2x5	T06
D5T-1725-SP06	17	25	34	158	85	56		
D5T-1825-SP06	18	25	34	163	90	56		
D5T-1925-SP06	19	25	34	168	95	56		
D5T-2025-SP06	20	25	34	174	100	56		
D5T-2125-SP06	21	25	34	180	105	56		
D5T-2225-SP07	22	25	34	186	110	56		
D5T-2325-SP07	23	25	34	192	115	56	SM2,5x7	T08
D5T-2425-SP07	24	25	34	196	120	56		
D5T-2525-SP07	25	25	34	200	125	56		
D5T-2625-SP07	26	25	34	206	130	56		
D5T-2725-SP07	27	25	34	212	135	56	SM3,5x8	T15
D5T-2825-SP09	28	25	34	218	140	56		
D5T-2925-SP09	29	25	34	224	145	56		
D5T-3032-SP09	30	32	44	233	150	60		

**Tavsiye Edilen Çalışma Koşulları**  
**Working Parameter Recommendation**

ISO	Materyal Grubu Material Group	Vc(m/min)	Ø12,5-15	Ø15,5-21,5	Ø22-27,5	Ø28-33	Ø34-41	Ø42-50
P	Karbon Çeliği Carbon Steel	180-250	0,05-0,08	0,06-0,10	0,06-0,12	0,07-0,13	0,08-0,15	0,08-0,16
	Düşük Alaşımli Çelik Low Alloy Steel	150-220	0,06-0,12	0,08-0,14	0,10-0,18	0,12-0,22	0,12-0,23	0,13-0,24
	Yüksek Alaşımli Çelik High Alloy Steel	130-180	0,06-0,10	0,08-0,15	0,10-0,20	0,12-0,23	0,12-0,24	0,13-0,25
M	Paslanmaz Çelik Stainless Steel	170-240	0,05-0,10	0,06-0,12	0,08-0,15	0,09-0,16	0,10-0,17	0,11-0,19
K	Gri Dökme Demir Gray Cast Iron	180-250	0,06-0,12	0,08-0,16	0,12-0,20	0,15-0,25	0,16-0,28	0,18-0,30
	Sfero Dökme Demir Nodular Cast Iron	130-200	0,06-0,10	0,08-0,15	0,10-0,18	0,12-0,20	0,15-0,23	0,16-0,25
N	Alaşımli Alüminyum Alloy Aluminum	330-380	0,06-0,14	0,08-0,15	0,10-0,20	0,12-0,22	0,14-0,23	0,15-0,26
S	Isıya Dirençli Alaşım Heat Resistant Alloy	30-60	0,05-0,10	0,06-0,14	0,08-0,18	0,10-0,22	0,12-0,22	0,14-0,24

# DEĞİŞTİRİLEBİLİR KARBÜR UÇ VE TAKIMLAR

## INDEXABLE DRILLS INSERTS

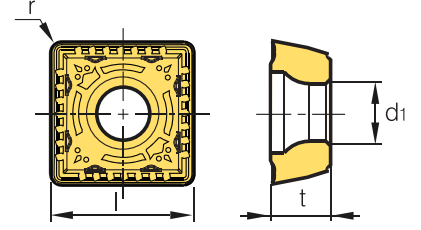

Ürün Görseli Product Image	CB	Uç Kodu Insert Code	C						Ölçüler Dimensions(mm)			
			TC1620	TC1630	TP2620	TP2630	TP3630	TP4630	TP5620	l	d	t
	PD	SPMT 040204							4,69	-	2,4	0,4
		SPMT 050204							5,1	-	2,4	0,4
		SPMT 060205							6,2	-	2,5	0,5
		SPMT 07T208							7,5	-	2,79	0,7
		SPMT 090308							9,19	-	3,3	0,8
		SPMT 11T308							11,0	-	4,0	0,8
		SPMT 130410							13,0	-	4,5	1,0
		SPMT 15M510							15,2	-	5,0	1,0
		SPMT 180510							18,2	-	5,49	1,0

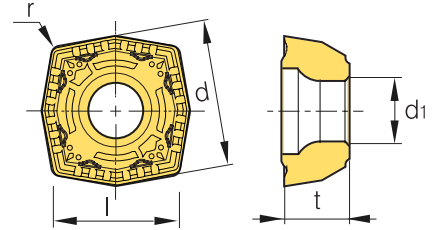

Ürün Görseli Product Image	CB	Uç Kodu Insert Code	C						Ölçüler Dimensions(mm)			
			TC1620	TC1630	TP2620	TP2630	TP3630	TP4630	TP5620	l	d	t
	PD	XOMT 040204							4,3	4,9	2,4	0,4
		XOMT 050204							4,79	5,4	2,4	0,4
		XOMT 060204							5,8	6,6	2,5	0,4
		XOMT 07T205							6,9	7,8	2,79	0,5
		XOMT 090305							8,39	9,6	3,3	0,5
		XOMT 11T306							10,0	11,4	4,0	0,6
		XOMT 130406							11,9	13,6	4,49	0,6
		XOMT 15M508							13,9	15,9	5,0	0,8
		XOMT 180508							16,5	18,9	5,5	0,8

# DEĞİŞTİRİLEBİLİR KARBÜR UÇ VE TAKIMLAR

## INDEXABLE DRILLS INSERTS

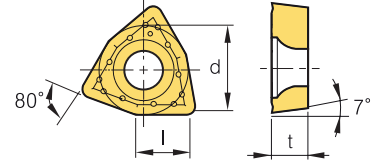

Ürün Görseli Product Image	CB	Uç Kodu Insert Code	U						Ölçüler Dimensions(mm)				
			TC1620	TC1630	TP2620	TP2630	TP3630	TP4630	TP5620	l	d	t	r
	FN	WCMX 030208R				●		●		3,8	5,56	2,38	2,8
		WCMX 040208R				●		●		4,3	6,35	2,38	3,1
		WCMX 050308T				●		●		5,4	7,94	3,18	3,2
		WCMX 06T308R				●		●		6,5	9,52	3,97	3,7
		WCMX 080412R				○		●		8,7	12,7	4,76	4,3

● Stok Ürün | Stock Item

○ Stok Dışı Ürün | Non Stock Item

□ Özel Ürün | Special Order

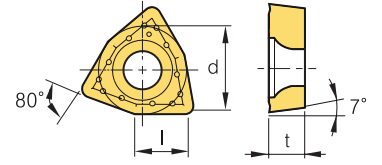

Ürün Görseli Product Image	CB	Uç Kodu Insert Code	H						Ölçüler Dimensions(mm)				
			TN7501						l	d	t	r	
	DA	WCKT 030208				●				3,8	5,56	2,38	2,8
		WCKT 040208				●				4,3	6,35	2,38	3,1
		WCKT 050308				●				5,4	7,94	3,18	3,2
		WCKT 06T308				●				6,5	9,525	3,97	3,7

● Stok Ürün | Stock Item

○ Stok Dışı Ürün | Non Stock Item

□ Özel Ürün | Special Order



# DEĞİŞTİRİLEBİLİR KARBÜR UÇ VE TAKIMLAR

## INDEXABLE DRILLS INSERTS

**WCMX Takımlar / D2G**  
**WCMX Tools / D2G**

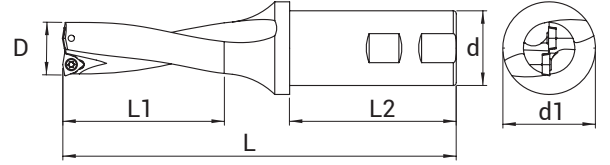

(mm)

Takım Kodu Order Code	D	d	d1	L	L1	L2	Vida Screw	Anahtar Torx Key
D2G-1625-WC03	16	25	34	110	32	50	SM2,5x5	T08
D2G-1725-WC03	17	25	34	112	34	56		
D2G-1825-WC03	18	25	34	114	36	56		
D2G-18525-WC03	18,5	25	34	114	36	56		
D2G-1925-WC03	19	25	34	116	38	56		
D2G-19525-WC03	19,5	25	34	116	38	56		
D2G-2025-WC04	20	25	34	119	40	56		
D2G-2125-WC04	21	25	34	122	42	56		
D2G-21525-WC04	21,5	25	34	122	42	56		
D2G-2225-WC04	22	25	34	125	44	56		
D2G-2325-WC04	23	25	34	128	46	56		
D2G-2425-WC05	24	25	34	129	48	56	SM3x9	T10
D2G-2525-WC05	25	25	34	131	50	56		
D2G-2625-WC05	26	25	34	134	52	56		
D2G-2725-WC05	27	25	34	137	54	56		
D2G-2825-WC05	28	25	34	140	56	56		
D2G-2925-WC05	29	25	34	143	58	56		
D2G-3032-WC06	30	32	44	150	60	60	SM3,5X9	T15
D2G-3132-WC06	31	32	44	153	62	60		
D2G-3232-WC06	32	32	44	156	64	60		
D2G-3332-WC06	33	32	44	159	66	60		
D2G-3432-WC06	34	32	44	162	68	60		
D2G-3532-WC06	35	32	44	165	70	60		
D2G-3632-WC06	36	32	44	168	72	60		
D2G-3732-WC06	37	32	44	171	74	60		
D2G-3832-WC06	38	32	44	174	76	60		
D2G-3932-WC06	39	32	44	177	78	60		
D2G-4032-WC06	40	32	44	180	80	60	SM3,5X9	T15
D2G-4132-WC06	41	32	44	183	82	60		
D2G-4232-WC06	42	32	44	186	84	60		
D2G-4332-WC06	43	32	44	189	86	60		
D2G-4432-WC06	44	32	44	192	88	60		
D2G-4540-WC08	45	54	54	195	90	70	SM4X11	T15
D2G-4640-WC08	46	54	54	198	92	70		
D2G-4740-WC08	47	54	54	201	94	70		
D2G-4840-WC08	48	54	54	204	96	70		
D2G-4940-WC08	49	54	54	207	98	70		
D2G-5040-WC08	50	54	54	210	100	70		

# DEĞİŞTİRİLEBİLİR KARBÜR UÇ VE TAKIMLAR

## INDEXABLE DRILLS INSERTS

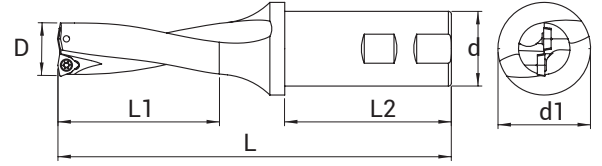

**WCMX Takımlar / D3G**  
**WCMX Tools / D3G**

(mm)

Takım Kodu Order Code	D	d	d1	L	L1	L2	Vida Screw	Anahtar Torx Key
D3G-15525-WC03	15,5	25	34	126	46,5	56	SM2,5x5	T10
D3G-1625-WC03	16	25	34	126	48	56		
D3G-16525-WC03	16,5	25	34	129	49,5	56		
D3G-1725-WC03	17	25	34	129	51	56		
D3G-17525-WC03	17,5	25	34	132	52,5	56		
D3G-1825-WC03	18	25	34	132	54	56		
D3G-18525-WC03	18,5	25	34	135	55,5	56		
D3G-1925-WC03	19	25	34	135	57	56		
D3G-19525-WC03	19,5	25	34	139	58,5	56		
D3G-2025-WC04	20	25	34	139	60	56		
D3G-20525-WC04	20,5	25	34	143	61,5	56		
D3G-2125-WC04	21	25	34	143	63	56		
D3G-21525-WC04	21,5	25	34	147	64,5	56		
D3G-2225-WC04	22	25	34	147	66	56		
D3G-22525-WC04	22,5	25	34	151	67,5	56		
D3G-2325-WC04	23	25	34	151	69	56		
D3G-23525-WC04	23,5	25	34	153	70,5	56		
D3G-2425-WC05	24	25	34	153	72	56		
D3G-24525-WC05	24,5	25	34	156	73,5	56		
D3G-2525-WC05	25	25	34	156	75	56		
D3G-25525-WC05	25,5	25	34	160	76,5	56		
D3G-2625-WC05	26	25	34	160	78	56		
D3G-26525-WC05	26,5	25	34	164	79,5	56		
D3G-2725-WC05	27	25	34	164	81	56		
D3G-27525-WC05	27,5	25	34	168	82,5	56		
D3G-2825-WC05	28	25	34	168	84	56		
D3G-28525-WC05	28,5	25	34	172	85,5	56		
D3G-2925-WC05	29	25	34	172	87	56		
D3G-29525-WC05	29,5	25	34	180	88,5	56		
D3G-3032-WC06	30	25	34	180	90	56	SM3,5X9	T15

# DEĞİŞTİRİLEBİLİR KARBÜR UÇ VE TAKIMLAR

## INDEXABLE DRILLS INSERTS

**WCMX Takımlar / D3G**  
**WCMX Tools / D3G**

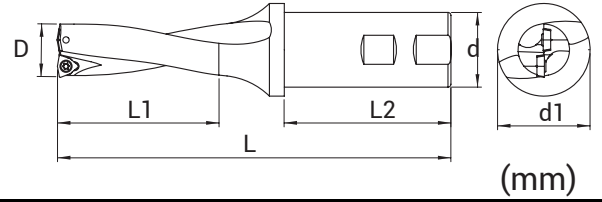

Takım Kodu Order Code	D	d	d1	L	L1	L2	Vida Screw	Anahtar Torx Key
D3G-3132-WC06	31	32	44	184	93	60	SM3,5X9	T15
D3G-3232-WC06	32	32	44	188	96	60		
D3G-3332-WC06	33	32	44	192	99	60		
D3G-3432-WC06	34	32	44	192	102	60		
D3G-3532-WC06	35	32	44	200	105	60		
D3G-3632-WC06	36	32	44	204	108	60		
D3G-3732-WC06	37	32	44	208	111	60		
D3G-3832-WC06	38	32	44	212	114	60		
D3G-3932-WC06	39	32	44	216	117	60		
D3G-4032-WC06	40	32	44	220	120	60		
D3G-4132-WC06	41	32	44	223	123	60		
D3G-4232-WC06	42	32	44	226	126	60		
D3G-4332-WC06	43	32	44	229	129	60		
D3G-4432-WC06	44	32	44	232	132	60		
D3G-4540-WC08	45	32	44	245	135	70	SM4X11	T15
D3G-4640-WC08	46	40	54	248	138	70		
D3G-4740-WC08	47	40	54	251	141	70		
D3G-4840-WC08	48	40	54	254	144	70		
D3G-4940-WC08	49	40	54	257	147	70		
D3G-5040-WC08	50	40	54	260	150	70		

**WCMX Takımlar / D4G**  
**WCMX Tools / D4G**

(mm)

Takım Kodu Order Code	D	d	d1	L	L1	L2	Vida Screw	Anahtar Torx Key		
D4G-1525-WC03	15,5	25	34	142	64	56	SM2,5x5	T08		
D4G-1625-WC03	16	25	34	142	64	56				
D4G-1725-WC03	17	25	34	146	68	56				
D4G-17525-WC03	17,5	25	34	150	72	56				
D4G-1825-WC03	18	25	34	150	72	56				
D4G-1925-WC03	19	25	34	154	76	56				
D4G-19525-WC03	19,5	25	34	159	80	56				
D4G-2025-WC04	20	25	34	159	80	56				
D4G-2125-WC04	21	25	34	164	84	56				
D4G-2225-WC04	22	25	34	169	88	56				
D4G-2325-WC04	23	25	34	174	92	56				
D4G-23525-WC04	23,5	25	34	174	92	56				
D4G-2425-WC05	24	25	34	177	96	56			SM3x9	T10
D4G-2525-WC05	25	25	34	181	100	56				
D4G-25525-WC05	25,5	25	34	181	100	56				
D4G-2625-WC05	26	25	34	186	104	56				
D4G-2725-WC05	27	25	34	191	108	56				
D4G-27525-WC05	28	25	34	196	112	56				
D4G-2825-WC05	28	25	34	196	112	56				
D4G-2925-WC05	29	25	34	201	116	56				

# DEĞİŞTİRİLEBİLİR KARBÜR UÇ VE TAKIMLAR

## INDEXABLE DRILLS INSERTS

**WCMX Takımlar / D4G**  
**WCMX Tools / D4G**

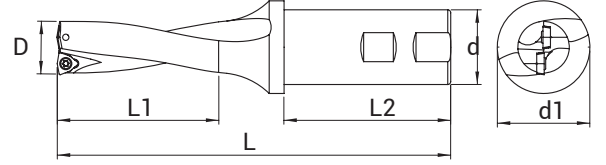

(mm)

Takım Kodu Order Code	D	d	d1	L	L1	L2	Vida Screw	Anahtar Torx Key
D4G-3032-WC06	30	32	44	210	120	56	SM3,5x9	T15
D4G-3132-WC06	31	32	44	215	124	60		
D4G-3232-WC06	32	32	44	220	128	60		
D4G-3332-WC06	33	32	44	225	132	60	SM3,5x11	
D4G-3432-WC06	34	32	44	230	136	60		
D4G-3532-WC06	35	32	44	235	140	60		
D4G-3632-WC06	36	32	44	238	144	60		
D4G-3732-WC06	37	32	44	241	148	60		
D4G-3832-WC06	38	32	44	244	152	60		
D4G-3932-WC06	39	32	44	247	166	60		
D4G-4032-WC06	40	32	44	250	160	60		
D4G-4132-WC06	41	32	44	253	164	60		
D4G-4232-WC06	42	32	44	256	168	60		
D4G-4332-WC06	43	32	44	259	172	60		
D4G-4432-WC06	44	32	44	262	176	60		
D4G-4540-WC08	45	40	54	266	180	60	SM4x11	
D4G-4640-WC08	46	40	54	270	184	60		
D4G-4740-WC08	47	40	54	274	188	60		
D4G-4840-WC08	48	40	54	278	192	60		
D4G-4940-WC08	49	40	54	282	196	60		
D4G-5040-WC08	50	40	54	286	200	60		

**WCMX Takımlar / D5G**  
**WCMX Tools / D5G**

(mm)

Takım Kodu Order Code	D	d	d1	L	L1	L2	Vida Screw	Anahtar Torx Key
D5G-1625-WC03	16	25	34	153	80	56	SM2,5x5	T08
D5G-1725-WC03	17	25	34	158	85	56		
D5G-1825-WC03	18	25	34	163	90	56		
D5G-1925-WC03	19	25	34	168	95	56		
D5G-2025-WC04	20	25	34	174	100	56		
D5G-2125-WC04	21	25	34	180	105	56		
D5G-2225-WC04	22	25	34	186	110	56		
D5G-2325-WC04	23	25	34	192	115	56		
D5G-2425-WC05	24	25	34	196	120	56	M3x9	T10
D5G-2525-WC05	25	25	34	200	125	56		
D5G-2625-WC05	26	25	34	206	130	56		
D5G-2725-WC05	27	25	34	212	135	56		
D5G-2825-WC05	28	25	34	218	140	56		
D5G-2925-WC05	29	25	34	224	145	56		
D5G-3032-WC06	30	32	44	233	150	60	SM3,5x9	T15

# DEĞİŞTİRİLEBİLİR KARBÜR UÇ VE TAKIMLAR

## INDEXABLE DRILLS INSERTS

 SPMT-XOMT Takımlar / D2K  
SPMT-XOMT Tools / D2K

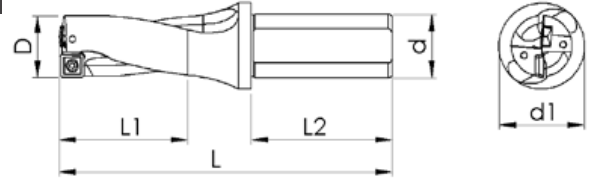

(mm)

Takım Kodu Order Code	D	d	d1	L	L1	L2	Vida Screw	Anahtar Torx Key
D2K-1625-SX05	16	25	34	110	32	50	SM2,2X5	T08
D2K-1725-SX06	17	25	34	112	34	56	SM2,2X6	
D2K-1825-SX06	18	25	34	114	36	56		
D2K-1925-SX06	19	25	34	116	38	56	SM3x7	
D2K-2025-SX07	20	25	34	119	40	56		
D2K-2125-SX07	21	25	34	122	42	56		
D2K-2225-SX07	22	25	34	125	44	56		
D2K-2325-SX07	23	25	34	128	46	56	SM3X7	T10
D2K-2425-SX09	24	25	34	129	48	56		
D2K-2525-SX09	25	25	34	131	50	56		
D2K-2625-SX09	26	25	34	134	52	56		
D2K-2725-SX09	27	25	34	137	54	56		
D2K-2825-SX09	28	25	34	140	56	56	SM3,5X9	T15
D2K-2925-SX09	29	25	34	143	58	56		
D2K-3032-SX11	30	32	44	150	60	60		
D2K-3132-SX11	31	32	44	153	62	60		
D2K-3232-SX11	32	32	44	156	64	60		
D2K-3332-SX11	33	32	44	159	66	60		
D2K-3432-SX11	34	32	44	162	68	60		
D2K-3532-SX11	35	32	44	165	70	60		

# DEĞİŞTİRİLEBİLİR KARBÜR UÇ VE TAKIMLAR

## INDEXABLE DRILLS INSERTS

 SPMT-XOMT Takımlar / D3K  
SPMT-XOMT Tools / D3K

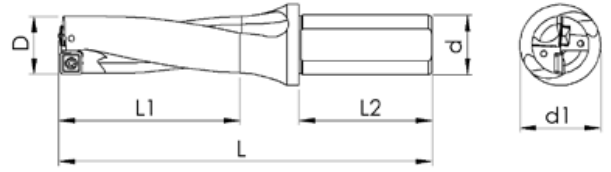

Takım Kodu Order Code	D	d	d1	L	L1	L2	Vida Screw	Anahtar Torx Key
D3K-1625-SX05	16	25	34	126	48	56	SM2,2X5	T08
D3K-1725-SX06	17	25	34	129	51	56	SM2,2X6	
D3K-1825-SX06	18	25	34	132	54	56		
D3K-1925-SX06	19	25	34	135	57	56	SM2,2X6	
D3K-2025-SX07	20	25	34	139	60	56		
D3K-2125-SX07	21	25	34	143	63	56		
D3K-2225-SX07	22	25	34	147	66	56	SM3X7	
D3K-2325-SX07	23	25	34	151	69	56		
D3K-2425-SX09	24	25	34	153	72	56		
D3K-2525-SX09	25	25	34	156	75	56		
D3K-2625-SX09	26	25	34	160	78	56		
D3K-2725-SX09	27	25	34	164	81	56		
D3K-2825-SX09	28	25	34	168	84	56		
D3K-2925-SX09	29	25	34	172	87	56	SM3,5X9	T15
D3K-3032-SX11	30	32	44	180	90	60		
D3K-3132-SX11	31	32	44	184	93	60		
D3K-3232-SX11	32	32	44	188	96	60		
D3K-3332-SX11	33	32	44	192	99	60		
D3K-3432-SX11	34	32	44	192	102	60		
D3K-3532-SX11	35	32	44	200	105	60		

# DEĞİŞTİRİLEBİLİR KARBÜR UÇ VE TAKIMLAR

## INDEXABLE DRILLS INSERTS

**SPMT-XOMT Takımlar / D4K**  
**SPMT-XOMT Tools / D4K**

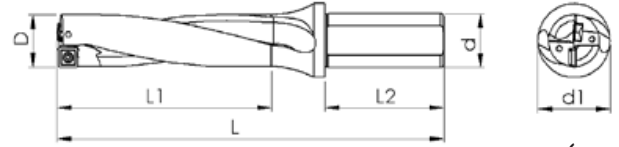

(mm)

Takım Kodu Order Code	D	d	d1	L	L1	L2	Vida Screw	Anahtar Torx Key
D4K-1625-SX05	16	25	34	142	64	50	SM2,2X5	T08
D4K-1725-SX06	17	25	34	146	68	56	SM2,2X6	
D4K-1825-SX06	18	25	34	150	72	56		
D4K-1925-SX06	19	25	34	154	76	56	SM2,2X6	
D4K-2025-SX07	20	25	34	159	80	56		
D4K-2125-SX07	21	25	34	164	84	56		
D4K-2225-SX07	22	25	34	169	88	56	SM3X7	
D4K-2325-SX07	23	25	34	174	92	56		
D4K-2425-SX09	24	25	34	177	96	56		
D4K-2525-SX09	25	25	34	181	100	56		
D4K-2625-SX09	26	25	34	186	104	56		
D4K-2725-SX09	27	25	34	191	108	56		
D4K-2825-SX09	28	25	34	196	112	56	SM3,5X9	T15
D4K-2925-SX09	29	25	34	201	116	56		
D4K-3032-SX11	30	32	44	210	120	60		
D4K-3132-SX11	31	32	44	215	124	60		
D4K-3232-SX11	32	32	44	220	128	60		
D4K-3332-SX11	33	32	44	225	132	60	SM3,5X9	T15
D4K-3432-SX11	34	32	44	230	136	60		
D4K-3532-SX11	35	32	44	235	140	60		

**SPMT-XOMT Takımlar / D5K**  
**SPMT-XOMT Tools / D5K**

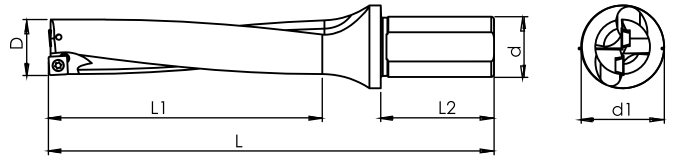

(mm)

Takım Kodu Order Code	D	d	d1	L	L1	L2	Vida Screw	Anahtar Torx Key
D5K-1825-SX06	18	25	34	163	90	56	SM2,2X6	T06
D5K-2025-SX07	20	25	34	174	100	56		
D5K-2225-SX07	22	25	34	186	110	56	SM2,2X7	T08
D5K-2625-SX09	26	25	34	206	130	56	SM2,5X7	

# DEĞİŞTİRİLEBİLİR KARBÜR UÇ VE TAKIMLAR

## INDEXABLE DRILLS INSERTS

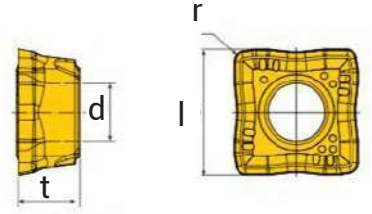
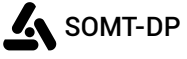

Ürün Görseli Product Image	CB	Uç Kodu Insert Code	U						Ölçüler Dimensions(mm)				
			TC1620	TC1630	TP2620	TP2630	TP3630	TP4630	TP5620	l	d	t	r
	DP	SOMT 050204		●						4,9	2,38	0,4	2,25
		SOMT 060204		●						5,7	2,38	0,4	2,60
		SOMT 070306		●						6,8	2,80	0,6	2,60
		SOMT 08T306		○						7,9	3,97	0,6	2,85
		SOMT 09T308		●						9,2	3,97	0,8	-
		SOMT 11T308		●						11,0	3,97	0,8	-

● Stok Ürün | Stock Item

○ Stok Dışı Ürün | Non Stock Item

□ Özel Ürün | Special Order

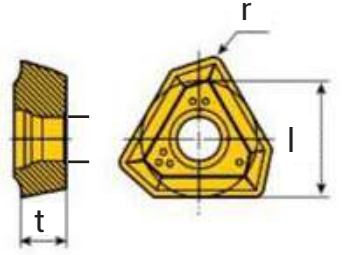

Ürün Görseli Product Image	CB	Uç Kodu Insert Code	U						Ölçüler Dimensions(mm)			
			TC1620	TC1630	TP2620	TP2630	TP3630	TP4630	TP5620	l	t	r
		TPMX 1403								8,45	3,5	0,4
		TPMX 1704								10,30	4,0	0,4
		TPMX 2405								14,20	5,5	0,4

● Stok Ürün | Stock Item

○ Stok Dışı Ürün | Non Stock Item

□ Özel Ürün | Special Order



# DEĞİŞTİRİLEBİLİR KARBÜR UÇ VE TAKIMLAR

## INDEXABLE DRILLS INSERTS

**SOMT Takımlar / 2D**  
**SOMT Tools / 2D**

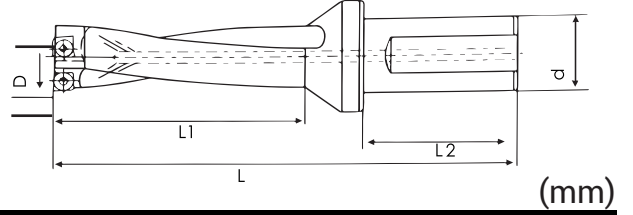

Takım Kodu Order Code	L	L1	L2	D	d	Vida Screw	Anahtar Torx Key
D2T-1388-SOMT05	88	29	44	13	20	M2X5	T06
D2T-13589-SOMT05	89	30		13,5			
D2T-1490-SOMT05	90	31		14			
D2T-14591-SOMT05	91	32		14,5			
D2T-1592-SOMT05	92	33		15			
D2T-15593-SOMT05	93	34		15,5			
D2T-1694-SOMT05	94	35		16			
D2T-16596-SOMT06	95	36		16,5			
D2T-1796-SOMT06	96	37		17			
D2T-175110-SOMT06	109	38		56			
D2T-18110-SOMT06	110	39	18				
D2T-185111-SOMT06	111	40	18,5				
D2T-19112-SOMT06	112	41	19				
D2T-195113-SOMT07	113	42	19,5				
D2T-20114-SOMT07	114	43	20				
D2T205115-SOMT07	115	44	20,5				
D2T-21116-SOMT07	116	45	21				
D2T-215117-SOMT07	117	46	21,5				
D2T-22118-SOMT07	118	47	22				
D2T-225119-SOMT08	119	48	60	22,5	32	M2,5X7	T08
D2T-23123-SOMT08	123	49		23			
D2T-235124-SOMT08	124	50		23,5			
D2T-24125-SOMT08	125	51		24			
D2T-245127-SOMT08	126	52		24,5			
D2T-25127-SOMT08	127	53		25			
D2T-255134-SOMT08	134	54		25,5			
D2T-26135-SOMT08	135	55		26			

# DEĞİŞTİRİLEBİLİR KARBÜR UÇ VE TAKIMLAR

## INDEXABLE DRILLS INSERTS

**SOMT Takımlar / 2D**  
**SOMT Tools / 2D**

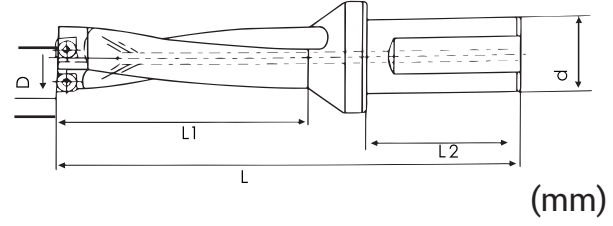

(mm)

Takım Kodu Order Code	L	L1	L2	D	d	Vida Screw	Anahtar Torx Key
D2T-265136-SOMT09	136	56	60	26,5	32	M4X10	T15
D2T-27137-SOMT09	137	57					
D2T-275138-SOMT09	138	58					
D2T-28139-SOMT09	139	59					
D2T-285140-SOMT09	140	60					
D2T-29143-SOMT09	143	62					
D2T-295144-SOMT09	144	63					
D2T-30148-SOMT09	148	64					
D2T-305149-SOMT09	149	65					
D2T-31150-SOMT09	150	66					
D2T-315151-SOMT09	151	67					
D2T-32152-SOMT11	152	68					
D2T-325153-SOMT11	153	69					
D2T-33154-SOMT11	154	70		60			
D2T-335155-SOMT11	155	71					
D2T-34156-SOMT11	156	72					
D2T-345157-SOMT11	157	73					
D2T-35158-SOMT11	158	74					
D2T-355159-SOMT11	159	75					
D2T-36160-SOMT11	160	76					
D2T-365161-SOMT11	161	77					
D2T-37169-SOMT13	169	79					
D2T-375170-SOMT13	170	80					
D2T-38171-SOMT13	171	81					
D2T-385172-SOMT13	172	82					
D2T-39174-SOMT13	173	83					
D2T-395185-SOMT13	174	84					
D2T-40185-SOMT13	185	85	70	40	40	M5X11	T20
D2T-41187-SOMT13	187	87					
D2T-42189-SOMT13	189	89					
D2T-43191-SOMT13	191	91					
D2T-44193-SOMT15	193	93					
D2T-45195-SOMT15	195	95					
D2T-46197-SOMT15	197	97					
D2T-47199-SOMT15	199	99					
D2T-48201-SOMT15	201	101					
D2T-49203-SOMT15	203	103					
D2T-50205-SOMT15	205	105					

# DEĞİŞTİRİLEBİLİR KARBÜR UÇ VE TAKIMLAR

## INDEXABLE DRILLS INSERTS

**SOMT Takımlar / 3D**  
**SOMT Tools / 3D**

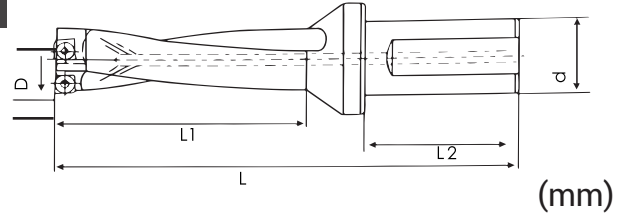

Takım Kodu Order Code	L	L1	L2	D	d	Vida Screw	Anahtar Torx Key
D3T-13101-SOMT05	101	42	44	13	20	M2X5	T06
D3T-135103-SOMT05	103	44		13,5			
D3T-14104-SOMT05	104	45		14			
D3T-145106-SOMT05	106	47		14,5			
D3T-15107-SOMT05	107	48		15			
D3T-155109-SOMT05	109	50		15,5			
D3T-16110-SOMT05	110	51		16			
D3T-165112-SOMT06	112	53		16,5			
D3T-17113-SOMT06	113	54	17	56	25	M2,2MX5	T07
D3T-175127-SOMT06	127	56	17,5				
D3T-18128-SOMT06	128	57	18				
D3T-185130-SOMT06	130	59	18,5				
D3T-19131-SOMT06	131	60	19				
D3T-195133-SOMT07	133	62	19,5				
D3T-20134-SOMT07	134	63	20				
D3T-205136-SOMT07	136	65	20,5				
D3T-21137-SOMT07	137	66	21				
D3T-215139-SOMT07	139	68	21,5				
D3T-22140-SOMT07	140	69	22	60	32	M2,5X7	T08
D3T-225142-SOMT08	142	71	22,5				
D3T-23146-SOMT08	146	72	23				
D3T-235148-SOMT08	148	74	23,5				
D3T-24149-SOMT08	149	75	24				
D3T-245151-SOMT08	151	77	24,5				
D3T-25152-SOMT08	152	78	25				
D3T-255160-SOMT08	160	8	25,5				
D3T-26161-SOMT08	161	81	26				

# DEĞİŞTİRİLEBİLİR KARBÜR UÇ VE TAKIMLAR

## INDEXABLE DRILLS INSERTS

**SOMT Takımlar / 3D**  
**SOMT Tools / 3D**

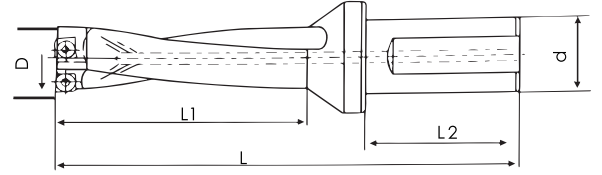

(mm)

Takım Kodu Order Code	L	L1	L2	D	d	Vida Screw	Anahtar Torx Key
D3T-265163-SOMT09	163	83	60	26,5	32	M3,5X8,5	T15
D3T-27164-SOMT09	164	84					
D3T-275166-SOMT09	166	86					
D3T-28167-SOMT09	167	87					
D3T-285169-SOMT09	169	89					
D3T-29172-SOMT09	172	91					
D3T-295174-SOMT09	174	93					
D3T-30178-SOMT09	178	94					
D3T-305180-SOMT09	180	96					
D3T-31181-SOMT09	181	97					
D3T-315183-SOMT09	183	99					
D3T-32184-SOMT11	184	100					
D3T-325186-SOMT11	186	102					
D3T-33187-SOMT11	187	103					
D3T-335189-SOMT11	189	105					
D3T-34190-SOMT11	190	106					
D3T-345192-SOMT11	192	108					
D3T-35193-SOMT11	193	109					
D3T-355195-SOMT11	195	111					
D3T-36196-SOMT11	196	112					
D3T-365198-SOMT11	198	114					
D3T-37206-SOMT13	206	116	70	37	40	M4X10	T15
D3T-375208-SOMT13	208	118					
D3T-38209-SOMT13	209	119					
D3T-385211-SOMT13	211	121					
D3T-39212-SOMT13	212	122					
D3T-395214-SOMT13	214	124					
D3T-40225-SOMT13	225	125					
D3T-41228-SOMT13	228	128					
D3T-42231-SOMT13	231	131					
D3T-43234-SOMT13	234	134					
D3T-44237-SOMT15	237	137	70	44	40	M5X11	T20
D3T-45240-SOMT15	240	140					
D3T-45243-SOMT15	243	143					
D3T-47246-SOMT15	246	146					
D3T-48249-SOMT15	249	149					
D3T-49252-SOMT15	252	152					
D3T-50255-SOMT15	255	155					

# DEĞİŞTİRİLEBİLİR KARBÜR UÇ VE TAKIMLAR

## INDEXABLE DRILLS INSERTS

**SOMT Takımlar / 4D**  
**SOMT Tools / 4D**

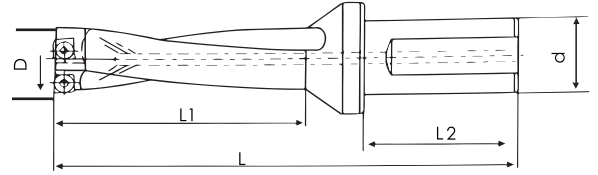

(mm)

Takım Kodu Order Code	L	L1	L2	D	d	Vida Screw	Anahtar Torx Key
D4T-14118-SOMT05	118	59	44	14	20	M2X5	T06
D4T-145120-SOMT05	120	61		14,5			
D4T15122-SOMT05	122	63		15			
D4T-155124-SOMT05	124	65		15,5			
D4T-16126-SOMT05	126	67		16			
D4T-165128-SOMT06	128	69		16,5			
D4T-17130-SOMT06	130	71		17			
D4T-175144-SOMT06	144	73	56	17,5	25	M2,2X5	T07
D4T-18146-SOMT06	146	75		18			
D4T-185148-SOMT06	148	77		18,5			
D4T-19150-SOMT06	150	79		19			
D4T-195152-SOMT07	152	81		19,5			
D4T-20154-SOMT07	154	83		20			
D4T-205156-SOMT07	156	85		20,5			
D4T-21158-SOMT07	158	87		21			
D4T-215160-SOMT07	160	89		21,5			
D4T-22162-SOMT07	162	91		22			
D4T-225164-SOMT08	164	93		22,5			
D4T-23169-SOMT08	169	95		23			
D4T-235171-SOMT08	171	97		23,5			
D4T-24173-SOMT08	173	99	24				
D4T-245175-SOMT08	175	101	24,5				
D4T-25177-SOMT08	177	103	25				
D4T-255185-SOMT08	185	105	60	25,5	32	M2,5X7	T08
D4T-26187-SOMT08	187	107		26			
D4T-265189-SOMT09	189	109		26,5			
D4T-27191-SOMT09	191	111		27			
						M3,5X8,5	T15

# DEĞİŞTİRİLEBİLİR KARBÜR UÇ VE TAKIMLAR

## INDEXABLE DRILLS INSERTS

**SOMT Takımlar / 4D**  
**SOMT Tools / 4D**

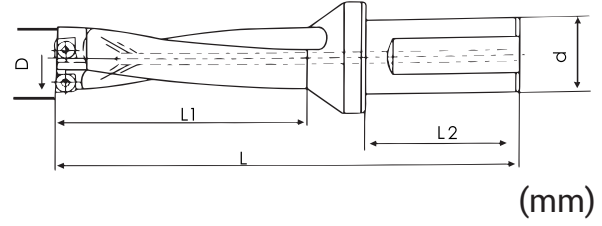

(mm)

Takım Kodu Order Code	L	L1	L2	D	d	Vida Screw	Anahtar Torx Key	
D4T-275193-SOMT09	193	113	60	27,5	32	M3,5X8,5	T15	
D4T-28195-SOMT09	195	115		28				
D4T-285197-SOMT09	197	117		28,5				
D4T-29201-SOMT09	201	120		29				
D4T-295203-SOMT09	203	122		29,5				
D4T-30208-SOMT09	208	124		30				
D4T-305210-SOMT09	210	126		30,5				
D4T-31212-SOMT09	212	128		31				
D4T-315214-SOMT09	214	130		31,5				
D4T-32216-SOMT11	216	132		32		40	M4X10	T15
D4T-325218-SOMT11	218	134		32,5				
D4T-33220-SOMT11	220	136		33				
D4T-335222-SOMT11	222	138		33,5				
D4T-34224-SOMT11	224	140		34				
D4T-345226-SOMT11	226	142		34,5				
D4T-35228-SOMT11	228	144		35				
D4T-355230-SOMT11	230	146		35,5				
D4T-36232-SOMT11	232	148		36				
D4T-365234-SOMT11	234	150	36,5	M5X11	T20			
D4T-37243-SOMT13	243	153	37					
D4T-375245-SOMT13	245	155	37,5					
D4T-38247-SOMT13	247	157	38					
D4T-385249-SOMT13	249	159	38,5					
D4T-39251-SOMT13	251	161	39					
D4T-395253-SOMT13	253	163	39,5					
D4T-40265-SOMT13	265	165	40					
D4T-41269-SOMT13	269	169	41					
D4T-42273-SOMT13	273	173	42					
D4T-43277-SOMT13	277	177	43					
D4T-44281-SOMT15	281	181	44					
D4T-45285-SOMT15	285	185	45					
D4T-46289-SOMT15	289	189	46					
D4T-47293-SOMT15	293	193	47					
D4T-48297-SOMT15	297	197	48					
D4T-49302-SOMT15	302	201	49					
D4T-50305-SOMT15	305	205	50					

# DEĞİŞTİRİLEBİLİR KARBÜR UÇ VE TAKIMLAR

## INDEXABLE DRILLS INSERTS

**SOMT Takımlar / 5D**  
**SOMT Tools / 5D**

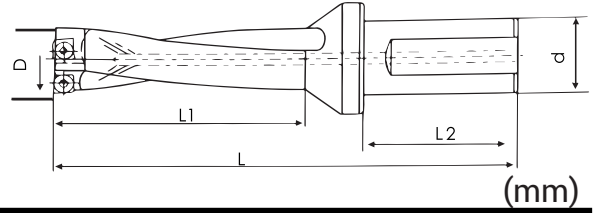

Takım Kodu Order Code	L	L1	L2	D	d	Vida Screw	Anahtar Torx Key
D5T-16142-SOMT05	142	83	44	16	20	M2X5	T06
D5T-165145-SOMT06	145	86		16,5			
D5T-17147-SOMT06	147	88		17			
D5T-175162-SOMT06	162	91	56	17,5	25	M2,2X5	T07
D5T-18164-SOMT06	164	93		18			
D5T185167-SOMT06	167	96		18,5			
D5T-19169-SOMT06	169	98		19			
D5T-195172-SOMT07	172	101		19,5			
D5T-20174-SOMT07	174	103		20			
D5T-205177-SOMT07	177	106		20,5			
D5T-21179-SOMT07	179	108		21			
D5T-215182-SOMT07	182	111		21,5			
D5T-22184-SOMT07	184	113		22			
D5T-225187-SOMT08	187	116		22,5			
D5T-23192-SOMT08	192	118	23	M2,5X7	T08		
D5T-235195-SOMT08	195	121	23,5				
D5T-24197-SOMT08	197	123	24				
D5T-245200-SOMT08	200	126	24,5				
D5T-25202-SOMT08	202	128	25				
D5T-255213-SOMT08	213	130	25,5				
D5T-26216-SOMT08	216	133	26				
D5T-265219-SOMT09	219	136	26,5	M3,5X8,5	T15		
D5T-27220-SOMT09	220	138	27				
D5T-275221-SOMT09	221	141	27,5				
D5T-28223-SOMT09	223	143	28				
D5T-285226-SOMT09	226	146	28,5				
D5T-29230-SOMT09	230	148	29				

# DEĞİŞTİRİLEBİLİR KARBÜR UÇ VE TAKIMLAR

## INDEXABLE DRILLS INSERTS

**SOMT Takımlar / 5D**  
**SOMT Tools / 5D**

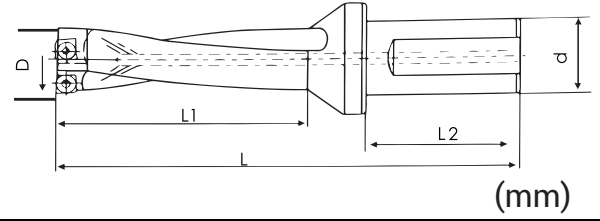

Takım Kodu Order Code	L	L1	L2	D	d	Vida Screw	Anahtar Torx Key
D5T-295233-SOMT09	233	151	60	29,5	32	M3,5X8,5	T15
D5T-30238-SOMT09	238	154		30			
D5T-305241-SOMT09	241	157		30,5			
D5T-31243-SOMT09	243	159		31			
D5T-315245-SOMT09	245	162		31,5			
D5T-32248-SOMT11	248	164		32			
D5T-325251-SOMT11	251	167		32,5			
D5T-33253-SOMT11	253	169		33			
D5T-335255-SOMT11	255	172		33,5			
D5T-34258-SOMT11	258	174		34			
D5T-345261-SOMT11	261	177		34,5			
D5T-35263-SOMT11	263	179		35			
D5T-355265-SOMT11	265	182		35,5			
D5T-36268-SOMT11	268	184		36			
D5T-365271-SOMT11	271	187		36,5			
D5T-37280-SOMT13	280	190		37			
D5T-375283-SOMT13	283	193		37,5			
D5T-38285-SOMT13	285	195		38			
D5T-385288-SOMT13	288	198		38,5			
D5T-39290-SOMT13	290	200	39				
D5T-395293-SOMT13	293	203	39,5				
D5T-40305-SOMT13	305	205	70	40	40	M4X10	T15
D5T-41310-SOMT13	310	210		41			
D5T-42315-SOMT13	315	215		42			
D5T-43320-SOMT13	320	220		43			
D5T-44325-SOMT15	325	225		44			
D5T-45330-SOMT15	330	230		45			
D5T-46335-SOMT15	335	235		46			
D5T-47340-SOMT15	340	240		47			
D5T-48345-SOMT15	345	245		48			
D5T-49350-SOMT15	350	250		49			
D5T-50355-SOMT15	355	255		50			



### ● Kolay Bağlama Sistemi Easy Clamping System

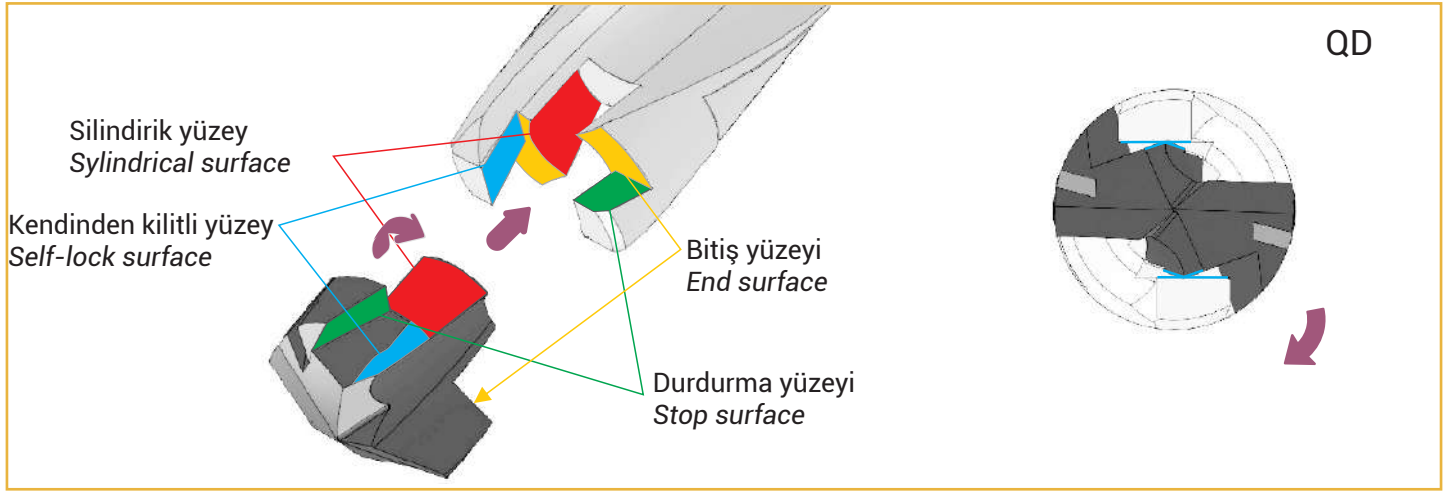

### ● Cilalanmış Takım Tutucular Polished Toolholders

Cilalanmış takım tutucu, talaşların kolayca tahliye edilmesini sağlar.

*Polished toolholder flutes let chips evacuate easily.*



### ● Soğutma Delikli Takım Tutucular Toolholders with Coolant Holes



Soğutma sıvısı kullanımı kesici uç ömrünü uzatır.  
Ayrıca basınç sayesinde talaşlar hızlı bir şekilde tahliye olur.

*Usage of coolant helps to sustain longer insert tool life. Also thanks to the pressure, chips are evacuated easily.*

### ● Değişirilebilirlik ve Esneklik Interchangeability and Flexibility

Farklı ölçüdeki kesici uçlar aynı tutucuda kullanılabildiği için Euroloy Rapid Drill işletmelere çok daha ekonomik bir çözüm sunar.

*Different inserts can be used with a single toolholder. This makes Euroloy Rapid Drills an economic solution for workshops.*

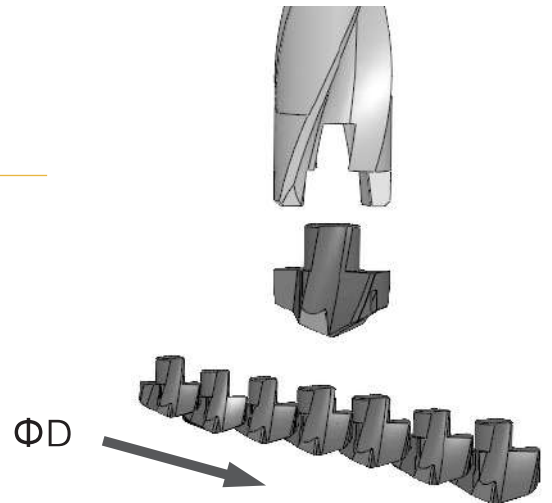

### Kesici Uçlar Nasıl Takılır? How to Attach Cutting Inserts?

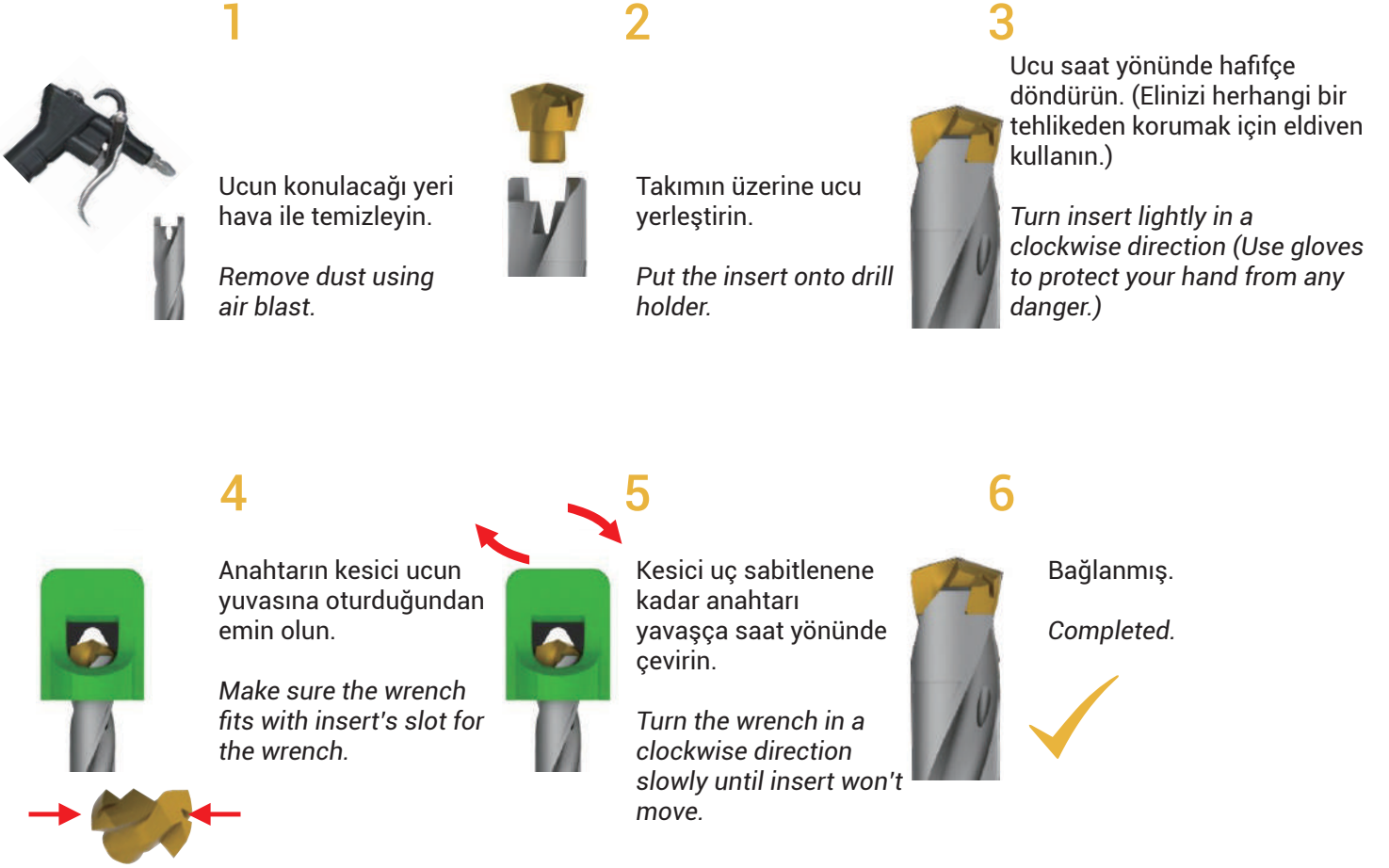

### Kesici Uçlar Nasıl Çıkarılır? How to Detach Cutting Inserts?

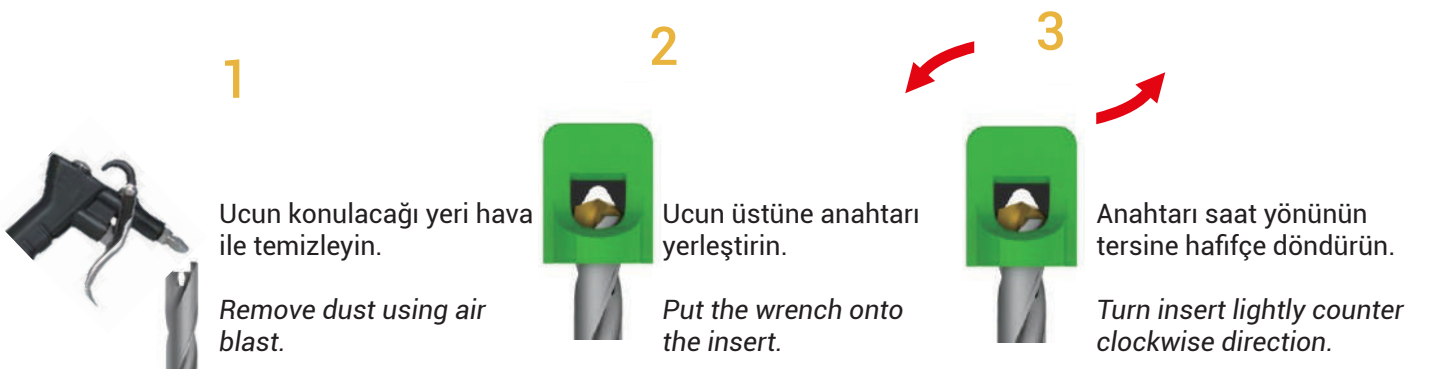

## Soğutma Sıvısı Coolant

1

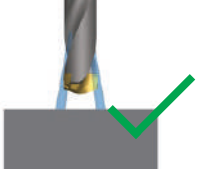

İçerden soğutma sıvısı kullanmanız tavsiye edilir.

*Strongly recommended to use inner coolant.*

2

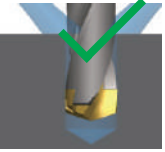

Eğer sadece dışarıdan soğutma kullanacaksanız, delikleri 3D'den daha az bir derinlikte delinir.

*If only outer coolant, just drill holes for less than 3D*

3



Kuru işleme tavsiye edilmez.

*Dry drilling is not recommended.*

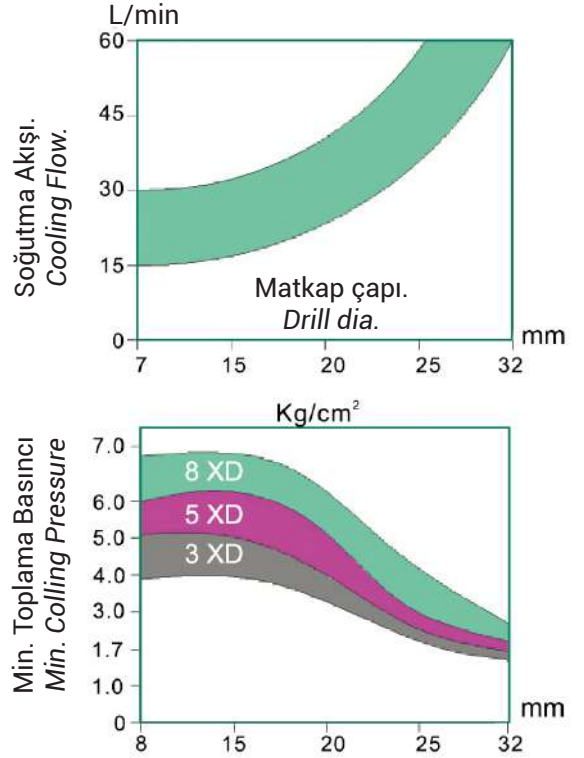

## Çekirdek Sapması Kullanımı İçin Dikkat Edilmesi Gerekenler Usage Precautions Core Deviation

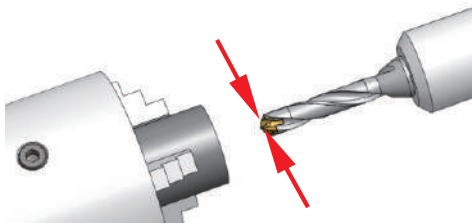

İş parçası ile matkap arasında 0,02mm'nin altında sapma miktarı ayarlayınız.

*Set deviation amount under 0,02mm between the workpiece and the drill.*

Deforme olmuş bir takma yüzeyi olan herhangi bir şaft kullanmayınız.  
Şaftın merkezi sapması 0,02mm içinde olmalıdır.

*Do not use any arbor with a deformed attachment surface.  
Center of arbor deviation must be within 0,02mm.*

Max. 0.02mm

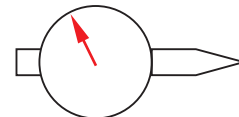

## Kesici Uçun Aşınma Belirtileri Indication of Insert Wear

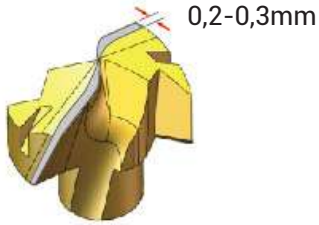

a) Aşınma Sınırı

Wear Limit

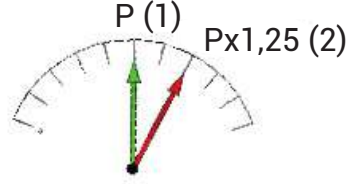

b) Güç Kısıtlaması

Power Restriction

1) Kullanılmamış kesici uç

1) New insert

2) Aşınmış uç için %25 arttırın

2) Increase 25% for worn-out insert

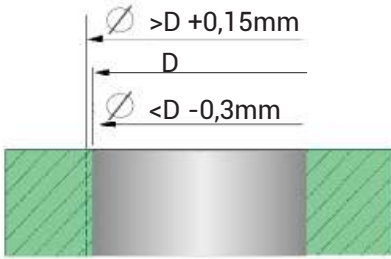

c) Çap değişikliği

Diameter change

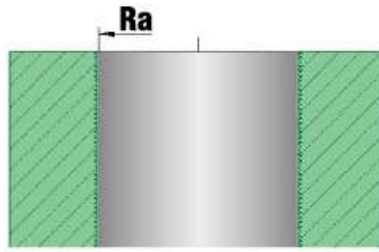

d) Yüzey kalitesinin bozulması

Surface finish deterioration



e) Titreşim gürültüsü ciddi şekilde artar

Vibration noise drastically increases

## Kesici Uç Aşınma Belirtileri Indication of Insert Wear

Doğru Uygulama  
Correct Application

İş Parçası Şekli  
Workpiece Shape

Hatalı Uygulama  
Incorrect Application

İş Parçası Şekli  
Workpiece Shape

Düz yüzey Flat face		Delik genişletme önerilmez. Hole expansion not	
Üstüste hizalanmış işparçaları Stacked plates		Eğimli yüzey önerilmez. Slanted surface not	
İçbükey yüzey (ilerleme hızının yarısını azaltmak normaldir.) Concave surface (reduce a half of feed rate is normal.)		Yarım silindirik şekil önerilmez. Half cylindrical not	
Boru malzemesi Pipe material		Çekirdekli delik önerilmez. Cored hole not	

## RAPID DRILL

## RAPID DRILL

### Delme Ucu Kodlama Sistemi Drilling Insert Coding System

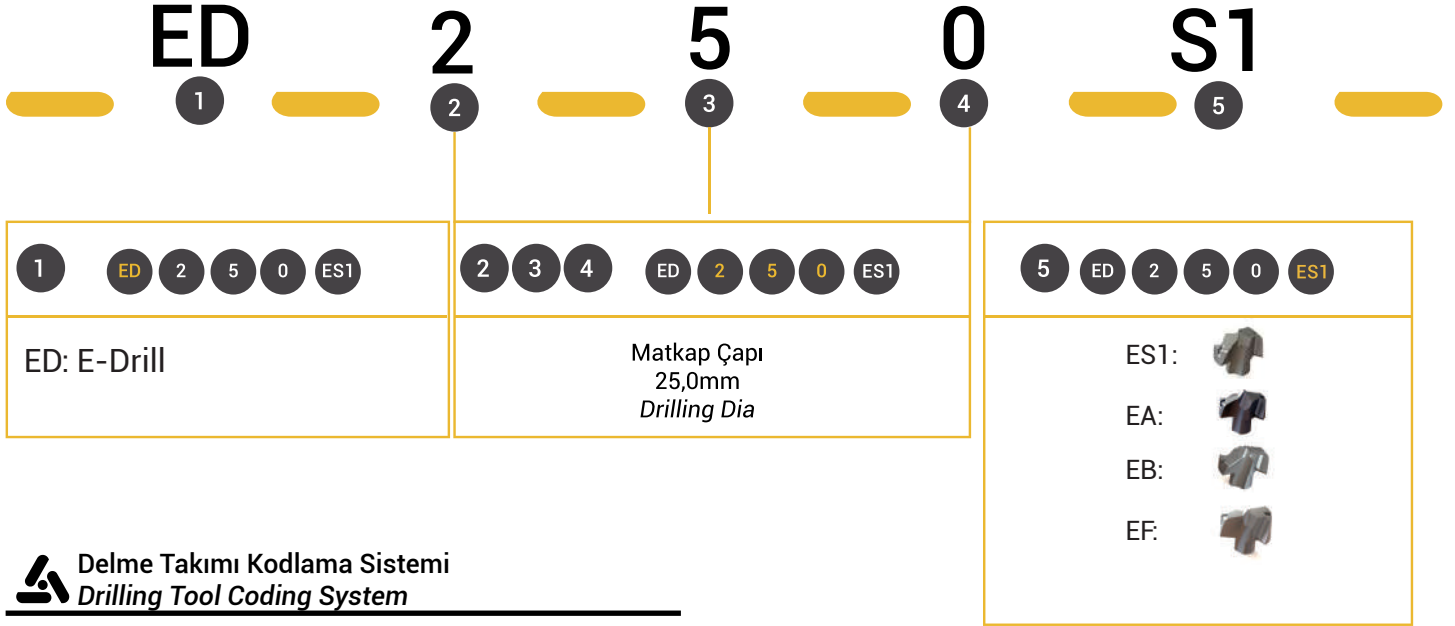

### Delme Takımı Kodlama Sistemi Drilling Tool Coding System

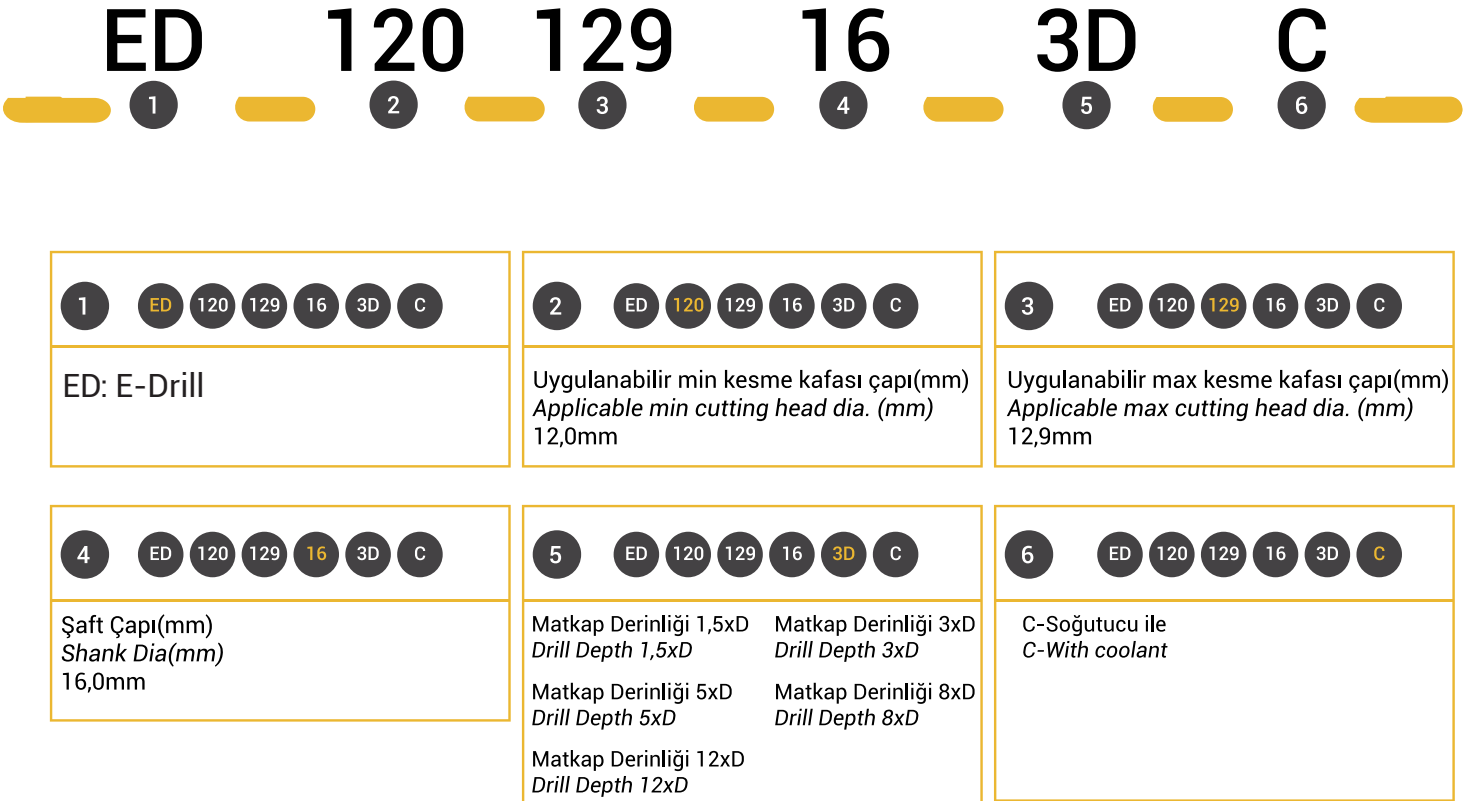

 **ES1 Standart Kesici Uç**  
**ES1 Standard Cutting Insert**

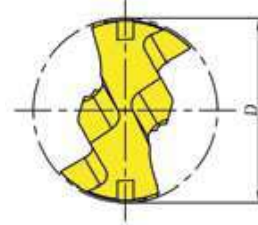
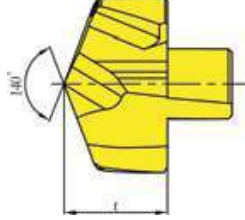

Uç Kodu Insert Code	Boyutlar Dimensions(mm)		Tutucu Kodu Holder Code
	D	t	
ED-080-ES1	8,0	5,4	ED080/089-12-..D- ..
ED-081-ES1	8,1	5,4	
ED-082-ES1	8,2	5,4	
ED-083-ES1	8,3	5,4	
ED-084-ES1	8,4	5,4	
ED-083-ES1	8,5	5,4	
ED-086-ES1	8,6	5,4	
ED-087-ES1	8,7	5,4	
ED-088-ES1	8,8	5,4	
ED-089-ES1	8,9	5,4	
ED-090-ES1	9,0	5,8	ED090/099-12-..D- ..
ED-091-ES1	9,1	5,8	
ED-092-ES1	9,2	18	
ED-093-ES1	9,3	5,8	
ED-094-ES1	9,4	18	
ED-095-ES1	9,3	18	
ED-096-ES1	9,6	5,8	
ED-097-ES1	9,7	18	
ED-098-ES1	9,8	5,8	
ED-099-ES1	9,9	18	
ED-100-ES1	10,0	6,2	ED100/109-16-..D- ..
ED-101-ES1	10,1	6,2	
ED-102-ES1	10,2	6,2	
ED-103-ES1	10,3	6,2	
ED-104-ES1	10,4	6,2	
ED-105-ES1	10,5	6,2	
ED-106-ES1	10,6	6,2	
ED-107-51	10,7	6,2	
ED-108-ES1	10,8	6,2	
ED-109-ES1	10,9	6,2	

Uç Kodu Insert Code	Boyutlar Dimensions(mm)		Tutucu Kodu Holder Code
	D	t	
ED-110-ES1	11,0	6,6	ED110/119-16-..D-..
ED-111-ES1	11,0	6,6	
ED-112-ES1	11,2	6,6	
ED-113-ES1	11,3	6,6	
ED-114-ES1	11,4	6,6	
ED-115-ES1	11,5	6,6	
ED-116-ES1	11,6	6,6	
ED-117-ES1	11,7	6,6	
ED-118-ES1	11,8	6,6	
ED-119-ES1	11,9	6,6	
ED-120-ES1	12,0	7,0	ED120/129-16-..D-..
ED-121-ES1	12,1	7,0	
ED-122-ES1	12,2	7,0	
ED-123-ES1	12,3	7,0	
ED-124-ES1	12,4	7,0	
ED-125-ES1	12,5	7,0	
ED-126-ES1	12,6	7,0	
ED-127-ES1	12,7	7,0	
ED-128-ES1	12,8	7,0	
ED-129-ES1	12,9	7,0	
ED-130-ES1	13,0	7,6	ED130/139-16-..D-..
ED-131-ES1	13,1	7,6	
ED-132-ES1	13,2	7,6	
ED-133-ES1	13,3	7,6	
ED-134-ES1	13,4	7,6	
ED-135-ES1	13,5	7,6	
ED-136-ES1	13,6	7,6	
ED-137-ES1	13,7	7,6	
ED-138-ES1	13,8	7,6	
ED-139-ES1	13,9	7,6	

Düşük ve yüksek karbonlu çelikler, alaşımlı çelikler, nodüler dökme demir (özellikle 5D'den daha küçük olan delme boylarında) ES1 kesici uç önerilir.

*ES1 insert is recommended for drilling low and high carbon steel, alloy steel, nodular cast iron (specifically for less than 5D).*

**ED...ES1 Standart Kesici Uç**  
**ED...ES1 Standard Cutting Insert**

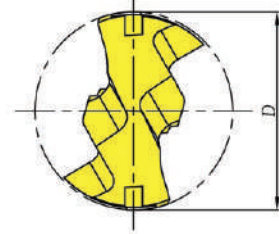
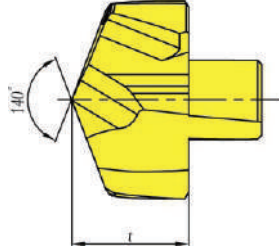
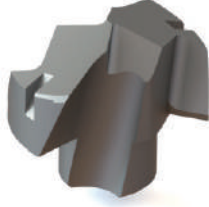

Uç Kodu Insert Code	Boyutlar Dimensions(mm)		Tutucu Kodu Holder Code
	D	t	
ED-140-ES1	14,0	8,1	ED140/149-16-..D-..
ED-141-ES1	14,1	8,1	
ED-142-ES1	14,2	8,1	
ED-143-ES1	14,3	8,1	
ED-144-ES1	14,4	8,1	
ED-145-ES1	14,5	8,1	
ED-146-ES1	14,6	8,1	
ED-147-ES1	14,7	8,1	
ED-148-ES1	14,8	8,1	
ED-149-ES1	14,9	8,1	
ED-150-ES1	15,0	8,7	EDM0169-20-..D-..
ED-151-ES1	15,1	8,7	
ED-152-ES1	15,2	8,7	
ED-153-ES1	15,3	8,7	
ED-154-ES1	15,4	8,7	
ED-155-ES1	15,5	8,7	
ED-156-ES1	15,6	8,7	
ED-157-ES1	15,7	8,7	
ED-158-ES1	15,8	8,7	
ED-159-ES1	15,9	8,7	
ED-160-ES1	16,0	9,3	ED160/169-20- D-..
ED-161-ES1	16,1	9,3	
ED-162-ES1	16,2	9,3	
ED-163-ES1	16,3	9,3	
ED-164-ES1	16,4	9,3	
ED-165-ES1	16,5	9,3	
ED-166-ES1	16,6	9,3	
ED-167-ES1	16,7	9,3	
ED-168-ES1	16,8	9,3	
ED-169-ES1	16,9	9,3	

Uç Kodu Insert Code	Boyutlar Dimensions(mm)		Tutucu Kodu Holder Code
	D	t	
ED-170-ES1	17,0	9,9	ED170/179-20-..D-..
ED-171-ES1	17,1	9,9	
ED-172-ES1	17,2	9,9	
ED-173-ES1	17,3	9,9	
ED-174-ES1	17,4	9,9	
ED-175-ES1	17,5	9,9	
ED-176-ES1	17,6	9,9	
ED-177-ES1	17,7	9,9	
ED-178-ES1	17,8	9,9	
ED-179-ES1	17,9	9,9	
ED-180-ES1	18,0	10,5	ED180/189-25-..D-..
ED-181-ES1	18,1	10,5	
ED-182-ES1	18,2	10,5	
ED-183-ES1	18,3	10,5	
ED-184-ES1	18,4	10,5	
ED-185-ES1	18,5	10,5	
ED-186-ES1	18,6	10,5	
ED-187-ES1	18,7	10,5	
ED-188-ES1	18,8	10,3	
ED-189-ES1	18,9	10,3	
ED-190-ES1	19,0	11,0	ED190/199-25- D-..
ED-191-ES1	19,1	11,0	
ED-192-ES1	19,2	11,0	
ED-193-ES1	19,3	11,0	
ED-194-ES1	19,4	11,0	
ED-195-ES1	19,5	11,0	
ED-196-ES1	19,6	11,0	
ED-197-ES1	19,7	11,0	
ED-198-ES1	19,8	11,0	
ED-199-ES1	19,9	11,0	

Orta ve yüksek karbonlu çelik, alaşım çeliği ve nodüler dökme demir (özellikle 5D'den daha az olanlar için) için ES1 kesici ucunun kullanılmasını öneririm.

*Recommended ES1 cutting insert to be used for middle and high carbon steel, alloy steel, nodular cast iron (speciallu for less than 5D)*



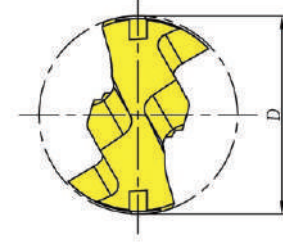
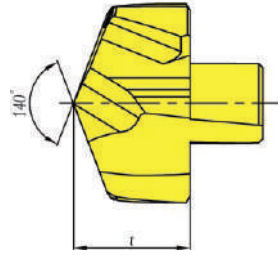
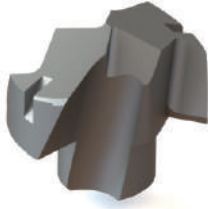

Uç Kodu Insert Code	Boyutlar Dimensions(mm)		Tutucu Kodu Holder Code	Uç Kodu Insert Code	Boyutlar Dimensions(mm)		Tutucu Kodu Holder Code
	D	t			D	t	
ED-200-ES1	20,0	11,6	ED200/209-25-..D- ..	ED-230-ES1	23,0	13,3	ED230/239-32-..D- ..
ED-201-ES1	20,1	11,6		ED-231-ES1	23,1	13,3	
ED-202-ES1	20,2	11,6		ED-232-ES1	23,2	13,3	
ED-203-ES1	20,3	11,6		ED-233-ES1	23,3	13,3	
ED-204-ES1	20,4	11,6		ED-234-ES1	23,4	13,3	
ED-205-ES1	20,5	11,6		ED-235-ES1	23,5	13,3	
ED-206-ES1	20,6	11,6		ED-236-ES1	23,6	13,3	
ED-207-ES1	20,7	11,6		ED-237-ES1	23,7	13,3	
ED-208-ES1	20,8	11,6		ED-238-ES1	23,8	13,3	
ED-209-ES1	20,9	11,6		ED-239-ES1	23,9	13,3	
ED-210-ES1	21,0	12,1	ED210/219-25-..D- ..	ED-240-ES1	24,0	13,9	ED240/249-32-..D- ..
ED-211-ES1	21,1	12,1		ED-241-ES1	24,1	13,9	
ED-212-ES1	21,2	12,1		ED-242-ES1	24,2	13,9	
ED-213-ES1	21,3	12,1		ED-243-ES1	24,3	13,9	
ED-214-ES1	21,4	12,1		ED-244-ES1	24,4	13,9	
ED-215-ES1	21,5	12,1		ED-245-ES1	24,5	13,9	
ED-216-ES1	21,6	12,1		ED-246-ES1	24,6	13,9	
ED-217-ES1	21,7	12,1		ED-247-ES1	24,7	13,9	
ED-218-ES1	21,8	12,1		ED-248-ES1	24,8	13,9	
ED-219-ES1	21,9	12,1		ED-249-ES1	24,9	13,9	
ED-220-ES1	22,0	12,7	ED220/229-25-..D- ..	ED-250-ES1	25,0	14,5	ED250/260-32-..D- ..
ED-221-ES1	22,1	12,7		ED-251-ES1	25,1	14,5	
ED-222-ES1	22,2	12,7		ED-252-ES1	25,2	14,5	
ED-223-ES1	22,3	12,7		ED-253-ES1	25,3	14,5	
ED-224-ES1	22,4	12,7		ED-254-ES1	25,4	14,5	
ED-225-ES1	22,5	12,7		ED-255-ES1	25,5	14,5	
ED-226-ES1	22,6	12,7		ED-256-ES1	25,6	14,5	
ED-227-ES1	22,7	12,7		ED-257-ES1	25,7	14,5	
ED-228-ES1	22,8	12,7		ED-258-ES1	25,8	14,5	
ED-229-ES1	22,9	12,7		ED-259-ES1	25,9	14,5	
				ED-260-ES1	26,0	14,5	

Orta ve yüksek karbonlu çelik, alaşım çeliği ve nodüler dökme demir (özellikle 5D'den daha az olanlar için) için ES1 kesici uç kullanılmasını öneririm.

Recommended ES1 cutting insert to be used for middle and high carbon steel, alloy steel, nodular cast iron (speciallu for less than 5D)



**ED...ES2 Standart Kesici Uç**  
**ED...ES2 Standard Cutting Insert**

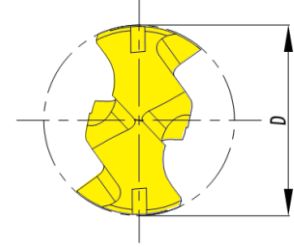
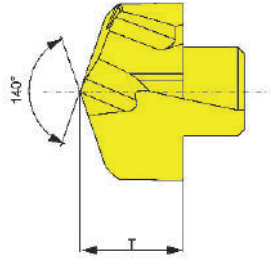

Uç Kodu Insert Code	Boyutlar Dimensions(mm)		Tutucu Kodu Holder Code	Uç Kodu Insert Code	Boyutlar Dimensions(mm)		Tutucu Kodu Holder Code
	D	t			D	t	
ED-080-ES2	8,0	5,4	ED080/089-12-..D-..	ED-110-ES2	11,0	6,6	E110/119-16-..D-..
ED-081-ES2	8,1	5,4		ED-111-ES2	11,1	6,6	
ED-082-ES2	8,2	5,4		ED-112-ES2	11,2	6,6	
ED-083-ES2	8,3	5,4		ED-113-ES2	11,3	6,6	
ED-084-ES2	8,4	5,4		ED-114-ES2	11,4	6,6	
ED-085-ES2	8,5	5,4		ED-115-ES2	11,5	6,6	
ED-086-ES2	8,6	5,4		ED-116-ES2	11,6	6,6	
ED-087-ES2	8,7	5,4		ED-117-ES2	11,7	6,6	
ED-088-ES2	8,8	5,4		ED-118-ES2	11,8	6,6	
ED-089-ES2	8,9	5,4		ED-119-ES2	11,9	6,6	
ED-090-ES2	9,0	5,8	ED090/099-12-..D-..	ED-120-ES2	12,0	7,0	ED120/129-16-..D-..
ED-091-ES2	9,1	5,8		ED-121-ES2	12,1	7,0	
ED-092-ES2	9,2	5,8		ED-122-ES2	12,2	7,0	
ED-093-ES2	9,3	5,8		ED-123-ES2	12,3	7,0	
ED-094-ES2	9,4	5,8		ED-124-ES2	12,4	7,0	
ED-095-ES2	9,5	5,8		ED-125-ES2	12,5	7,0	
ED-096-ES2	9,6	5,8		ED-126-ES2	12,6	7,0	
ED-097-ES2	9,7	5,8		ED-127-ES2	12,7	7,0	
ED-098-ES2	9,8	5,8		ED-128-ES2	12,8	7,0	
ED-099-ES2	9,9	5,8		ED-129-ES2	12,9	7,0	
ED-100-ES2	10,0	6,2	ED100/109-16-..D-..	ED-130-ES2	13,0	7,6	ED130/139-16-..D-..
ED-101-ES2	10,1	6,2		ED-131-ES2	13,1	7,6	
ED-102-ES2	10,2	6,2		ED-132-ES2	13,2	7,6	
ED-103-ES2	10,3	6,2		ED-133-ES2	13,3	7,6	
ED-104-ES2	10,4	6,2		ED-134-ES2	13,4	7,6	
ED-105-ES2	10,5	6,2		ED-135-ES2	13,5	7,6	
ED-106-ES2	10,6	6,2		ED-136-ES2	13,6	7,6	
ED-107-ES2	10,7	6,2		ED-137-ES2	13,7	7,6	
ED-108-ES2	10,8	6,2		ED-138-ES2	13,8	7,6	
ED-109-ES2	10,9	6,2		ED-139-ES2	13,9	7,6	

Gri dökme demir ve nodüler dökme demir malzeme işlemede ES2 karbür uç tavsiye edilir.

For machining gray cast iron and nodular cast iron, ES2 cutting insert is recommended.

**ED...ES2 Standart Kesici Uç**  
**ED...ES2 Standard Cutting Insert**

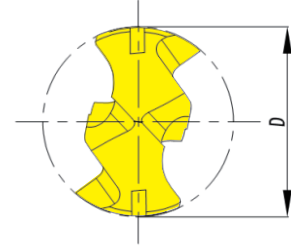
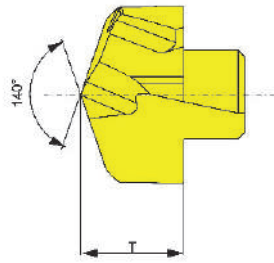

Uç Kodu Insert Code	Boyutlar Dimensions(mm)		Tutucu Kodu Holder Code
	D	t	
ED-140-ES2	14,0	8,1	ED140/149-16-..D- ..
ED-141-ES2	14,1	8,1	
ED-143-ES2	14,2	8,1	
ED-144-ES2	14,3	8,1	
ED-145-ES2	14,4	8,1	
ED-146-ES2	14,5	8,1	
ED-147-ES2	14,6	8,1	
ED-148-ES2	14,7	8,1	
ED-149-ES2	14,8	8,1	
ED-150-ES2	14,9	8,1	
ED-151-ES2	15,0	8,7	EDM0169-20-..D-..
ED-152-ES2	15,1	8,7	
ED-153-ES2	15,2	8,7	
ED-154-ES2	15,3	8,7	
ED-155-ES2	15,4	8,7	
ED-156-ES2	15,5	8,7	
ED-157-ES2	15,6	8,7	
ED-158-ES2	15,7	8,7	
ED-159-ES2	15,8	8,7	
ED-160-ES2	15,9	8,7	
ED-161-ES2	16,0	9,3	ED160/169-20- D-..
ED-162-ES2	16,1	9,3	
ED-163-ES2	16,2	9,3	
ED-164-ES2	16,3	9,3	
ED-165-ES2	16,4	9,3	
ED-166-ES2	16,5	9,3	
ED-167-ES2	16,6	9,3	
ED-168-ES2	16,7	9,3	
ED-169-ES2	16,8	9,3	
ED-170-ES2	16,9	9,3	

Uç Kodu Insert Code	Boyutlar Dimensions(mm)		Tutucu Kodu Holder Code
	D	t	
ED-170-ES2	17,0	9,9	ED170/179-20-..D- ..
ED-171-ES2	17,1	9,9	
ED-172-ES2	17,2	9,9	
ED-173-ES2	17,3	9,9	
ED-174-ES2	17,4	9,9	
ED-175-ES2	17,5	9,9	
ED-176-ES2	17,6	9,9	
ED-177-ES2	17,7	9,9	
ED-178-ES2	17,8	9,9	
ED-179-ES2	17,9	9,9	
ED-180-ES2	18,0	10,5	ED180/189-25-..D- ..
ED-181-ES2	18,1	10,5	
ED-182-ES2	18,2	10,5	
ED-183-ES2	18,3	10,5	
ED-184-ES2	18,4	10,5	
ED-185-ES2	18,5	10,5	
ED-186-ES2	18,6	10,5	
ED-187-ES2	18,7	10,5	
ED-188-ES2	18,8	10,5	
ED-189-ES2	18,9	10,5	
ED-190-ES2	19,0	11,0	ED190/199-25- D-..
ED-191-ES2	19,1	11,0	
ED-192-ES2	19,2	11,0	
ED-193-ES2	19,3	11,0	
ED-194-ES2	19,4	11,0	
ED-195-ES2	19,5	11,0	
ED-196-ES2	19,6	11,0	
ED-197-ES2	19,7	11,0	
ED-198-ES2	19,8	11,0	
ED-199-ES2	19,9	11,0	

Gri dökme demir ve nodüler dökme demir malzeme işlemede ES2 karbür uç tavsiye edilir.

For machining gray cast iron and nodular cast iron, ES2 cutting insert is recommended.

**ED...ES2 Standart Kesici Uç**  
**ED...ES2 Standard Cutting Insert**

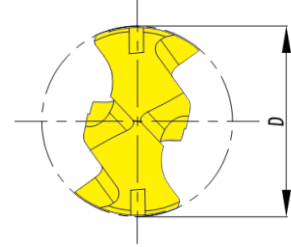
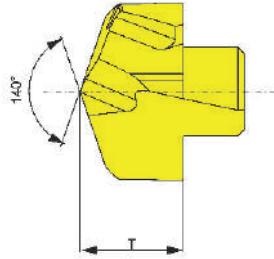

Uç Kodu Insert Code	Boyutlar Dimensions(mm)		Tutucu Kodu Holder Code	Uç Kodu Insert Code	Boyutlar Dimensions(mm)		Tutucu Kodu Holder Code
	D	t			D	t	
ED-200-ES2	20,0	11,6	ED200/209-25-..D- ..	ED-230-ES2	23,0	13,3	ED230/239-32-..D- ..
ED-201-ES2	20,1	11,6		ED-231-ES2	23,1	13,3	
ED-202-ES2	20,2	11,6		ED-232-ES2	23,2	13,3	
ED-203-ES2	20,3	11,6		ED-233-ES2	23,3	13,3	
ED-204-ES2	20,4	11,6		ED-234-ES2	23,4	13,3	
ED-205-ES2	20,5	11,6		ED-235-ES2	23,5	13,3	
ED-206-ES2	20,6	11,6		ED-236-ES2	23,6	13,3	
ED-207-ES2	20,7	11,6		ED-237-ES2	23,7	13,3	
ED-208-ES2	20,8	11,6		ED-238-ES2	23,8	13,3	
ED-209-ES2	20,9	11,6		ED-239-ES2	23,9	13,3	
ED-210-ES2	21,0	12,1	ED210/291-25-..D- ..	ED-240-ES2	24,0	13,9	ED240/249-32-..D- ..
ED-211-ES2	21,1	12,1		ED-241-ES2	24,1	13,9	
ED-212-ES2	21,2	12,1		ED-242-ES2	24,2	13,9	
ED-213-ES2	21,3	12,1		ED-243-ES2	24,3	13,9	
ED-214-ES2	21,4	12,1		ED-244-ES2	24,4	13,9	
ED-215-ES2	21,5	12,1		ED-245-ES2	24,5	13,9	
ED-216-ES2	21,6	12,1		ED-246-ES2	24,6	13,9	
ED-217-ES2	21,7	12,1		ED-247-ES2	24,7	13,9	
ED-218-ES2	21,8	12,1		ED-248-ES2	24,8	13,9	
ED-219-ES2	21,9	12,1		ED-249-ES2	24,9	13,9	
ED-220-ES2	22,0	12,7	ED220/229-25-..D- ..	ED-250-ES2	25,0	14,5	ED250/260-32-..D- ..
ED-221-ES2	22,1	12,7		ED-251-ES2	25,1	14,5	
ED-222-ES2	22,2	12,7		ED-252-ES2	25,2	14,5	
ED-223-ES2	22,3	12,7		ED-253-ES2	25,3	14,5	
ED-224-ES2	22,4	12,7		ED-254-ES2	25,4	14,5	
ED-225-ES2	22,5	12,7		ED-255-ES2	25,5	14,5	
ED-226-ES2	22,6	12,7		ED-256-ES2	25,6	14,5	
ED-227-ES2	22,7	12,7		ED-257-ES2	25,7	14,5	
ED-228-ES2	22,8	12,7		ED-258-ES2	25,8	14,5	
ED-229-ES2	22,9	12,7		ED-259-ES2	25,9	14,5	
				ED-260-ES2	26,0	14,5	

Gri dökme demir ve nodüler dökme demir için ES2 kesici uç kullanılmasını öneririm.

Recommended ES2 cutting insert to be used for grey iron cast, nodular cast iron.

**ED...EA Özel Kesici Uç**  
**ED...EA Special Cutting Insert**

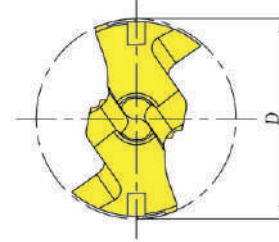
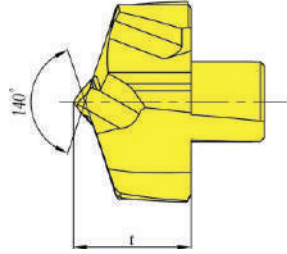

Uç Kodu Insert Code	Boyutlar Dimensions(mm)		Tutucu Kodu Holder Code
	D	t	
ED-080-EA	8,0	5,4	ED080/089-12-..D- ..
ED-081-EA	8,1	5,4	
ED-082-EA	8,2	5,4	
ED-083-EA	8,3	5,4	
ED-084-EA	8,4	5,4	
ED-085-EA	8,5	5,4	
ED-086-EA	8,6	5,4	
ED-087-EA	8,7	5,4	
ED-088-EA	8,8	5,4	
ED-089-EA	8,9	5,4	
ED-090-EA	9,0	5,8	ED090/099-12-..D- ..
ED-091-EA	9,1	5,8	
ED-092-EA	9,2	5,8	
ED-093-EA	9,3	5,8	
ED-094-EA	9,4	5,8	
ED-095-EA	9,5	5,8	
ED-096-EA	9,6	5,8	
ED-097-EA	9,7	5,8	
ED-098-EA	9,8	5,8	
ED-099-EA	9,9	5,8	
ED-100-EA	10,0	6,2	ED100/109-16-..D- ..
ED-101-EA	10,1	6,2	
ED-102-EA	10,2	6,2	
ED-103-EA	10,3	6,2	
ED-104-EA	10,4	6,2	
ED-105-EA	10,5	6,2	
ED-106-EA	10,6	6,2	
ED-107-EA	10,7	6,2	
ED-108-EA	10,8	6,2	
ED-109-EA	10,9	6,2	

Uç Kodu Insert Code	Boyutlar Dimensions(mm)		Tutucu Kodu Holder Code
	D	t	
ED-110-EA	11,0	6,6	ED110/119-16-..D- ..
ED-111-EA	11,1	6,6	
ED-112-EA	11,2	6,6	
ED-113-EA	11,3	6,6	
ED-114-EA	11,4	6,6	
ED-115-EA	11,5	6,6	
ED-116-EA	11,6	6,6	
ED-117-EA	11,7	6,6	
ED-118-EA	11,8	6,6	
ED-119-EA	11,9	6,6	
ED-120-EA	12,0	7,0	ED120/129-16-..D- ..
ED-121-EA	12,1	7,0	
ED-122-EA	12,2	7,0	
ED-123-EA	12,3	7,0	
ED-124-EA	12,4	7,0	
ED-125-EA	12,5	7,0	
ED-126-EA	12,6	7,0	
ED-127-EA	12,7	7,0	
ED-128-EA	12,8	7,0	
ED-129-EA	12,9	7,0	
ED-130-EA	13,0	7,6	ED130/139-16-..D- ..
ED-131-EA	13,1	7,6	
ED-132-EA	13,2	7,6	
ED-133-EA	13,3	7,6	
ED-134-EA	13,4	7,6	
ED-135-EA	13,5	7,6	
ED-136-EA	13,6	7,6	
ED-137-EA	13,7	7,6	
ED-138-EA	13,8	7,6	
ED-139-EA	13,9	7,6	

İnovatif geometri tasarımı sayesinde EA uçlar çok iyi merkezleme özelliğine sahiptir. Düşük ve yüksek karbonlu çelikler ve alaşımlı çeliklerde (özellikle 5D üzeri) tavsiye edilir.

*With its innovative geometry design, EA insert ensures excellent holde positioning through its self-centering point. EA insert can be used for machining low and high carbon steel, alloy steel (especially for more than 5D).*

**ED...EA Özel Kesici Uç**  
**ED...EA Special Cutting Insert**

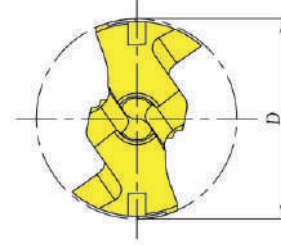
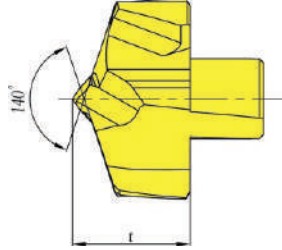

Uç Kodu Insert Code	Boyutlar Dimensions(mm)		Tutucu Kodu Holder Code
	D	t	
ED-140-EA	14,0	8,1	ED140/149-16-..D-..
ED-141-EA	14,1	8,1	
ED-142-EA	14,2	8,1	
ED-143-EA	14,3	8,1	
ED-144-EA	14,4	8,1	
ED-145-EA	14,5	8,1	
ED-146-EA	14,6	8,1	
ED-147-EA	14,7	8,1	
ED-148-EA	14,8	8,1	
ED-149-EA	14,9	8,1	
ED-150-EA	15,0	8,7	ED150/159-20-..D-..
ED-151-EA	15,1	8,7	
ED-152-EA	15,2	8,7	
ED-153-EA	15,3	8,7	
ED-154-EA	15,4	8,7	
ED-155-EA	15,5	8,7	
ED-156-EA	15,6	8,7	
ED-157-EA	15,7	8,7	
ED-158-EA	15,8	8,7	
ED-159-EA	15,9	8,7	
ED-160-EA	16,0	9,3	ED160/169-20-..D-..
ED-161-EA	16,1	9,3	
ED-162-EA	16,2	9,3	
ED-163-EA	16,3	9,3	
ED-164-EA	16,4	9,3	
ED-165-EA	16,5	9,3	
ED-166-EA	16,6	9,3	
ED-167-EA	16,7	9,3	
ED-168-EA	16,8	9,3	
ED-169-EA	16,9	9,3	

Uç Kodu Insert Code	Boyutlar Dimensions(mm)		Tutucu Kodu Holder Code
	D	t	
ED-170-EA	17,0	9,9	ED170/179-20-..D-..
ED-171-EA	17,1	9,9	
ED-172-EA	17,2	9,9	
ED-173-EA	17,3	9,9	
ED-174-EA	17,4	9,9	
ED-175-EA	17,5	9,9	
ED-176-EA	17,6	9,9	
ED-177-EA	17,7	9,9	
ED-178-EA	17,8	9,9	
ED-179-EA	17,9	9,9	
ED-180-EA	18,0	10,5	ED180/189-25-..D-..
ED-181-EA	18,1	10,5	
ED-182-EA	18,2	10,5	
ED-183-EA	18,3	10,5	
ED-184-EA	18,4	10,5	
ED-185-EA	18,5	10,5	
ED-186-EA	18,6	10,5	
ED-187-EA	18,7	10,5	
ED-188-EA	18,8	10,5	
ED-189-EA	18,9	10,5	
ED-190-EA	19,0	11,0	ED190/199-25-..D-..
ED-191-EA	19,1	11,0	
ED-192-EA	19,2	11,0	
ED-193-EA	19,3	11,0	
ED-194-EA	19,4	11,0	
ED-195-EA	19,5	11,0	
ED-196-EA	19,6	11,0	
ED-197-EA	19,7	11,0	
ED-198-EA	19,8	11,0	
ED-199-EA	19,9	11,0	

İnovatif geometri tasarımı sayesinde EA uçlar çok iyi merkezleme özelliğine sahiptir. Düşük ve yüksek karbonlu çelikler ve alaşımlı çeliklerde (özellikle 5D üzeri) tavsiye edilir.

*With its innovative geometry design, EA insert ensures excellent holde positioning through its self-centering point. EA insert can be used for machining low and high carbon steel, alloy steel (especially for more than 5D).*

**ED...EA Özel Kesici Uç**  
**ED...EA Special Cutting Insert**

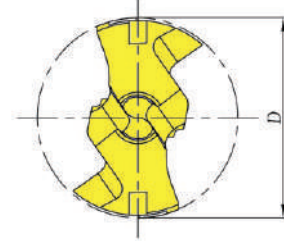
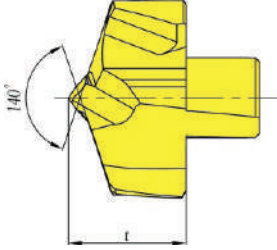

Uç Kodu Insert Code	Boyutlar Dimensions(mm)		Tutucu Kodu Holder Code
	D	t	
ED-200-EA	20,0	11,6	ED200/209-25-..D-..
ED-201-EA	20,1	11,6	
ED-202-EA	20,2	11,6	
ED-203-EA	20,3	11,6	
ED-204-EA	20,4	11,6	
ED-205-EA	20,5	11,6	
ED-206-EA	20,6	11,6	
ED-207-EA	20,7	11,6	
ED-208-EA	20,8	11,6	
ED-209-EA	20,9	11,6	
ED-210-EA	21,0	12,1	ED210/219-25-..D-..
ED-211-EA	21,1	12,1	
ED-212-EA	21,2	12,1	
ED-213-EA	21,3	12,1	
ED-214-EA	21,4	12,1	
ED-215-EA	21,5	12,1	
ED-216-EA	21,6	12,1	
ED-217-EA	21,7	12,1	
ED-218-EA	21,8	12,1	
ED-219-EA	21,9	12,1	
ED-220-EA	22,0	12,7	ED220/229-25-..D-..
ED-221-EA	22,1	12,7	
ED-222-EA	22,2	12,7	
ED-223-EA	22,3	12,7	
ED-224-EA	22,4	12,7	
ED-225-EA	22,5	12,7	
ED-226-EA	22,6	12,7	
ED-227-EA	22,7	12,7	
ED-228-EA	22,8	12,7	
ED-229-EA	22,9	12,7	

Uç Kodu Insert Code	Boyutlar Dimensions(mm)		Tutucu Kodu Holder Code
	D	t	
ED-230-EA	23,0	13,3	ED230/239-32-..D-..
ED-231-EA	23,1	13,3	
ED-232-EA	23,2	13,3	
ED-233-EA	23,3	13,3	
ED-234-EA	23,4	13,3	
ED-235-EA	23,5	13,3	
ED-236-EA	23,6	13,3	
ED-237-EA	23,7	13,3	
ED-238-EA	23,8	13,3	
ED-239-EA	23,9	13,3	
ED-240-EA	24,0	13,9	ED240/249-32-..D-..
ED-241-EA	24,1	13,9	
ED-242-EA	24,2	13,9	
ED-243-EA	24,3	13,9	
ED-244-EA	24,4	13,9	
ED-245-EA	24,5	13,9	
ED-246-EA	24,6	13,9	
ED-247-EA	24,7	13,9	
ED-248-EA	24,8	13,9	
ED-249-EA	24,9	13,9	
ED-250-EA	25,0	14,5	ED250/260-32-..D-..
ED-251-EA	25,1	14,5	
ED-252-EA	25,2	14,5	
ED-253-EA	25,3	14,5	
ED-254-EA	25,4	14,5	
ED-255-EA	25,5	14,5	
ED-256-EA	25,6	14,5	
ED-257-EA	25,7	14,5	
ED-258-EA	25,8	14,5	
ED-259-EA	25,9	14,5	
ED-260-EA	26,0	14,5	

İnovatif geometri tasarımı sayesinde EA uçlar çok iyi merkezleme özelliğine sahiptir. Düşük ve yüksek karbonlu çelikler ve alaşımlı çeliklerde (özellikle 5D üzeri) tavsiye edilir.

*With its innovative geometry design, EA insert ensures excellent holde positioning through its self-centering point. EA insert can be used for machining low and high carbon steel, alloy steel (especially for more than 5D)*

# RAPID DRILL

## RAPID DRILL

 ED...EF Düz Yüzey Kesici Uç  
ED...EF Flat Cutting Insert

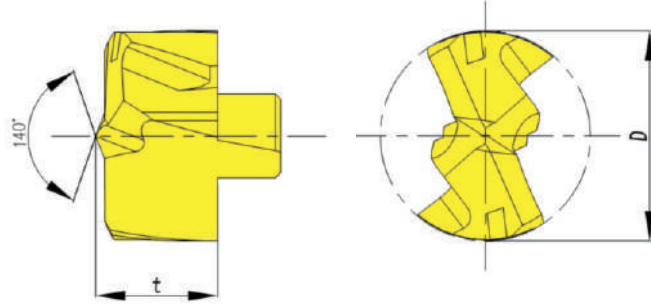

Uç Kodu Insert Code	Boyutlar Dimensions(mm)		Tutucu Kodu Holder Code
	D	t	
ED-080-EF	8,0	4,0	ED080-089-12-..D-..
ED-083-EF	8,5	4,0	
ED-090-EF	9,0	4,2	
ED-095-EF	9,5	4,2	ED090-099-12-..D-..
ED-100-EF	10,0	4,4	
ED-105-EF	10,5	4,4	ED100-109-16-..D-..
ED-110-EF	11,0	4,5	
ED-115-EF	11,5	4,5	ED110-119-16-..D-..
ED-120-EF	12,0	4,8	
ED-125-EF	12,5	4,8	ED120-129-16-..D-..
ED-130-EF	13,0	5,1	
ED-135-EF	13,5	5,1	ED130-139-16-..D-..
ED-140-EF	14,0	5,5	
ED-145-EF	14,5	5,5	ED140-149-16-..D-..
ED-150-EF	15,0	5,9	
ED-153-EF	15,5	5,9	ED150-159-20-..D-..
ED-160-EF	16,0	6,3	
ED-165-EF	16,5	6,3	ED160-169-20-..D-..
ED-170-EF	17,0	6,6	
ED-175-EF	17,5	6,6	ED170-179-20-..D-..
ED-180-EF	18,0	6,9	
ED-185-EF	18,5	6,9	ED180-189-25-..D-..
ED-190-EF	19,0	7,2	
ED-195-EF	19,5	7,2	ED190-199-25-..D-..
ED-200-EF	20,0	8,2	
ED-203-EF	20,5	8,2	ED200-209-25-..D-..
ED-210-EF	21,0	8,6	
ED-215-EF	21,5	8,6	ED210-219-2J-..D-..
ED-220-EF	22,0	8,9	
ED-223-EF	22,5	8,9	ED220-229-23-..D-..
ED-230-EF	23,0	9,3	
ED-235-EF	23,5	9,3	ED230-239-32-..D-..
ED-240-EF	24,0	9,7	
ED-245-EF	24,5	9,7	ED240-249-32-..D-..
ED-250-EF	25,0	10,1	
ED-255-EF	25,5	10,1	ED230-260-?2-..D-..
ED-260-EF	26,0	10,1	

EF tipi kesici uç çok çeşitli malzemelerde sıfırdan delik açma için kullanılabilir.

EF type inserts can be used for drilling blind flat holes.



**ED...EB Özel Kesici Uç**  
**ED...EB Special Cutting Insert**

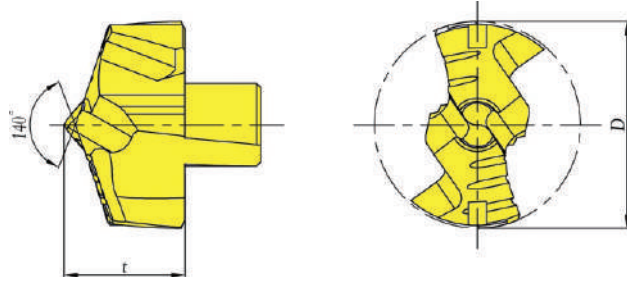
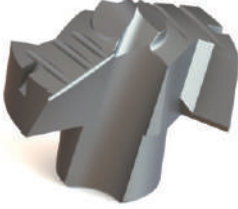

Uç Kodu Insert Code	Boyutlar Dimensions(mm)		Tutucu Kodu Holder Code
	D	t	
ED-080-EB	8,0	5,4	ED080/089-12-..D-..
ED-081-EB	8,1	5,4	
ED-082-EB	8,2	5,4	
ED-083-EB	8,3	5,4	
ED-084-EB	8,4	5,4	
ED-083-EB	8,5	5,4	
ED-086-EB	8,6	5,4	
ED-087-EB	8,7	5,4	
ED-088-EB	8,8	5,4	
ED-089-EB	8,9	5,4	
ED-090-EB	9,0	5,8	ED090/099-12-..D-..
ED-091-EB	9,1	5,8	
ED-092-EB	9,2	5,8	
ED-093-EB	9,3	5,8	
ED-094-EB	9,4	5,8	
ED-095-EB	9,5	5,8	
ED-096-EB	9,6	5,8	
ED-097-EB	9,7	5,8	
ED-098-EB	9,8	5,8	
ED-099-EB	9,9	5,8	
ED-100-EB	10,0	6,2	ED100/109-16-..D-..
ED-101-EB	10,1	6,2	
ED-102-EB	10,2	6,2	
ED-103-EB	10,3	6,2	
ED-104-EB	10,4	6,2	
ED-105-EB	10,5	6,2	
ED-106-EB	10,6	6,2	
ED-107-EB	10,7	6,2	
ED-108-EB	10,8	6,2	
ED-109-EB	10,9	6,2	

Uç Kodu Insert Code	Boyutlar Dimensions(mm)		Tutucu Kodu Holder Code
	D	t	
ED-110-EB	11,0	6,6	ED110/119-16-..D-..
ED-111-EB	11,1	6,6	
ED-112-EB	11,2	6,6	
ED-113-EB	11,3	6,6	
ED-114-EB	11,3	6,6	
ED-115-EB	11,3	6,6	
ED-116-EB	11,3	6,6	
ED-117-EB	11,3	6,6	
ED-118-EB	11,3	6,6	
ED-119-EB	11,3	6,6	
ED-120-EB	12,0	7,0	ED120/129-16-..D-..
ED-121-EB	12,1	7,0	
ED-122-EB	12,2	7,0	
ED-123-EB	12,3	7,0	
ED-124-EB	12,4	7,0	
ED-125-EB	12,5	7,0	
ED-126-EB	12,6	7,0	
ED-127-EB	12,7	7,0	
ED-128-EB	12,8	7,0	
ED-129-EB	12,9	7,0	
ED-130-EB	13,0	7,6	ED130/139-16-..D-..
ED-131-EB	13,1	7,6	
ED-132-EB	13,2	7,6	
ED-133-EB	13,3	7,6	
ED-134-EB	13,4	7,6	
ED-135-EB	13,5	7,6	
ED-136-EB	13,6	7,6	
ED-137-EB	13,7	7,6	
ED-138-EB	13,8	7,6	
ED-139-EB	13,9	7,6	

EB uçlar çok iyi merkezleme özelliğine sahiptir ve düşük kesme kuvvetiyle delik delme operasyonlarını tamamlayabilir. Paslanmaz çelik, titanyum, nikel bazlı alaşımlar, mangan çeliği gibi işlenmesi zor malzemeler için tavsiye edilir.

EB type insert ensures excellent hole positioning through its self-centering point and can drill with low cutting force. EA insert can be used for machining stainless steel, titanium, nickel based alloys, Mn steel.



**ED...EB Özel Kesici Uç**  
**ED...EB Special Cutting Insert**

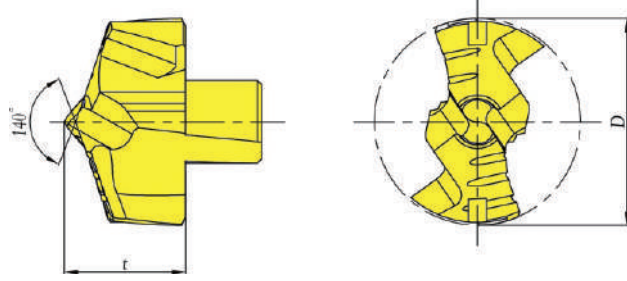
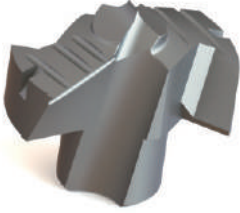

Uç Kodu Insert Code	Boyutlar Dimensions(mm)		Tutucu Kodu Holder Code
	D	t	
ED-140-EB	14	8,1	ED140/149-16-..D-..
ED-141-EB	14,1	8,1	
ED-142-EB	14,2	8,1	
ED-143-EB	14,3	8,1	
ED-144-EB	14,4	8,1	
ED-145-EB	14,5	8,1	
ED-146-EB	14,6	8,1	
ED-147-EB	14,7	8,1	
ED-148-EB	14,8	8,1	
ED-149-EB	14,9	8,1	
ED-150-EB	15,0	8,7	EDM0169-20-..D-..
ED-151-EB	15,1	8,7	
ED-152-EB	15,2	8,7	
ED-153-EB	15,3	8,7	
ED-154-EB	15,4	8,7	
ED-155-EB	15,5	8,7	
ED-156-EB	15,6	8,7	
ED-157-EB	15,7	8,7	
ED-158-EB	15,8	8,7	
ED-159-EB	15,9	8,7	
ED-160-EB	16,0	9,3	ED160169-20-..D-..
ED-161-EB	16,1	9,3	
ED-162-EB	16,2	9,3	
ED-163-EB	16,3	9,3	
ED-164-EB	16,4	9,3	
ED-165-EB	16,5	9,3	
ED-166-EB	16,6	9,3	
ED-167-EB	16,7	9,3	
ED-168-EB	16,8	9,3	
ED-169-EB	16,9	9,3	

Uç Kodu Insert Code	Boyutlar Dimensions(mm)		Tutucu Kodu Holder Code
	D	t	
ED-170-EB	17,0	9,9	ED170/179-20-..D-..
ED-171-EB	17,1	9,9	
ED-172-EB	17,2	9,9	
ED-173-EB	17,3	9,9	
ED-174-EB	17,4	9,9	
ED-175-EB	17,5	9,9	
ED-176-EB	17,6	9,9	
ED-177-EB	17,7	9,9	
ED-178-EB	17,8	9,9	
ED-179-EB	17,9	9,9	
ED-180-EB	18,0	10,5	ED180/189-25-..D-..
ED-181-EB	18,1	10,5	
ED-182-EB	18,2	10,5	
ED-183-EB	18,3	10,5	
ED-184-EB	18,4	10,5	
ED-185-EB	18,5	10,5	
ED-186-EB	18,6	10,5	
ED-187-EB	18,7	10,5	
ED-188-EB	18,8	10,5	
ED-189-EB	18,9	10,5	
ED-190-EB	19,0	11,0	ED190/199-25-..D-..
ED-191-EB	19,1	11,0	
ED-192-EB	19,2	11,0	
ED-193-EB	19,3	11,0	
ED-194-EB	19,4	11,0	
ED-195-EB	19,5	11,0	
ED-196-EB	19,6	11,0	
ED-197-EB	19,7	11,0	
ED-198-EB	19,8	11,0	
ED-199-EB	19,9	11,0	

EB uçlar çok iyi merkezleme özelliğine sahiptir ve düşük kesme kuvvetiyle delik delme operasyonlarını tamamlayabilir. Paslanmaz çelik, titanyum, nikel bazlı alaşımlar, mangan çeliği gibi işlenmesi zor malzemeler için tavsiye edilir.

*EB type insert ensures excellent hole positioning through its self-centering point and can drill with low cutting force. EA insert can be used for machining stainless steel, titanium, nickel based alloys, Mn steel.*

**ED...EB Özel Kesici Uç**  
**ED...EB Special Cutting Insert**

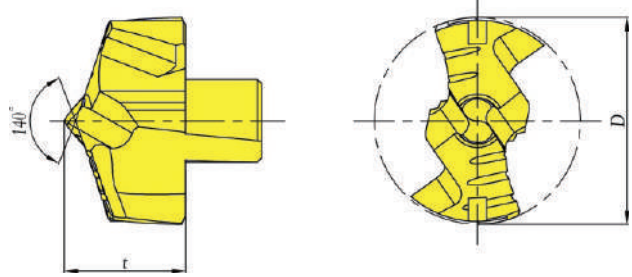
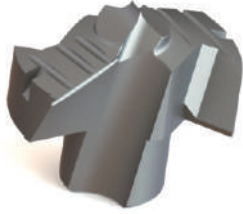

Uç Kodu Insert Code	Boyutlar Dimensions(mm)		Tutucu Kodu Holder Code
	D	t	
ED-200-EB	20,0	11,6	ED200/209-25-..D-..
ED-201-EB	20,1	11,6	
ED-202-EB	20,2	11,6	
ED-203-EB	20,3	11,6	
ED-204-EB	20,4	11,6	
ED-205-EB	20,5	11,6	
ED-206-EB	20,6	11,6	
ED-207-EB	20,7	11,6	
ED-208-EB	20,8	11,6	
ED-209-EB	20,9	11,6	
ED-210-EB	21,0	12,1	ED210/219-25-..D-..
ED-211-EB	21,1	12,1	
ED-212-EB	21,2	12,1	
ED-213-EB	21,3	12,1	
ED-214-EB	21,4	12,1	
ED-215-EB	21,5	12,1	
ED-216-EB	21,6	12,1	
ED-217-EB	21,7	12,1	
ED-218-EB	21,8	12,1	
ED-219-EB	21,9	12,1	
ED-220-EB	22,0	12,7	ED220/229-25- D-
ED-221-EB	22,1	12,7	
ED-222-EB	22,2	12,7	
ED-223-EB	22,3	12,7	
ED-224-EB	22,4	12,7	
ED-225-EB	22,5	12,7	
ED-226-EB	22,6	12,7	
ED-227-EB	22,7	12,7	
ED-228-EB	22,8	12,7	
ED-229-EB	22,9	12,7	

Uç Kodu Insert Code	Boyutlar Dimensions(mm)		Tutucu Kodu Holder Code
	D	t	
ED-230-EB	23,0	13,3	ED230/239-32-..D-..
ED-231-EB	23,1	13,3	
ED-232-EB	23,2	13,3	
ED-233-EB	23,3	13,3	
ED-234-EB	23,4	13,3	
ED-235-EB	23,5	13,3	
ED-236-EB	23,6	13,3	
ED-237-EB	23,7	13,3	
ED-238-EB	23,8	13,3	
ED-239-EB	23,9	13,3	
ED-240-EB	24,0	13,9	ED240/249-32-..D-..
ED-241-EB	24,1	13,9	
ED-242-EB	24,2	13,9	
ED-243-EB	24,3	13,9	
ED-244-EB	24,4	13,9	
ED-245-EB	24,5	13,9	
ED-246-EB	24,6	13,9	
ED-247-EB	24,7	13,9	
ED-248-EB	24,8	13,9	
ED-249-EB	24,9	13,9	
ED-250-EB	25,0	14,5	ED250/260-32- D-
ED-2J1-EB	25,1	14,5	
ED-252-EB	25,2	14,5	
ED-253-EB	25,3	14,5	
ED-254-EB	25,4	14,5	
ED-255-EB	25,5	14,5	
ED-256-EB	25,6	14,5	
ED-257-EB	25,7	14,5	
ED-258-EB	25,8	14,5	
ED-259-EB	25,9	14,5	
ED-260-EB	26,0	14,5	

EB uçlar çok iyi merkezleme özelliğine sahiptir ve düşük kesme kuvvetiyle delik delme operasyonlarını tamamlayabilir. Paslanmaz çelik, titanyum, nikel bazlı alaşımlar, mangan çeliği gibi işlenmesi zor malzemeler için tavsiye edilir.

*EB type insert ensures excellent hole positioning through its self-centering point and can drill with low cutting force. EA insert can be used for machining stainless steel, titanium, nickel based alloys, Mn steel.*

# RAPID DRILL

## RAPID DRILL

### ED...1,5D-CA Matkaplar ED...1,5D-CA Toolholders

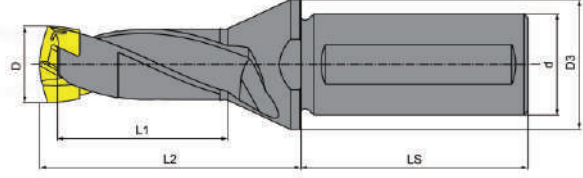

Ürün Kodu Order No	Uygulanabilir Kesim Kafa Çapı Applicable Cutting Head Dia	Boyutlar Dimensions(mm)					Anahtar Wrench
		d	D3	L1	Ls	D	
ED080/089-12-1,5D-CA	8,0~8,9	12	16	16	45	7,8	8-11,9
ED090/099-12-1,5D-CA	9,0~9,9	12	16	18	45	8,8	
ED100/109-16-1,5D-CA	10,0~10,9	16	20	20	48	9,8	
ED110/119-16-1,5D-CA	11,0~11,9	16	20	22	48	10,8	
ED120/129-16-1,5D-CA	12,0~12,9	16	20	24	48	11,8	12-16,9
ED130/139-16-1,5D-CA	13,0~13,9	16	20	25	48	12,8	
ED140/149-16-1,5D-CA	14,0~14,9	16	20	27	48	11,8	
ED150/159-20-1,5D-CA	15,0~15,9	20	25	29	50	14,8	
ED160/169-20-1,5D-CA	16,0~16,9	20	25	30	50	15,8	17-20,9
ED170/179-20-1,5D-CA	17,0~17,0	20	25	32	50	16,8	
ED180/189-23-1,5D-CA	18,0~18,9	25	32	34	56	17,8	
ED190/199-25-1,5D-CA	19,0~19,9	25	32	36	56	18,8	
ED200/209-25-1,5D-CA	20,0~20,9	25	32	38	56	19,8	21-26
ED210/219-23-1,5D-CA	21,0~21,9	25	32	40	56	20,8	
ED220/229-2S-1,5D-CA	22,0~22,9	25	32	42	56	21,8	
ED230/239-32-1,5D-CA	23,0~23,9	32	42	43	60	22,8	
ED240/249-32-1,5D-CA	24,0~24,9	32	42	45	60	23,8	
ED250/260-32-1,5D-CA	25,0~26,0	32	42	47	60	24,8	
inch	inch	inch	mm	mm	mm	mm	
ED/16-11/32-1/2-1,5D-CA	5/16~11/32	1/2	16	16	45	7,5	8-11,9
ED23/64-25/64-1/2-1,5D-CA	23/64~25/64	1/2	16	18	4S	8,8	
ED13/32-27/64-5/8-1,5D-CA	13/32~27/64	5/8	20	20	48	9,9	
ED7/16-15/32-5/8-1,5D-CA	7/16~15/32	5/8	20	22	48	10,7	
ED31/64-1/2-5/8-1,5D-CA	31/64~1/2	5/8	20	24	48	11,9	12-16,9
ED33/64-35/64-1/2-1,5D-CA	33/64~35/64	5/8	20	25	48	12,6	
ED9/16-37/64-1/2-1,5D-CA	9/16~37/64	5/8	25	27	48	13,8	
ED19/32-5/8-3/4-1,5D-CA	19/32~5/8	3/4	25	29	30	14,5	
ED41/64-21/32-3/4-1,5D-CA	41/64~21/32	3/4	25	30	50	15,6	17-20,9
ED43/64-45/64-3/4-1,5D-CA	43/64~45/64	3/4	2S	32	50	16,7	
ED23-32/47/64-1-11,5D-CA	23/32~47/64	1	32	34	36	17,6	
ED3/8-25/32-1-1,5D-CA	3/8~25/32	1	32	36	36	18,4	
ED51/64-13/16-1-1,5D-CA	51/64~13/16	1	32	38	56	19,6	21-26
ED53/64-55/64-1-1,5D-CA	53/64~55/64	1	32	40	56	20,4	
ED7/8-57/64-1-1,5D-CA	7/8~57/64	1	32	42	56	21,6	
ED29/32-59/64-1 1/4-1,5D-	29/32~59/64	1 1/4	42	43	60	22,4	
ED/61/64-31/32-1 1/4-1,5D-	61/64~1/32	1 1/4	42	45	60	23,6	21-26
ED63/64-1-1 1/4-1,5D-CA	63/64~1	1 1/4	42	47	60	24,4	

# RAPID DRILL

## RAPID DRILL

**ED...1,5D-CA Matkaplar**  
**ED...1,5D-CA Toolholders**

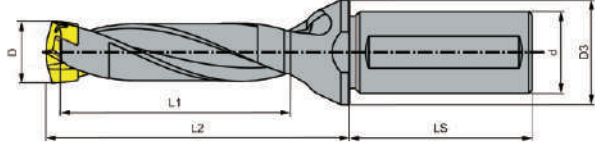

Ürün Kodu Order No	Uygulanabilir Kesim Kafa Çapı Applicable Cutting Head Dia	Boyutlar Dimensions(mm)					Anahtar Wrench
		d	D3	L1	Ls	D	
ED080/089-12-3D-CA	8,0~8,9	12	16	1	45	7,8	8-11,9
ED090/099-12-3D-CA	9,0~9,9	12	16	35	45	8,8	
ED100/109-16-3D-CA	10,0~10,9	16	20	39	48	9,8	
ED110/119-16-3D-CA	11,0~11,9	16	20	42	48	10,8	
ED120/129-16-3D-CA	12,0~12,9	16	20	45	48	11,8	12-16,9
ED130/139-16-3D-CA	13,0~13,9	16	20	49	48	12,8	
ED140/149-16-3D-CA	14,0~14,9	16	20	53	48	13,8	
ED150/159-20-3D-CA	15,0~15,9	20	25	56	50	14,8	
ED160/169-20-3D-CA	16,0~16,9	20	25	60	50	15,8	
ED170/179-20-3D-CA	17,0~17,9	20	25	63	50	16,8	17-20,9
ED180/189-25-3D-CA	18,0~18,9	25	25	66	56	17,8	
ED190/199-25-3D-CA	19,0~19,9	25	32	70	56	18,8	
ED200/209-25-3D-CA	20,0~20,9	25	32	73	56	19,8	
ED210/219-25-3D-CA	21,0~21,9	23	32	77	56	20,8	21-26
ED220/229-25-3D-CA	22,0~22,9	25	32	80	56	21,8	
ED230/239-32-3D-CA	23,0~23,9	32	42	84	60	22,8	
ED240/249-32-3D-CA	24,0~24,9	32	42	88	60	23,8	
ED250/260-32-3D-CA	25,0~26,0	32	42	91	60	24,8	
	inch	inch	mm	mm	mm	mm	
ED5/16-11/32-1/2-3D-CA	5/16~11/32	1/2	16	32	45	7,5	8-11,9
ED23/64-25/64-1/2-3D-CA	23/64~25/64	1/2	16	32	45	8,8	
ED13/32-27/64-5/8-3D-CA	13/32~7/64	3/8	20	39	48	9,9	
ED7/16-15/32-5/8-3D-CA	7/16~15/32	5/8	20	42	48	10,7	
ED31/64-1/2-3/8-3D-CA	31/64~1/2	3/8	20	42	48	11,9	12-16,9
ED33/64-35/64-1/2-3D-CA	33/64~35/64	5/8	20	42	48	12,6	
ED9/16-37/64-1/2-3D-CA	9/16~37/64	3/8	25	53	48	13,8	
ED19/32-3/8-3/4-3D-CA	19/32~5/8	3/4	25	56	50	14,5	
ED41/64-21/32-3/4-3D-CA	41/64~21/32	3/4	23	60	50	15,6	
ED43/64-45/64-3/4-3D-CA	43/64~21/32	3/4	25	63	50	16,7	17-20,9
ED23/32-47/64-1-3D-CA	43/64~45/64	1	32	66	56	17,6	
ED3/8-25/32-1-3D-CA	23/32~47/64	1	32	70	56	18,4	
ED61/64-13/161-3D-CA	3/8~25/32	1	32	73	56	19,6	
ED55/64-55/641-3D-CA	51/64~13/16	1	32	77	56	20,4	21-26
ED7/8-57/641-3D-CA	53/64~55/64	1	32	80	56	21,6	
ED29/32-59/64-1 1/4-3D-CA	7/8~57/64	11/4	42	84	60	22,4	
ED61/64-31/32-1 1/4-3D-CA	29/32~59/64	11/4	42	88	60	23,6	
ED63/64-1-11/4-3D-CA	61/64~1/32	11/4	42	91	60	24,4	

# RAPID DRILL

## RAPID DRILL

**ED...5D-CA Matkaplar**  
**ED...5D-CA Toolholders**

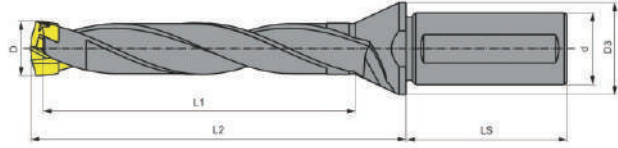

Ürün Kodu Order No	Uygulanabilir Kesim Kafa Çapı Applicable Cutting Head Dia	Boyutlar Dimensions(mm)					Anahtar Wrench
		d	D3	L1	Ls	D	
ED080/089-12-5D-CA	8,0~8,9	12	16	50	45	7,8	8-11,9
ED090/099-12-5D-CA	9,0~9,9	12	16	55	45	8,8	
ED100/109-16-5D-CA	10,0~10,9	16	20	60	48	9,8	
ED110/119-16-5D-CA	11,0~11,9	16	20	66	48	10,8	
ED120/129-16-5D-CA	12,0~12,9	16	20	71	48	11,8	12-16,9
ED130/139-16-5D-CA	13,0~13,9	16	20	77	48	12,8	
ED140/149-16-5D-CA	14,0~14,9	16	20	82	48	11,8	
ED150/159-20-5D-CA	15,0~15,9	20	23	88	50	14,8	
ED160/169-20-5D-CA	16,0~16,9	20	25	93	50	15,8	17-20,9
ED170/179-20-5D-CA	17,0~17,0	20	25	99	50	16,8	
ED180/189-25-5D-CA	18,0~18,9	25	32	104	56	17,8	
ED190/199-25-5D-CA	19,0~19,9	25	32	110	56	18,8	
ED200/209-25-5D-CA	20,0~20,9	25	32	115	56	19,8	21-26
ED210/219-25-5D-CA	21,0~21,9	25	32	121	56	20,8	
ED220/229-25-5D-CA	22,0~22,9	25	32	126	56	21,8	
ED230/239-32-5D-CA	23,0~23,9	32	42	132	60	22,8	
ED240/249-32-5D-CA	24,0~24,9	32	42	137	60	21,8	
ED250/260-32-5D-CA	25,0~26,0	32	42	143	60	24,8	
inch	inch	inch	mm	mm	mm	mm	
ED6/1611/321/2-5D-CA	5/16~11/32	1/2	16	50	45	7,5	8,11,2009
ED25/64-25/64M/2-5D-CA	23/64~25/64	1/2	16	55	45	8,8	
ED13/32-27/64-5/8-5D-CA	13/32~27/64	5/8	20	60	48	9,9	
ED7/1615/325/8-5D-CA	7/16~15/32	5/8	20	66	48	10,7	
ED3/641/21/8-5D-CA	31/64~1/2	5/8	20	71	48	11,9	12-16,9
ED33/64-35/64-1/2-5D-CA	33/64~35/64	5/8	20	77	48	12,6	
ED9/16-37/64-1/2-5D-CA	9/16~37/64	5/8	25	82	48	13,8	
ED19/32-5/8-3/4-5D-CA	19/32~5/8	3/4	25	88	50	14,5	
ED41/64-21/32-3/4-5D-CA	41/64~21/32	3/4	25	93	50	15,6	17-20,9
ED43/64-43/64-3/4-5D-CA	43/64~45/64	3/4	25	99	50	16,7	
ED23/32-47/64-1-5D-CA	23/32~47/64	1	32	104	56	17,6	
ED3/8-25/32-1-5D-CA	3/8~25/32	1	32	110	56	18,4	
ED31/64-13/16-1-5D-CA	51/64~13/16	1	32	115	56	19,6	21-26
EDS3/64-35/64-1-5D-CA	53/64~55/64	1	32	121	56	20,4	
ED7/8-57/64-1-5D-CA	7/8~57/64	1	32	126	56	21,6	
ED29/32-59/64-1 1/4-5D-CA	29/32~59/64	1 1/4	42	132	60	22,4	
ED61/64-31/32-1 1/4-5D-CA	61/64~1/32	1 1/4	42	137	60	23,6	
ED63/641-11/4-5D-CA	63/64~1	1 1/4	42	143	60	24,4	

# RAPID DRILL

## RAPID DRILL

**ED...8D-CA Matkaplar**  
**ED...8D-CA Toolholders**

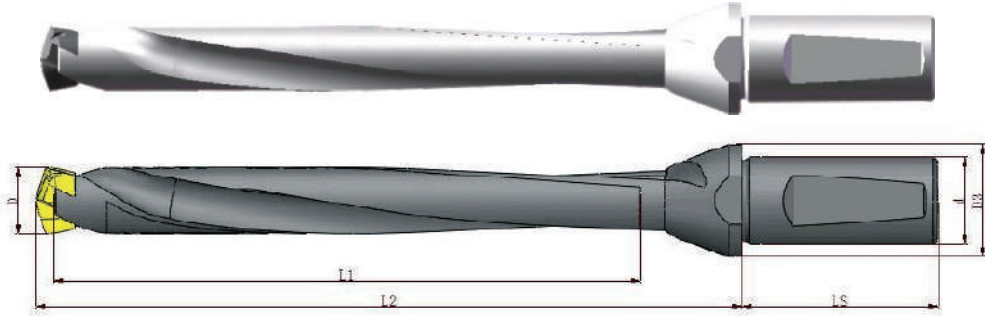

Ürün Kodu Order No	Uygulanabilir Kesim Kafa Çapı Applicable Cutting Head Dia	Boyutlar Dimensions(mm)					Anahtar Wrench
		d	D3	L1	Ls	D	
ED080/089-12-8D-CA	8,0~8,9	12	16	76	45	7,6	8-11,9
ED090/099-12-8D-CA	9,0~9,9	12	16	85	45	8,6	
ED100/109-16-8D-CA	10,0~10,9	16	20	93	48	9,6	
ED110/119-16-8D-CA	11,0~11,9	16	20	102	48	10,6	12-16,9
ED120/129-16-8D-CA	12,0~12,9	16	20	110	48	11,6	
ED130/139-16-8D-CA	13,0~13,9	16	20	119	48	12,6	
ED140/149-16-8D-CA	14,0~14,9	16	20	127	48	13,6	
ED150/159-20-8D-CA	15,0~15,9	20	25	136	50	14,6	
ED160/169-20-8D-CA	16,0~16,9	20	25	144	50	11,6	7-20,9
ED170/179-20-8D-CA	17,0~17,0	20	25	153	50	16,6	
ED180/189-25-8D-CA	18,0~18,9	25	32	161	56	11,6	
ED190/199-25-8D-CA	19,0~19,9	25	32	170	56	18,6	
ED200/209-25-8D-CA	20,0~20,9	25	32	178	56	19,6	
ED210/219-25-8D-CA	21,0~21,9	25	32	187	56	20,6	21 -26
ED220/229-25-8D-CA	22,0~22,9	25	32	195	56	21,6	
ED230/239-32-8D-CA	23,0~23,9	32	42	204	60	22,6	
ED240/249-32-8D-CA	24,0~24,9	32	42	212	60	21,6	
ED250/260-32-8D-CA	25,0~26,0	32	42	221	60	24,6	
inch	inch	inch	mm	mm	mm	mm	
ED6/1611/321/2-8D-CA	5/16~11/32	1/2	16	76	45	7,5	8-11,9
ED25/64-25/64M/2-8D-CA	23/64~25/64	1/2	16	85	45	8,8	
ED13/32-27/64-5/8-8D-CA	13/32~27/64	5/8	20	93	48	9,9	
ED7/1615/325/8-8D-CA	7/16~15/32	3/8	20	102	48	10,7	12-16,9
ED3/641/21/8-8D-CA	31/64~1/2	5/8	20	110	48	11,9	
ED33/64-35/64-1/2-8D-CA	33/64~35/64	5/8	20	119	48	12,6	
ED9/16-37/64-1/2-8D-CA	9/16~37/64	5/8	2J	127	48	13,8	
ED19/32-5/8-3/4-8D-CA	19/32~5/8	3/4	25	136	50	14,5	
ED41/64-21/32-3/4-8D-CA	41/64~21/32	3/4	25	144	50	15,6	17-20,9
ED43/64-43/64-3/4-8D-CA	43/64~45/64	3/4	25	153	50	16,7	
ED23/32-47/64-1-8D-CA	23/32~47/64	1	32	161	56	17,6	
ED3/8-25/32-1-8D-CA	3/8~25/32	1	32	170	56	18,4	
ED31/64-13/16-1-8D-CA	51/64~13/16	1	32	178	56	19,6	
EDS3/64-35/64-1-8D-CA	53/64~55/64	1	32	187	56	20,4	21-26
ED7/8-57/64-1-8D-CA	7/8~57/64	1	32	195	56	21,6	
ED29/32-59/64-1 1/4-8D-CA	29/32~59/64	11/4	42	204	60	22,4	
ED61/64-31/32-1 1/4-8D-CA	61/64~1/32	11/4	42	212	60	23,6	
ED63/641-11/4-8D-CA	63/64~1	11/4	42	221	60	24,4	

# RAPID DRILL

## RAPID DRILL

**ED...12D-CA Matkaplar**  
**ED...12D-CA Toolholders**

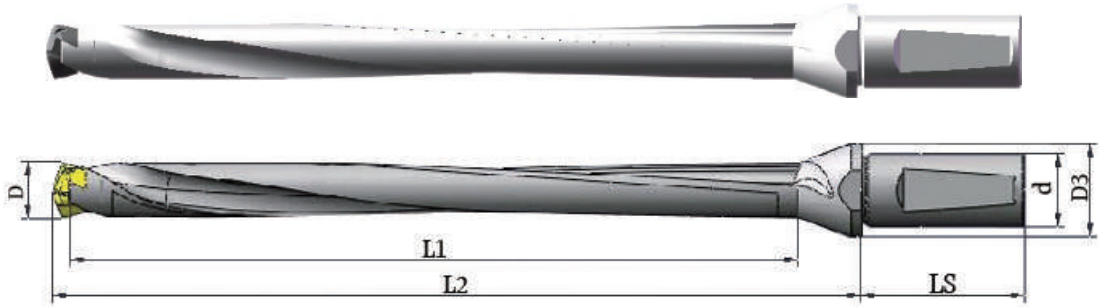

Ürün Kodu Order No	Uygulanabilir Kesim Kafa Çapı Applicable Cutting Head Dia	Boyutlar Dimensions(mm)					Anahtar Wrench
		d	D3	L1	Ls	D	
ED120/129-16-12D-CA	12,0~12,9	16	20	162	48	11,6	12-16,9
ED130/139-16-12D-CA	110~13,9	16	20	175	48	12,6	
ED140/149-16-12D-CA	14,0~14,9	16	20	187	48	13,6	
ED160/159-20-12D-CA	15,0~15,9	20	20	200	50	14,6	
ED160/169-20-12D-CA	16,0~16,9	20	20	212	50	15,6	
ED170/179-20-12D-CA	17,0~17,9	20	20	225	50	16,6	17-20,9
ED180/189-23-12D-CA	18,0~18,9	25	32	237	56	17,6	
ED190/199-25-12D-CA	19,0~19,9	25	32	250	56	18,6	
ED200/209-25-12D-CA	20,0~20,9	25	32	262	56	19,6	
ED210/219-25-12D-CA	21,0~21,9	25	32	275	56	20,6	
ED220/229-25-12D-CA	22,0~22,9	25	32	287	56	21,6	21-26
ED230/239-32-12D-CA	23,0~23,9	32	42	300	60	22,6	
ED240/249-32-12D-CA	24,0~24,9	32	42	313	60	23,6	
ED260/260-32-12D-CA	25,0~26,0	32	42	325	60	24,6	
inch	inch	inch	mm	mm	mm	mm	
ED31/64-1/2-5/8-12D-CA	31/64~1/2	5/8	20	162	48	11,9	12-16,9
ED33/64-35/64-1/2-12D-CA	33/64~35/64	5/8	20	175	48	12,6	
ED9/16-37/64-1/2-12D-CA	9/16~37/64	5/8	25	187	48	13,8	
ED19/32-5/8-3/4-12D-CA	19/32~5/8	3/4	25	200	50	14,5	
ED41/64-21/32-3/4-12D-CA	41/64~21/32	3/4	25	212	50	15,6	
ED43/64-45/64-3/4-12D-CA	43/64~45/64	3/4	25	225	50	16,7	17-20,9
ED23/32-47/64-1-12D-CA	23/32~47/64	1	32	237	56	17,6	
ED51/64-13/16-1-12D-CA	51/64~13/16	1	32	262	56	19,6	
EDS3/64-55/64-1-12D-CA	53/64~55/64	1	32	275	56	20,4	
EDS7/64-57/64-1-12D-CA	7/8~57/64	1	32	287	56	21,6	
ED29/32-59/64-11/4-12D-CA	29/32~59/64	11/4	42	300	60	22,4	21-26
ED61/64-31/32-11/4-12D-CA	61/64-1/32	11/4	42	313	60	23,6	



ED

1

3300

2

32

3

8D

4

D16

5

W08

6

<p>1 ED 3300 32 8D D16 W08</p> <p>ED: E-DRILL</p>	<p>2 ED 3300 32 8D D16 W08</p> <p>Kesme Başlığı Çapı Cutting Drill Dia. 28mm-42mm</p>	<p>3 ED 3300 32 8D D16 W08</p> <p>Şaft Çapı Shank Dia. 32,0mm</p>
<p>4 ED 3300 32 8D D16 W08</p> <p>Delme Derinliği 3xD Drill Depth 3xD</p> <p>Delme Derinliği 5xD Drill Depth 5xD</p> <p>Delme Derinliği 6xD Drill Depth 6xD</p> <p>Delme Derinliği 7xD Drill Depth 7xD</p> <p>Delme Derinliği 8xD Drill Depth 8xD</p> <p>Delme Derinliği 10xD Drill Depth 10xD</p>	<p>5 ED 3300 32 8D D16 W08</p> <p>Merkez Matkap Kafası Çapı 16mm Center Drill Head Dia. 16mm</p>	<p>6 ED 3300 32 8D D16 W08</p> <p>Kesici Uç Geniřlięi 8mm Side Insert Length 8mm</p>



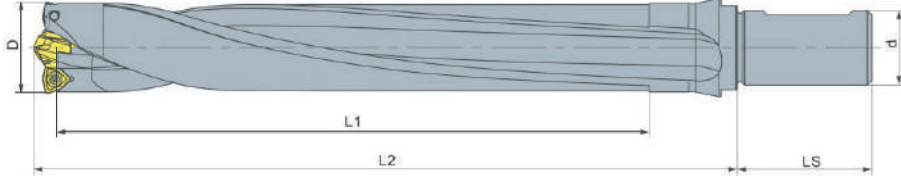

Ürün Kodu Order No	Merkez Matkap Başlığı Çapı Center Drill Head Dia	Yan Uç Side Inserts	Boyutlar Dimensions(mm)					Yedek Parça Spare Parts		
			d	L1	L2	Ls	D			
ED2800-32-3D-D14/A04	MD-140-EA	AOMT040308	32	84	118	60	28	Key14-16	M2.5X8	T9
ED2858-32-3D-D15/A04	MD-150-EA	AOMT040308	32	86	120	60	28,58			
ED2900-32-3D-D16/A04	MD-160-EA	AOMT040308	32	87	121	60	29			
ED2936-32-3D-D16/A04	MD-160-EA	AOMT040108	32	89	123	60	29,36			
ED3000-32-3D-D16/A04	MD-160-EA	AOMT040308	32	90	125	60	30			
ED3018-32-3D-D17/A04	MD-170-EA	AOMT040308	32	91	126	60	30,18			
ED3096-32-3D-D17/A04	MD-170-EA	AOMT040308	32	93	128	60	30,96	Key17-20		
ED3100-32-3D-D17/A04	MD-170-EA	AOMT040308	32	94	129	60	31			
ED3175-32-3D-D15/W08	MD-150-EA	WOMT080308-...-D33	32	96	133	60	31,75	Key14-16	M3X8	T10
ED3200-32-3D-D15/W08	MD-170-EA	WOMT080308-...-D33	32	97	134	60	32			
ED3300-32-3D-D16/W08	MD-160-EA	WOMT080308-...-D33	32	99	136	60	33			
ED3320-32-3D-D16/W08	MD-160-EA	WOMT080308-...-D33	32	100	137	60	33,2			
ED3335-32-3D-D16/W08	MD-160-EA	WOMT080308-...-D33	32	101	138	60	33,35			
ED3400-32-3D-D16/W08	MD-160-EA	WOMT080308-...-D33	32	102	139	60	34			
ED3493-32-3D-D18/W08	MD-180-EA	WOMT080308-...-D33	32	105	142	60	34,93	Key17-20		
ED3500-32-3D-D18/W08	MD-180-EA	WOMT080308-...-D33	32	106	144	60	35			
ED3600-32-3D-D18/W08	MD-180-EA	WOMT080308-...-D33	32	108	146	60	36			
ED3653-32-3D-D19/W08	MD-190-EA	WOMT080308-...-D33	32	110	148	60	36,53			
ED3700-32-3D-D16/W10	MD-160-EA	WOMT100308-...-D39	3	111	149	60	37			
ED3750-32-3D-D16/W10	MD-160-EA	WOMT100308-...-D39	32	113	151	60	37,5			
ED3800-32-3D-D16/W10	MD-160-EA	WOMT100308-...-D39	32	114	154	60	38	Key14-16		
ED3810-32-3D-D16/W10	MD-160-EA	WOMT100308-...-D39	32	115	155	60	38,1			
ED3900-32-3D-D18/W10	MD-180-EA	WOMT100308-...-D39	32	117	157	60	39			
ED3920-32-3D-D18/W10	MD-180-EA	WOMT100308-...-D39	32	118	158	60	39,2			
ED3970-32-3D-D18/W10	MD-180-EA	WOMT100308-...-D39	3	120	160	60	39,7			
ED4000-32-3D-D18/W10	MD-180-EA	WOMT100308-...-D39	50	121	164	70	40			
ED4100-32-3D-D19/W10	MD-190-EA	WOMT100308-...-D39	50	123	166	70	41	Key17-20		
ED4128-32-3D-D19/W10	MD-190-EA	WOMT100308-...-D39	50	124	167	70	41,28			
ED4200-50-3D-D19/W10	MD-190-EA	WOMT120408-...-D42	fi	126	170	70	42			
ED4300-50-3D-D16/W12	MD-160-EA	WOMT120408-...-D42	50	129	173	70	43			
ED4400-50-3D-D18/W12	MD-180-EA	WOMT120408-...-D42	50	132	176	70	44			
ED4445-50-3D-D18/W12	MD-180-EA	WOMT120408-...-D42	50	134	178	70	44,45			
ED4500-30-3D-D18/W12	MD-180-EA	WOMT120408-...-D42	50	135	179	70	45	Key17-20	M4X10	TU
ED4600-50-3D-D19/W12	MD-190-EA	WOMT120408-...-D42	30	138	182	70	46			
ED4700-50-3D-D20/W12	MD-200-EA	WOMT120408-...-D42	50	141	185	70	47			
ED4763-30-3D-D21/W12	MD-210-EA	WOMT120408-...-D42	50	143	187	70	47,63			
ED4800-50-3D-D21/W12	MD-210-EA	WOMT120408-...-D42	50	144	189	70	48			
ED4900-50-3D-D227/W12	MD-220-EA	WOMT120408-...-D42	50	147	192	70	49			
ED5000-50-3D-D23/W12	MD-230-EA	WOMT120408-...-D42	TO	150	195	70	50	Key21 -28		
ED5080-50-3D-D24/W12	MD-240-EA	WOMT120408-...-D42	50	153	198	70	50,8			
ED5100-50-3D-D24/W12	MD-240-EA	WOMT120408-...-D42	50	154	199	70	51			
ED5200-50-3D-D25/W12	MD-250-EA	WOMT120408-...-D42	50	156	201	70	52			
ED3300-30-3D-D26/W12	MD-260-EA	WOMT120408-...-D42	50	159	204	70	53			
ED5398-50-3D-D27/W12	MD-270-EA	WOMT120408-...-D42	50	162	207	70	53,98			
ED5400-50-3D-D27/W12	MD-270-EA	WOMT120408-...-D42	50	163	208	70	54			
ED5500-50-3D-D28/W12	MD-280-EA	WOMT120408-...-D42	50	165	210	70	55			

Ürün Kodu Order No	Merkez Matkap Başlığı Çapı Center Drill Head Dia	Yan Uç Side Inserts x2	Boyutlar Dimensions(mm)					Yedek Parça Spare Parts		
			d	L1	L2	Ls	D			
ED5600-50-3D-D20/W15	MD-200-EA	WOMT150308-...-DSC	50	168	213	70	56	Key17-20	M5X10	T20
ED5700-50-3D-D21/W15	MD-210-EA	WOMT150308-...-DBC	50	171	216	70	57			
ED8000-50-3D-D22/W15	MD-220-EA	WOMT130708-...-D3S	50	174	219	70	58			
ED5900-50-3D-D23/W15	MD-230-EA	WOMT150308-...-DSC	50	177	222	70	59			
ED6000-50-3D-D24/W15	MD-240-EA	WOMT150308-...-DBC	50	180	225	70	60			
ED6100-50-3D-D25/W15	MD-250-EA	WOMT130308-...-D33	50	183	228	70	61			
ED6200-50-3D-D26/W15	MD-260-EA	WOMT1S0708-...-DBC	50	186	231	70	62			
ED6300-50-3D-D27/W15	MD-270-EA	WOMT150708-...-DSC	50	189	234	70	63			
ED6400-50-3D-D28/W15	MD-280-EA	WOMT130308-...-D33	50	192	237	70	64			
ED6500-50-3D-D29/W15	MD-290-EA	WOMT170708-...-D3S	50	195	240	70	65			
ED6600-50-3D-D30/W15	MD-300-EA	WOMT150308-...-DSC	50	198	243	70	66	Key29-34		
ED6670-50-3D-D31/W15	MD-310-EA	WOMT150308-...-DBC	50	201	246	70	67			
ED6800-50-3D-D31/W15	MD-320-EA	WOMT130708-...-D3S	50	204	249	70	68			
ED6900-50-3D-D33/W15	MD-330-EA	WOMT150308-...-DSC	50	207	252	70	69			
ED7000-50-3D-D34/W15	MD-340-EA	WOMT150308-...-DBC	50	210	255	70	70			

# RAPID DRILL

# RAPID DRILL

## ED...5D Yekpare Takım Tutucular ED...5D Solid Toolholders

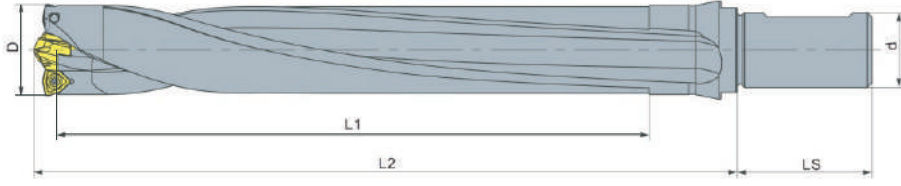

Ürün Kodu Order No	Merkez Matkap Başlığı Çapı Center Drill Head Dia	Yan Uç Side Inserts x2	Boyutlar Dimensions(mm)					Yedek Parça Spare Parts		
			d	L1	L2	Ls	D			
ED2800-32-5D-D14/A04	MD-140-EA	AOMT040308	32	140	174	60	28	Key14-16	M2.5X8	T9
ED2858-32-5D-D15/A04	MD-150-EA	AOMT040308	32	143	177	60	29			
ED2900-32-5D-D16/A04	MD-160-EA	AOMT040308	32	145	179	60	29			
ED2936-32-5D-D16/A04	MD-160-EA	AOMT040108	32	147	181	60	29,36			
ED3000-32-5D-D16/A04	MD-160-EA	AOMT040308	32	150	186	60	30	Key17-20		
ED3018-32-5D-D17/A04	MD-170-EA	AOMT040308	32	151	186	60	30,18			
ED3096-32-5D-D17/A04	MD-170-EA	AOMT040308	32	155	190	60	30,96	Key14-16	M3X8	T10
ED3100-32-5D-D17/A04	MD-170-EA	AOMT040308	32	156	191	60	31			
ED3175-32-5D-D15/W08	MD-150-EA	WOMT080308-...-D33	32	159	196	60	31,75	Key17-20		
ED3200-32-3D-D15/W08	MD-150-EA	WOMT080308-...-D33	32	160	197	60	32			
ED3300-32-5D-D16/W08	MD-160-EA	WOMT080308-...-D33	32	165	202	60	33			
ED3320-32-5D-D16/W08	MD-160-EA	WOMT080308-...-D33	32	166	203	60	33,2			
ED3335-32-5D-D16/W08	MD-160-EA	WOMT080308-...-D33	32	167	204	60	33,35	Key14-16	M3X8	T10
ED3400-32-5D-D16/W08	MD-160-EA	WOMT080308-...-D33	32	170	207	60	34			
ED3493-32-5D-D18/W08	MD-180-EA	WOMT080308-...-D33	32	175	212	60	34,93	Key17-20		
ED3500-32-5D-D18/W08	MD-180-EA	WOMT080308-...-D33	32	176	214	60	35			
ED3600-32-5D-D18/W08	MD-180-EA	WOMT080308-...-D33	32	180	218	60	36	Key14-16		
ED3653-32-5D-D19/W08	MD-190-EA	WOMT080308-...-D33	32	183	221	60	36,53			
ED3700-32-5D-D16/W10	MD-160-EA	WOMT100308-...-D39	32	185	223	60	37			
ED3750-32-3D-D16/W10	MD-160-EA	WOMT100308-...-D39	32	188	226	60	37,5			
ED3800-32-5D-D16/W10	MD-160-EA	WOMT100308-...-D39	32	190	230	60	38	Key17-20		
ED3810-32-5D-D16/W10	MD-160-EA	WOMT100308-...-D39	32	191	231	60	38			
ED3900-32-5D-D18/W10	MD-180-EA	WOMT100308-...-D39	32	195	235	60	39	Key14-16		
ED3920-32-5D-D18/W10	MD-180-EA	WOMT100308-...-D39	32	196	236	60	39,2			
ED3970-32-5D-D18/W10	MD-180-EA	WOMT100308-...-D39	32	199	239	60	39,7			
ED4000-32-5D-D18/W10	MD-180-EA	WOMT100308-...-D39	50	200	243	70	40			
ED4100-32-5D-D19/W10	MD-190-EA	WOMT100308-...-D39	50	205	248	70	41	Key17-20		
ED4128-32-5D-D19/W10	MD-190-EA	WOMT100308-...-D39	50	207	250	70	41,28			
ED4200-50-5D-D19/W10	MD-190-EA	WOMT120408-...-D42	50	210	254	70	42	Key14-16		
ED4300-50-5D-D16/W12	MD-160-EA	WOMT120408-...-D42	50	213	259	70	43			
ED4400-50-5D-D18/W12	MD-180-EA	WOMT120408-...-D42	50	220	264	70	44			
ED4445-50-5D-D18/W12	MD-180-EA	WOMT120408-...-D42	50	223	267	70	44,45			
ED4500-30-5D-D18/W12	MD-180-EA	WOMT120408-...-D42	50	225	269	70	45	Key17-20	M4X10	T15
ED4600-50-5D-D19/W12	MD-190-EA	WOMT120408-...-D42	50	230	274	70	46			
ED4700-50-5D-D20/W12	MD-200-EA	WOMT120408-...-D42	50	235	279	70	47	Key21-28		
ED4763-30-5D-D21/W12	MD-210-EA	WOMT120408-...-D42	50	239	183	70	47,63			
ED4800-50-5D-D21/W12	MD-210-EA	WOMT120408-...-D42	50	240	285	70	48			
ED4900-50-5D-D22/W12	MD-220-EA	WOMT120408-...-D42	50	245	290	70	49			
ED5000-50-5D-D23/W12	MD-230-EA	WOMT120408-...-D42	50	250	295	70	50	Key17-20		
ED5080-50-3D-D24/W12	MD-240-EA	WOMT120408-...-D42	50	254	299	70	50,8			
ED5100-50-5D-D24/W12	MD-240-EA	WOMT120408-...-D42	50	255	300	70	51			
ED5200-50-5D-D25/W12	MD-250-EA	WOMT120408-...-D42	50	260	305	70	52			
ED3300-30-5D-D26/W12	MD-260-EA	WOMT120408-...-D42	50	265	310	70	53	Key17-20		
ED5398-50-5D-D27/W12	MD-270-EA	WOMT120408-...-D42	50	270	315	70	53,98			
ED5400-50-5D-D27/W12	MD-270-EA	WOMT120408-...-D42	50	271	316	70	54			
ED3500-30-5D-D28/W12	MD-280-EA	WOMT120408-...-D42	50	275	320	70	55			

Ürün Kodu Order No	Merkez Matkap Başlığı Çapı Center Drill Head Dia	Yan Uç Side Inserts x2	Boyutlar					Yedek Parça Spare Parts		
			d	L1	L2	Ls	D			
ED5600-50-5D-D20/W15	MD-200-EA	WOMT150308-...-D55	50	280	325	70	56	Key17-20		
ED3700-50-3D-D21/W13	MD-210-EA	WOMT150308-...-D55	50	285	330	70	57			
ED5800-50-5D-D22/W15	MD-220-EA	WOMT150308-...-D55	50	290	335	70	58			
ED5900-50-5D-D23/W15	MD-230-EA	WOMT150308-...-D55	50	295	340	70	59			
ED6000-50-3D-D24/W15	MD-240-EA	WOMT150308-...-D55	50	300	345	70	60	Key21-28		
ED6100-50-3D-D25/W15	MD-250-EA	WOMT150308-...-D55	50	305	350	70	61			
ED6200-50-5D-D26/W15	MD-260-EA	WOMT150308-...-D55	50	310	355	70	62			
ED6300-50-5D-D27/W15	MD-270-EA	WOMT150308-...-D55	50	315	360	70	63			
ED6400-50-3D-D28/W15	MD-280-EA	WOMT150308-...-D55	50	320	365	70	64	Key29-34	M5X10	T20
ED6500-50-5D-D29/W15	MD-290-EA	WOMT150308-...-D55	50	325	370	70	65			
ED6600-50-5D-D30/W15	MD-300-EA	WOMT150308-...-D55	50	330	375	70	66			
ED6700-50-3D-D31/W15	MD-310-EA	WOMT150308-...-D55	50	335	380	70	67			
ED6800-50-5D-D32/W15	MD-320-EA	WOMT150308-...-D55	50	340	385	70	68	Key21-28		
ED6900-50-5D-D33/W15	MD-330-EA	WOMT150308-...-D55	50	345	390	70	69			
ED7000-50-3D-D34/W15	MD-340-EA	WOMT150308-...-D55	50	350	395	70	70			

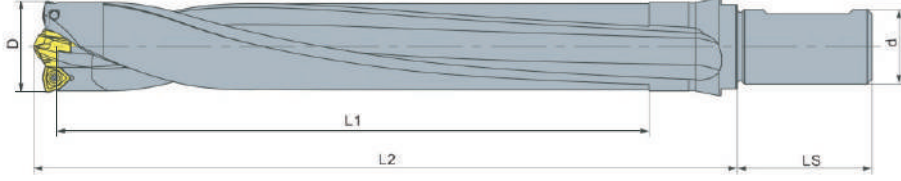

Ürün Kodu Order No	Merkez Matkap Başlığı Çapı Center Drill Head Dia	Yan Uç Side Inserts x2	Boyutlar Dimensions(mm)					Yedek Parça Spare Parts		
			d	L1	L2	Ls	D			
ED2800-32-6D-D14/A04	MD-140-EA	AOMT040308	32	168	202	60	28	Key14-16	M2,5X8	T9
ED2858-32-6D-D15/A04	MD-150-EA	AOMT040308	32	172	206	60	28,58			
ED2900-32-6D-D16/A04	MD-160-EA	AOMT040308	32	174	208	60	29			
ED2936-32-6D-D16/A04	MD-160-EA	AOMT040108	32	177	211	60	29,4			
ED3000-32-6D-D16/A04	MD-160-EA	AOMT040308	32	180	215	60	30	Key17-20		
ED3018-32-6D-D17/A04	MD-170-EA	AOMT040308	32	182	217	60	30,18			
ED3096-32-6D-D17/A04	MD-170-EA	AOMT040308	32	186	221	60	30,96	Key14-16		
ED3100-32-6D-D17/A04	MD-170-EA	AOMT040308	32	187	222	60	31			
ED3175-32-6D-D15/W08	MD-150-EA	WOMT080308-...-D33	32	191	228	60	31,75	Key14-16	M3X8	T10
ED3200-32-6D-D15/W08	MD-170-EA	WOMT080308-...-D33	32	192	229	60	32			
ED3300-32-6D-D16/W08	MD-160-EA	WOMT080308-...-D33	32	198	235	60	33			
ED3320-32-6D-D16/W08	MD-160-EA	WOMT080308-...-D33	32	200	237	60	33,2			
ED3335-32-6D-D16/W08	MD-160-EA	WOMT080308-...-D33	32	201	238	60	33,4	Key17-20		
ED3400-32-6D-D16/W08	MD-160-EA	WOMT080308-...-D33	32	204	241	60	34			
ED3493-32-6D-D18/W08	MD-180-EA	WOMT080308-...-D33	32	210	247	60	34,93	Key14-16		
ED3500-32-6D-D18/W08	MD-180-EA	WOMT080308-...-D33	32	211	249	60	35			
ED3600-32-6D-D18/W08	MD-180-EA	WOMT080308-...-D33	32	216	254	60	36	Key17-20		
ED3653-32-6D-D19/W08	MD-190-EA	WOMT080308-...-D33	32	220	258	60	36,53			
ED3700-32-6D-D16/W10	MD-160-EA	WOMT100308-...-D39	32	222	260	60	37	Key14-16		
ED3750-32-6D-D16/W10	MD-160-EA	WOMT100308-...-D39	32	225	263	60	37,5			
ED3800-32-6D-D16/W10	MD-160-EA	WOMT100308-...-D39	32	228	268	60	38	Key17-20		
ED3810-32-6D-D16/W10	MD-160-EA	WOMT100308-...-D39	32	229	269	60	38,			
ED3900-32-6D-D18/W10	MD-180-EA	WOMT100308-...-D39	32	234	274	60	39	Key14-16		
ED3920-32-6D-D18/W10	MD-180-EA	WOMT100308-...-D39	32	236	276	60	39,2			
ED3970-32-6D-D18/W10	MD-180-EA	WOMT100308-...-D39	32	239	279	70	39,7	Key17-20		
ED4000-32-6D-D18/W10	MD-180-EA	WOMT100308-...-D39	50	240	283	70	40			
ED4100-32-6D-D19/W10	MD-190-EA	WOMT100308-...-D39	50	246	289	70	41	Key14-16	M4X10	T15
ED4128-32-6D-D19/W10	MD-190-EA	WOMT100308-...-D39	50	248	291	70	41,28			
ED4200-50-6D-D19/W10	MD-190-EA	WOMT120408-...-D42	50	252	296	70	42	Key17-20		
ED4300-S0-6D-D16/W12	MD-160-EA	WOMT120408-...-D42	50	258	302	70	43			
ED4400-50-6D-D18/W12	MD-180-EA	WOMT120408-...-D42	50	264	308	70	44	Key14-16		
ED4445-50-6D-D18/W12	MD-180-EA	WOMT120408-...-D42	50	267	311	70	44,45			
ED4S00-30-6D-D18/W12	MD-180-EA	WOMT120408-...-D42	50	270	314	70	45	Key17-20		
ED4600-50-6D-D19/W12	MD-190-EA	WOMT120408-...-D42	50	276	320	70	46			
ED4700-50-6D-D20/W12	MD-200-EA	WOMT120408-...-D42	50	282	326	70	47	Key14-16		
ED4763-30-6D-D21/W12	MD-210-EA	WOMT120408-...-D42	50	286	330	70	47,63			
ED4800-50-6D-D21/W12	MD-210-EA	WOMT120408-...-D42	50	288	333	70	48	Key17-20		
ED4900-50-6D-D22/W12	MD-220-EA	WOMT120408-...-D42	50	294	339	70	49			
ED5000-50-6D-D23/W12	MD-230-EA	WOMT120408-...-D42	50	300	345	70	50	Key14-16		
ED5080-S0-6D-D24/W12	MD-240-EA	WOMT120408-...-D42	50	305	350	70	50,8			
ED5100-50-6D-D24/W12	MD-240-EA	WOMT120408-...-D42	50	306	351	70	51	Key17-20		
ED5200-50-6D-D25/W12	MD-250-EA	WOMT120408-...-D42	50	312	357	70	52			
ED3300-30-6D-D26/W12	MD-260-EA	WOMT120408-...-D42	50	318	363	70	53	Key14-16		
ED5398-50-6D-D27/W12	MD-270-EA	WOMT120408-...-D42	50	324	369	70	53,98			
ED5400-50-6D-D27/W12	MD-270-EA	WOMT120408-...-D42	50	325	370	70	54	Key17-20		
ED3S00-30-6D-D28/W12	MD-280-EA	WOMT120408-...-D42	50	330	375	70	55			

Ürün Kodu Order No	Merkez Matkap Başlığı Çapı Center Drill Head Dia	Yan Uç Side Inserts x2	Boyutlar Dimensions(mm)					Yedek Parça Spare Parts		
			d	L1	L2	Ls	D			
ED5600-50-5D-D20/W15	MD-200-EA	WOMT150308-...-D55	50	336	381	70	56	Key17-20	M5X10	T20
ED3700-50-3D-D21/W13	MD-210-EA	WOMT150308-...-D55	50	342	387	70	57			
ED5800-50-5D-D22/W15	MD-220-EA	WOMT150308-...-D55	50	348	393	70	58			
ED5900-50-5D-D22/W15	MD-230-EA	WOMT150308-...-D55	50	354	399	70	59			
ED6000-50-3D-D24/W15	MD-240-EA	WOMT150308-...-D55	50	360	405	70	60	Key21-28		
ED6100-50-3D-D25/W15	MD-250-EA	WOMT150308-...-D55	50	366	411	70	61			
ED6200-50-5D-D26/W15	MD-260-EA	WOMT150308-...-D55	50	372	417	70	62	Key17-20		
ED6300-50-5D-D27/W15	MD-270-EA	WOMT150308-...-D55	50	378	423	70	63			
ED6400-50-3D-D28/W15	MD-280-EA	WOMT150308-...-D55	50	384	429	70	64	Key29-34		
ED6500-50-5D-D29/W15	MD-290-EA	WOMT150308-...-D55	50	390	435	70	65			
ED6600-50-5D-D30/W15	MD-300-EA	WOMT150308-...-D55	50	396	441	70	66	Key17-20		
ED6700-50-3D-D31/W15	MD-310-EA	WOMT150308-...-D55	50	402	447	70	67			
EDG800-50-5D-D32/W15	MD-320-EA	WOMT150308-...-D55	50	408	453	70	68	Key14-16		
ED6900-50-5D-D33/W15	MD-330-EA	WOMT150308-...-D55	50	414	459	70	69			
ED7000-50-3D-D34/W15	MD-340-EA	WOMT150308-...-D55	50	420	465	70	70			

# RAPID DRILL

# RAPID DRILL

## ED...7D Yekpare Takım Tutucular ED...7D Solid Toolholders

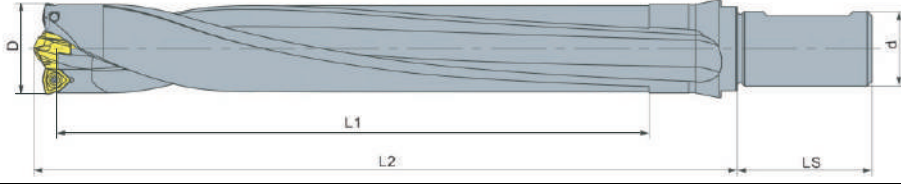

Ürün Kodu Order No	Merkez Matkap Başlığı Çapı Center Drill Head Dia	Yan Uç Side Inserts x2	Boyutlar Dimensions(mm)					Yedek Parça Spare Parts		
			d	L1	L2	Ls	D	Key	M	T
ED2800-32-7D-D14/A04	MD-140-EA	AOMT040308	32	196	230	60	28			
ED2858-32-7D-D15/A04	MD-150-EA	AOMT040308	32	201	235	60	28,58			
ED2900-32-7D-D16/A04	MD-160-EA	AOMT040308	32	203	237	60	29			
ED2936-32-7D-D16/A04	MD-160-EA	AOMT040108	32	206	240	60	29,36			
ED3000-32-7D-D16/A04	MD-160-EA	AOMT040308	32	210	245	60	30			
ED3018-32-7D-D17/A04	MD-170-EA	AOMT040308	32	212	247	60	30,18			
ED3096-32-7D-D17/A04	MD-170-EA	AOMT040308	32	217	252	60	30,96	Key1 7-20		
ED3100-32-7D-D17/A04	MD-170-EA	AOMT040308	32	218	253	60	31			
ED3175-32-7D-D15/W08	MD-150-EA	WOMT080308-...-D33	32	223	260	60	35,75	Key14-16	M3X8	T10
ED3200-32-7D-D15/W08	MD-150-EA	WOMT080308-...-D33	32	224	261	60	32			
ED3300-32-7D-D16/W08	MD-160-EA	WOMT080308-...-D33	32	231	268	60	33			
ED3320-32-7D-D16/W08	MD-160-EA	WOMT080308-...-D33	32	233	270	60	33,2			
ED3335-32-7D-D16/W08	MD-160-EA	WOMT080308-...-D33	32	234	271	60	33,35			
ED3400-32-7D-D16/W08	MD-160-EA	WOMT080308-...-D33	32	238	275	60	34			
ED3493-32-7D-D18/W08	MD-180-EA	WOMT080308-...-D33	32	245	282	60	34,93	Key17-20		
ED3500-32-7D-D18/W08	MD-180-EA	WOMT080308-...-D33	32	246	284	60	35			
ED3600-32-7D-D18/W08	MD-180-EA	WOMT080308-...-D33	32	252	290	60	36			
ED3653-32-7D-D19/W08	MD-190-EA	WOMT080308-...-D33	32	256	294	60	36,53			
ED3700-32-7D-D16/W10	MD-160-EA	WOMT100308-...-D39	32	259	297	60	37	Key14-16		
ED3750-32-7D-D16/W10	MD-160-EA	WOMT100308-...-D39	32	263	301	60	37,5			
ED3800-32-7D-D16/W10	MD-160-EA	WOMT100308-...-D39	32	266	306	60	38			
ED3810-32-7D-D16/W10	MD-160-EA	WOMT100308-...-D39	32	267	307	60	38,1			
ED3900-32-7D-D18/W10	MD-180-EA	WOMT100308-...-D39	32	273	313	60	39			
ED3920-32-7D-D18/W10	MD-180-EA	WOMT100308-...-D39	32	275	315	60	39,2			
ED3970-32-7D-D18/W10	MD-180-EA	WOMT100308-...-D39	32	278	318	60	39,7	Key1 7-20		
ED4000-50-7D-D18/W10	MD-180-EA	WOMT100308-...-D39	50	280	323	60	40			
ED4100-50-7D-D19/W10	MD-190-EA	WOMT100308-...-D39	50	287	330	70	41			
ED4128-50-7D-D19/W10	MD-190-EA	WOMT100308-...-D39	50	289	332	70	41,28			
ED4200-50-7D-D19/W10	MD-190-EA	WOMT120408-...-D42	50	294	338	70	42			
ED4300-50-7D-D16/W12	MD-160-EA	WOMT120408-...-D42	50	301	345	70	43			
ED4400-50-7D-D18/W12	MD-180-EA	WOMT120408-...-D42	50	308	352	70	44			
ED4445-50-7D-D18/W12	MD-180-EA	WOMT120408-...-D42	50	312	356	70	44,45	Key17-20	M4X10	T15
ED4500-30-7D-D18/W12	MD-180-EA	WOMT120408-...-D42	50	315	359	70	45			
ED4600-50-7D-D19/W12	MD-190-EA	WOMT120408-...-D42	50	322	366	70	46			
ED4700-50-7D-D20/W12	MD-200-EA	WOMT120408-...-D42	50	329	373	70	47			
ED4763-30-7D-D21/W12	MD-210-EA	WOMT120408-...-D42	50	334	378	70	47,63			
ED4800-50-7D-D21/W12	MD-210-EA	WOMT120408-...-D42	50	336	381	70	48			
ED4900-50-7D-D22/W12	MD-220-EA	WOMT120408-...-D42	50	343	388	70	49	Key21-28		
ED5000-50-7D-D23/W12	MD-230-EA	WOMT120408-...-D42	50	350	395	70	50			
ED5080-50-7D-D24/W12	MD-240-EA	WOMT120408-...-D42	50	356	401	70	50,8			
ED5100-50-7D-D24/W12	MD-240-EA	WOMT120408-...-D42	50	357	402	70	51			
ED5200-50-7D-D25/W12	MD-250-EA	WOMT120408-...-D42	50	364	409	70	52			
ED5300-30-7D-D26/W12	MD-260-EA	WOMT120408-...-D42	50	371	416	70	53			
ED5398-50-7D-D27/W12	MD-270-EA	WOMT120408-...-D42	50	378	423	70	53,98			
ED5400-50-7D-D27/W12	MD-270-EA	WOMT120408-...-D42	50	379	424	70	54			
ED5500-30-7D-D28/W12	MD-280-EA	WOMT120408-...-D42	50	385	430	70	55			

Ürün Kodu Order No	Merkez Matkap Başlığı Çapı Center Drill Head Dia	Yan Uç Side Inserts x2	Boyutlar Dimensions(mm)					Yedek Parça Spare Parts		
			d	L1	L2	Ls	D	Key	M	T
ED5600-50-5D-D20/W15	MD-200-EA	WOMT150308-...-D55	50	392	437	70	56			
ED3700-50-3D-D21/W13	MD-210-EA	WOMT150308-...-D55	50	399	444	70	57			
ED5800-50-5D-D22/W15	MD-220-EA	WOMT150308-...-D55	50	406	451	70	58			
ED5900-50-5D-D22/W15	MD-230-EA	WOMT150308-...-D55	50	413	458	70	59			
ED6000-50-3D-D24/W15	MD-240-EA	WOMT150308-...-D55	50	420	465	70	60			
ED6100-50-3D-D25/W15	MD-250-EA	WOMT150308-...-D55	50	427	472	70	61			
ED6200-50-5D-D26/W15	MD-260-EA	WOMT150308-...-D55	50	434	479	70	62			
ED6300-50-5D-D27/W15	MD-270-EA	WOMT150308-...-D55	50	441	486	70	63			
ED6400-50-3D-D28/W15	MD-280-EA	WOMT150308-...-D55	50	448	493	70	64			
ED6500-50-5D-D29/W15	MD-290-EA	WOMT150308-...-D55	50	455	500	70	65			
ED6600-50-5D-D30/W15	MD-300-EA	WOMT150308-...-D55	50	462	507	70	66			
ED6700-50-5D-D31/W15	MD-310-EA	WOMT150308-...-D55	50	469	514	70	67			
EDG800-50-5D-D32/W15	MD-320-EA	WOMT150308-...-D55	50	476	521	70	68			
ED6900-50-5D-D33/W15	MD-330-EA	WOMT150308-...-D55	50	483	528	70	69			
ED7000-50-3D-D34/W15	MD-340-EA	WOMT150308-...-D55	50	490	535	70	70			



# RAPID DRILL

# RAPID DRILL

## ED...8D Yekpare Takım Tutucular ED...8D Solid Toolholders

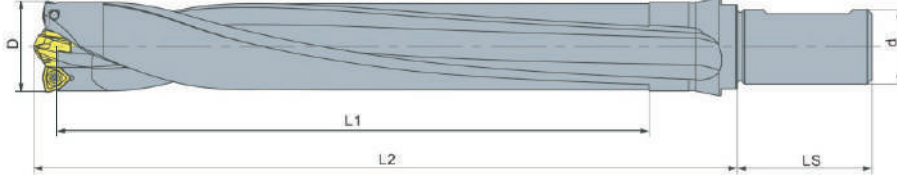

Ürün Kodu Order No	Merkez Matkap Başlığı Çapı Center Drill Head Dia	Yan Uç Side Inserts x2	Boyutlar Dimensions(mm)					Yedek Parça Spare Parts		
			d	L1	L2	Ls	D			
ED2800-32-8D-D14/A04	MD-140-EA	AOMT040308	32	224	258	60	28	Key14-16	M2,5X8	T9
ED2858-32-8D-D15/A04	MD-150-EA	AOMT040308	32	229	263	60	28,58			
ED2900-32-8D-D16/A04	MD-160-EA	AOMT040308	32	232	266	60	29	Key17-20		
ED2936-32-8D-D16/A04	MD-160-EA	AOMT040108	32	235	269	60	29,36			
ED3000-32-8D-D16/A04	MD-160-EA	AOMT040308	32	240	275	60	30	Key17-20		
ED3018-32-8D-D17/A04	MD-170-EA	AOMT040308	32	242	277	60	30,18			
ED3096-32-8D-D17/A04	MD-170-EA	AOMT040308	32	248	283	60	30,96	Key14-16		
ED3100-32-8D-D17/A04	MD-170-EA	AOMT040308	32	249	284	60	31			
ED3175-32-8D-D15/W08	MD-150-EA	WOMT080308-...-D33	32	254	291	60	31,75	Key14-16		
ED3200-32-8D-D15/W08	MD-150-EA	WOMT080308-...-D33	32	256	293	60	32			
ED3300-32-8D-D16/W08	MD-160-EA	WOMT080308-...-D33	32	264	301	60	33	Key17-20		
ED3320-32-8D-D16/W08	MD-160-EA	WOMT080308-...-D33	32	266	303	60	33,2			
ED3335-32-8D-D16/W08	MD-160-EA	WOMT080308-...-D33	32	267	304	60	33,35	Key14-16		
ED3400-32-8D-D16/W08	MD-160-EA	WOMT080308-...-D33	32	272	309	60	34			
ED3493-32-8D-D18/W08	MD-180-EA	WOMT080308-...-D33	32	280	317	60	34,93	Key17-20		
ED3500-32-8D-D18/W08	MD-180-EA	WOMT080308-...-D33	32	281	319	60	35			
ED3600-32-8D-D18/W08	MD-180-EA	WOMT080308-...-D33	32	288	326	60	36	Key14-16		
ED3653-32-8D-D19/W08	MD-190-EA	WOMT080308-...-D33	32	293	331	60	36,53			
ED3700-32-8D-D16/W10	MD-160-EA	WOMT100308-...-D39	32	296	334	60	37	Key17-20		
ED3750-32-8D-D16/W10	MD-160-EA	WOMT100308-...-D39	32	300	338	60	37,5			
ED3800-32-8D-D16/W10	MD-160-EA	WOMT100308-...-D39	32	304	344	60	38	Key14-16		
ED3810-32-8D-D16/W10	MD-160-EA	WOMT100308-...-D39	32	305	345	60	38,			
ED3900-32-8D-D18/W10	MD-180-EA	WOMT100308-...-D39	32	312	352	60	39	Key17-20		
ED3920-32-8D-D18/W10	MD-180-EA	WOMT100308-...-D39	32	314	354	60	39,2			
ED3970-32-8D-D18/W10	MD-180-EA	WOMT100308-...-D39	32	318	358	60	39,7	Key14-16		
ED4000-50-8D-D18/W10	MD-180-EA	WOMT100308-...-D39	32	320	363	70	40			
ED4100-50-8D-D19/W10	MD-190-EA	WOMT100308-...-D39	32	328	371	70	41	Key17-20		
ED4128-50-8D-D19/W10	MD-190-EA	WOMT100308-...-D39	32	331	374	70	41,28			
ED4200-50-8D-D19/W10	MD-190-EA	WOMT120408-...-D42	32	336	380	70	42	Key14-16		
ED4300-S0-8D-D16/W12	MD-160-EA	WOMT120408-...-D42	32	34	388	70	43			
ED4400-50-8D-D18/W12	MD-180-EA	WOMT120408-...-D42	32	352	396	70	44	Key17-20		
ED4445-50-8D-D18/W12	MD-180-EA	WOMT120408-...-D42	32	356	400	70	44,45			
ED4500-30-8D-D18/W12	MD-180-EA	WOMT120408-...-D42	32	360	404	70	45	Key14-16		
ED4600-50-8D-D19/W12	MD-190-EA	WOMT120408-...-D42	32	368	412	70	46			
ED4700-50-8D-D20/W12	MD-200-EA	WOMT120408-...-D42	32	376	420	70	47	Key17-20		
ED4763-30-8D-D21/W12	MD-210-EA	WOMT120408-...-D42	32	382	426	70	47,63			
ED4800-50-8D-D21/W12	MD-210-EA	WOMT120408-...-D42	32	384	429	70	48	Key21-28		
ED4900-50-8D-D22/W12	MD-220-EA	WOMT120408-...-D42	32	392	437	70	49			
ED5000-50-8D-D23/W12	MD-230-EA	WOMT120408-...-D42	32	400	445	70	50	Key14-16		
ED5080-S0-8D-D24/W12	MD-240-EA	WOMT120408-...-D42	32	407	452	70	50,8			
ED5100-50-8D-D24/W12	MD-240-EA	WOMT120408-...-D42	32	408	453	70	51	Key17-20		
ED5200-50-8D-D25/W12	MD-250-EA	WOMT120408-...-D42	32	416	461	70	52			
ED5300-30-8D-D26/W12	MD-260-EA	WOMT120408-...-D42	32	424	469	70	53	Key21-28		
ED5398-50-8D-D27/W12	MD-270-EA	WOMT120408-...-D42	32	432	477	70	53,98			
ED5400-50-8D-D27/W12	MD-270-EA	WOMT120408-...-D42	32	433	478	70	54	Key14-16		
ED5500-30-8D-D28/W12	MD-280-EA	WOMT120408-...-D42	32	440	485	70	55			

# RAPID DRILL

## RAPID DRILL

 ED...8D Yekpare Takım Tutucular  
ED...8D Solid Toolholders

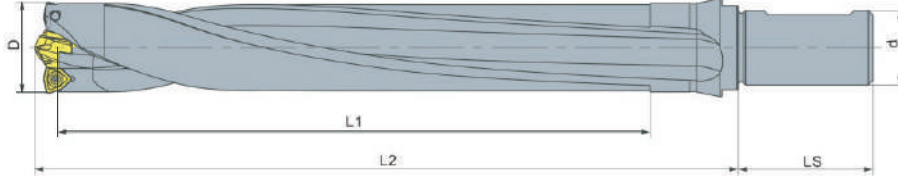

Ürün Kodu Order No	Merkez Matkap Başlığı Çapı Center Drill Head Dia	Yan Uç Side Inserts x2	Boyutlar Dimensions(mm)					Yedek Parça Spare Parts		
			d	L1	L2	Ls	D	Key17-20	M5X10	T20
ED5600-50-5D-D20/W15	MD-200-EA	WOMT150308-.-D55	50	448	493	70	56			
ED3700-50-3D-D21/W13	MD-210-EA	WOMT150308-.-D55	50	456	501	70	57			
ED5800-50-5D-D22/W15	MD-220-EA	WOMT150308-.-D55	50	464	509	70	58			
ED5900-50-5D-D22/W15	MD-230-EA	WOMT150308-.-D55	50	472	517	70	59			
ED6000-50-3D-D24/W15	MD-240-EA	WOMT150308-.-D55	50	480	525	70	60			
ED6100-50-3D-D25/W15	MD-250-EA	WOMT150308-.-D55	50	488	533	70	61			
ED6200-50-5D-D26/W15	MD-260-EA	WOMT150308-.-D55	50	496	541	70	62			
ED6300-50-5D-D27/W15	MD-270-EA	WOMT150308-.-D55	50	504	549	70	63			
ED6400-50-3D-D28/W15	MD-280-EA	WOMT150308-.-D55	50	512	557	70	64			
ED6500-50-5D-D29/W15	MD-290-EA	WOMT150308-.-D55	50	520	565	70	65			
ED6600-50-5D-D30/W15	MD-300-EA	WOMT150308-.-D55	50	528	573	70	66			
ED6700-50-5D-D31/W15	MD-310-EA	WOMT150308-.-D55	50	536	581	70	67			
EDG800-50-5D-D32/W15	MD-320-EA	WOMT150308-.-D55	50	544	589	70	68			
ED6900-50-5D-D33/W15	MD-330-EA	WOMT150308-.-D55	50	552	597	70	69			
ED7000-50-3D-D34/W15	MD-340-EA	WOMT150308-.-D55	50	560	605	70	70			
								Key29-34		

**ED...10D Yekpare Takım Tutucular**  
**ED...10D Solid Toolholders**

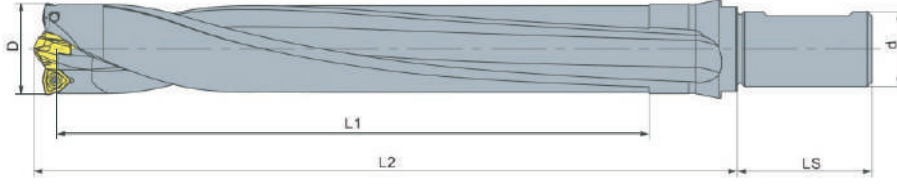

Ürün Kodu Order No	Merkez Matkap Başlığı Çapı Center Drill Head Dia	Yan Uç Side Inserts x2	Boyutlar Dimensions(mm)					Yedek Parça Spare Parts		
			d	L1	L2	Ls	D			
ED2800-32-10D-	MD-140-EA	AOMT040308	32	280	314	60	28	Key14-16	M2.5X8	T9
ED2858-32-10D-	MD-150-EA	AOMT040308	32	286	320	60	28,58			
ED2900-32-10D-	MD-160-EA	AOMT040308	32	290	324	60	29			
ED2936-32-10D-	MD-160-EA	AOMT040108	32	294	328	60	29,36			
ED3000-32-10D-	MD-160-EA	AOMT040308	32	300	335	60	30			
ED3018-32-10D-	MD-170-EA	AOMT040308	32	302	337	60	30,18			
ED3096-32-10D-	MD-170-EA	AOMT040308	32	310	345	60	30,96			
ED3100-32-10D-	MD-170-EA	AOMT040308	32	311	346	60	31			
ED3175-32-10D-	MD-150-EA	WOMT080308-...-D33	32	318	355	60	31,75			
ED3200-32-10D-	MD-150-EA	WOMT080308-...-D33	32	320	357	60	32			
ED3300-32-10D-	MD-160-EA	WOMT080308-...-D33	32	330	367	60	33			
ED3320-32-10D-	MD-160-EA	WOMT080308-...-D33	32	332	369	60	32,2			
ED3335-32-10D-	MD-160-EA	WOMT080308-...-D33	32	334	371	60	33,35			
ED3400-32-10D-	MD-160-EA	WOMT080308-...-D33	32	340	377	60	34			
ED3493-32-10D-	MD-180-EA	WOMT080308-...-D33	32	350	387	60	34,93			
ED3500-32-10D-	MD-180-EA	WOMT080308-...-D33	32	350	388	60	35			
ED3600-32-10D-	MD-180-EA	WOMT080308-...-D33	32	360	398	60	36			
ED3653-32-10D-	MD-190-EA	WOMT080308-...-D33	32	366	404	60	36,53			
ED3700-32-10D-	MD-160-EA	WOMT100308-...-D39	32	370	408	60	37			
ED3750-32-10D-	MD-160-EA	WOMT100308-...-D39	32	375	413	60	37,5			
ED3800-32-10D-	MD-160-EA	WOMT100308-...-D39	32	380	420	60	38			
ED3810-32-10D-	MD-160-EA	WOMT100308-...-D39	32	381	421	60	38,			
ED3900-32-10D-	MD-180-EA	WOMT100308-...-D39	32	390	430	60	39			
ED3920-32-10D-	MD-180-EA	WOMT100308-...-D39	32	392	432	60	39,2			
ED3970-32-10D-	MD-180-EA	WOMT100308-...-D39	32	397	437	60	39,7			
ED4000-50-10D-	MD-180-EA	WOMT100308-...-D39	32	400	443	60	40			
ED4100-50-10D-	MD-190-EA	WOMT100308-...-D39	32	410	453	70	41			
ED4128-50-10D-	MD-190-EA	WOMT100308-...-D39	32	413	454	70	41,28			
ED4200-50-10D-	MD-190-EA	WOMT120408-...-D42	32	420	464	70	42			
ED4300-50-10D-	MD-160-EA	WOMT120408-...-D42	32	430	474	70	43			
ED4400-50-10D-	MD-180-EA	WOMT120408-...-D42	32	440	484	70	44			
ED4445-50-10D-	MD-180-EA	WOMT120408-...-D42	32	445	489	70	44,45			
ED4500-30-10D-	MD-180-EA	WOMT120408-...-D42	32	450	494	70	45			
ED4600-50-10D-	MD-190-EA	WOMT120408-...-D42	32	460	504	70	46			
ED4700-50-10D-	MD-200-EA	WOMT120408-...-D42	32	470	514	70	47			
ED4763-30-10D-	MD-210-EA	WOMT120408-...-D42	32	477	521	70	47,63			
ED4800-50-10D-	MD-210-EA	WOMT120408-...-D42	32	480	525	70	48			
ED4900-50-10D-	MD-220-EA	WOMT120408-...-D42	32	490	535	70	49			
ED5000-50-10D-	MD-230-EA	WOMT120408-...-D42	32	500	545	70	50			
ED5080-S0-10D-	MD-240-EA	WOMT120408-...-D42	32	508	553	70	50,8			
ED5100-50-10D-	MD-240-EA	WOMT120408-...-D42	32	510	555	70	51			
ED5200-50-10D-	MD-250-EA	WOMT120408-...-D42	32	520	565	70	52			
ED5300-30-10D-	MD-260-EA	WOMT120408-...-D42	32	530	575	70	53			
ED5398-50-10D-	MD-270-EA	WOMT120408-...-D42	32	540	585	70	53,98			
ED5400-50-10D-	MD-270-EA	WOMT120408-...-D42	32	541	586	70	54			
ED5500-30-10D-	MD-280-EA	WOMT120408-...-D42	32	550	595	70	55			

**ED...10D Yekpare Takım Tutucular**  
**ED...10D Solid Toolholders**

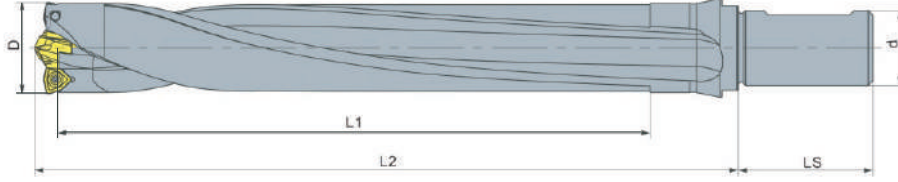

Ürün Kodu Order No	Merkez Matkap Başlığı Çapı Center Drill Head Dia	Yan Uç Side Inserts x2	Boyutlar Dimensions(mm)					Yedek Parça Spare Parts		
			d	L1	L2	Ls	D			
ED5600-50-10D-D20/W15	MD-200-EA	WOMT150308-...-D55	50	560	605	70	56	Key17-20	M5X10	T20
ED3700-50-10D-D21/W13	MD-210-EA	WOMT150308-...-D55	50	570	615	70	57			
ED5800-50-10D-D22/W15	MD-220-EA	WOMT150308-...-D55	50	580	625	70	58			
ED5900-50-10D-D23/W15	MD-230-EA	WOMT150308-...-D55	50	590	635	70	59			
ED6000-50-10D-D24/W15	MD-240-EA	WOMT150308-...-D55	50	600	645	70	60			
ED6100-50-10D-D25/W15	MD-250-EA	WOMT150308-...-D55	50	610	655	70	61			
ED6200-50-10D-D26/W15	MD-260-EA	WOMT150308-...-D55	50	620	665	70	62			
ED6300-50-10D-D27/W15	MD-270-EA	WOMT150308-...-D55	50	630	675	70	63			
ED6400-50-10D-D28/W15	MD-280-EA	WOMT150308-...-D55	50	640	685	70	64			
ED6500-50-10D-D29/W15	MD-290-EA	WOMT150308-...-D55	50	650	695	70	65			
ED6600-50-10D-D30/W15	MD-300-EA	WOMT150308-...-D55	50	660	705	70	66	Key21-28	M5X10	T20
ED6700-50-10D-D31/W15	MD-310-EA	WOMT150308-...-D55	50	670	715	70	67			
EDG800-50-10D-D32/W15	MD-320-EA	WOMT150308-...-D55	50	680	725	70	68			
ED6900-50-10D-D33/W15	MD-330-EA	WOMT150308-...-D55	50	690	735	70	69			
ED7000-50-10D-D34/W15	MD-340-EA	WOMT150308-...-D55	50	700	745	70	70			



**Çoklu Uç Hattı Modüler Takım Tutucu Kod Sistemi**  
**Multi Insert Line Modular Toolholder Code System**

**Kesme Ünitesi Sipariş Kodu Sistemi**  
**Cutting Unit Ordering Code System**

ED

1

3300

2

D16

3

W08

4

1 ED 3300 D16 W08

ED: E-DRILL  
 Kesme Birimi  
 Cutting Unit

2 ED 3300 D16 W08

Matkap Çapı  
 Drill Dia.  
 30,0mm (28-55)

3 ED 3300 D16 W08

Merkez Matkap Başlığı Çapı  
 Center Drill Head Dia.  
 16mm

4 ED 3300 D16 W08

Kesici Uç Genişliği 8mm  
 Side Insert Length 8mm

**Tutucu Birim Sipariş Kodu Sistemi**  
**Holder Unit Ordering Code System**

ED

1

31

2

32

3

3D

4

1 ED 31 32 3D

ED: E-DRILL  
 Tutucu Birimi  
 Holder Unit

2 ED 31 32 3D

Tutucu Çapı  
 Holder Dia.  
 mm

3 ED 31 32 3D

Sap Çapı  
 Shank Dia.  
 32,0 mm

4 ED 31 32 3D

Tutucu Uzunluğu  
 Holder Length

# RAPID DRILL

## RAPID DRILL

### MD...EA Merkez Matkap Ucu MD...EA Center Drill Insert

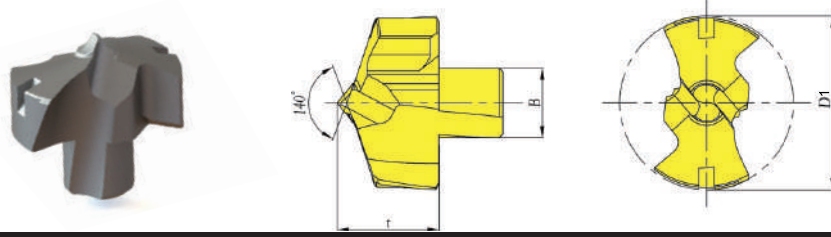

Ürün Kodu Order Code	Boyutlar Dimensions (mm)		
MD-140-EA	14	6	8,1
MD-150-EA	15	6	8,7
MD-160-EA	16	8	8,8
MD-170-EA	17	8	9,9
MD-180-EA	18	8	10,5
MD-190-EA	19	8	11,5
MD-200-EA	20	8	11,6
MD-210-EA	21	8	12,1
MD-220-EA	22	10	12,7
MD-230-EA	23	10	13,3
MD-240-EA	24	12	13,9
MD-250-EA	25	12	14,5
MD-260-EA	26	12	14,5
MD-270-EA	27	12	15,5
MD-280-EA	28	12	15,5
MD-290-EA	29	14	15,5
MD-300-EA	30	14	15,5
MD-310-EA	31	14	15,5
MD-320-EA	32	14	16,5
MD-330-EA	33	14	16,5
MD-340-EA	34	14	16,5

### WOMT...W... Yan Uçlar WOMT...W... Side Inserts

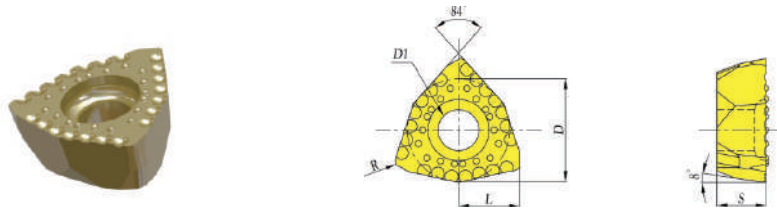

Ürün Kodu Order Code	Boyutlar Dimensions (mm)			
	D	D1	R	S
WOMT080308-W5-D33	8	3,4	0,8	3,75
WOMT100308-W5-D39	10	4,4	0,8	3,75
WOMT120408-W5-D42	12	4,4	0,8	4,75
WOMT150508-W5-D55	15	5,5	0,8	5,25

## RAPID DRILL

## RAPID DRILL

### WOMT...W... Yan Uçlar WOMT...W... Side Inserts

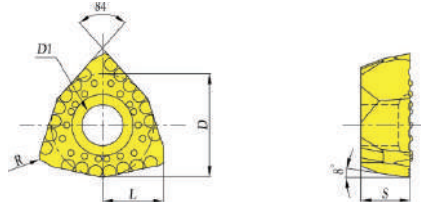

Ürün Kodu Order Code	Boyutlar Dimensions (mm)			
	D	D1	R	S
WOMT080308-W6-D33	8	3,4	0,8	3,75
WOMT100308-W6-D39	10	4,4	0,8	3,75
WOMT120408-W6-D42	12	4,4	0,8	4,75
WOMT150508-W6-D55	15	5,5	0,8	5,25

### WOMT...V... Yan Uçlar WOMT...V... Side Inserts

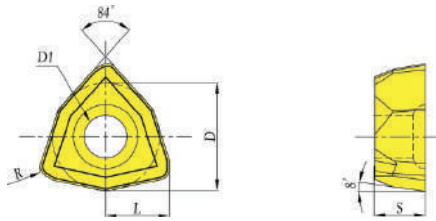
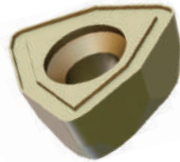

Ürün Kodu Order Code	Boyutlar Dimensions (mm)			
	D	D1	R	S
WOMT080308-V1-D33	8	3,4	0,8	3,75
WOMT100308-V1-D39	10	4,4	0,8	3,75
WOMT120408-V1-D42	12	4,4	0,8	4,75
WOMT150508-V1-DSC	15	5,5	0,8	5,25
WOMT080308-V2-D33	8	3,4	0,8	3,75
WOMT100308-V2-D39	10	4,4	0,8	3,75
WOMT120408-V2-D42	12	4,4	0,8	4,75
WOMT150508-V2-DSC	15	5,5	0,8	5,25

### AOMT...Yan Uçlar AOMT...Side Inserts

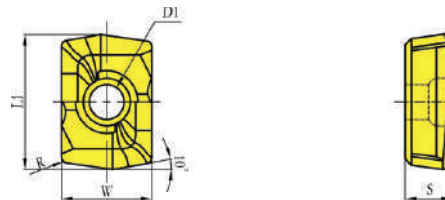

Ürün Kodu Order Code	Boyutlar Dimensions (mm)				
	W	L1	D1	R	S
AOMT040308	7,26	10,76	2,85	0,4	3,79

# RAPID DRILL

# RAPID DRILL



Matkap Başlığı  
Drill Head

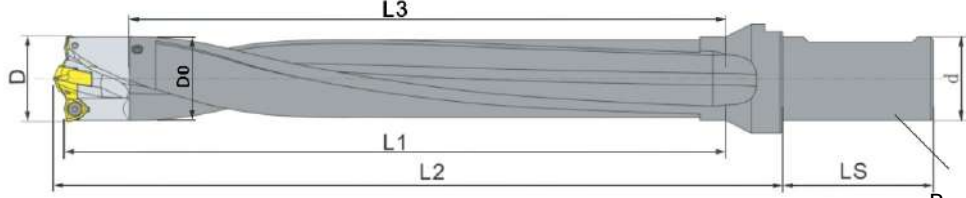

Başlık Birimi  
Holder Unit

Kesici Birimi Cutting Unit	Matkap Çapı D Drill Dia D (mm)	Merkez Matkap Başlığı Çapı D1 Center Drill Head Dia D0	Yan Uç Side Inserts x1	Tutucu Birimi Holder Unit	Boyutlar Dimensions (mm)						Arayüzey Kodu Interface Code	Yedek Parça Spare Parts			
					D2	D0	d	L1	L2	L3		LS			
E2800-D14/A04	28,00	MD-140-EA	AOMT040308	S27-32-3D	27,5	27	32	95	134	75	60	IF28	Key14-16	M2,5x8	T9
E2858-D15/A04	28,58	MD-150-EA	AOMT040308		27,5	27	32	95	134	75	60				
E2900-D16/A04	29,00	MD-160-EA	AOMT040308		27,5	27	32	95	134	75	60				
E2936-D16/A04	29,36	MD-160-EA	AOMT040308		27,5	27	32	95	134	75	60				
E3000-D16/A04	30,00	MD-160-EA	AOMT040308	S29-32-3D	29,5	29	32	100	138	80	60	Key17-20			
E3018-D17/A04	30,18	MD-170-EA	AOMT040308		29,5	29	32	100	138	80	60				
E3096-D17/A04	30,96	MD-170-EA	AOMT040308		29,5	29	32	100	138	80	60				
E3100-D17/A04	31,00	MD-170-EA	AOMT040308		29,5	29	32	100	138	80	60				
E3175-D15/W08	31,75	MD-150-EA	WOMT080308...-D33	S31-32-3D	31,25	30,75	32	112	148	90	60	IF32	Key14-16	M3X10	T10
E3200-D15/W08	32,00	MD-150-EA	WOMT080308...-D33		31,25	30,75	32	112	148	90	60				
E3300-D15/W08	33,00	MD-160-EA	WOMT080308...-D33		31,25	30,75	32	112	148	90	60				
E3320-D15/W08	33,20	MD-160-EA	WOMT080308...-D33		31,25	30,75	32	112	148	90	60				
E3335-D15/W08	33,35	MD-160-EA	WOMT080308...-D33	S34-32-3D	31,25	30,75	32	112	148	90	60	Key17-20			
E3400-D16/W08	34,00	MD-160-EA	WOMT080308...-D33		31,25	30,75	32	112	148	90	60				
E3493-D18/W08	34,93	MD-180-EA	WOMT080308...-D33		31,25	30,75	32	112	148	90	60				
E3500-D18/W08	35,00	MD-180-EA	WOMT080308...-D33		34,5	34	32	122	160	100	60				
E3600-D18/W08	36,00	MD-180-EA	WOMT080308...-D33	S37-32-3D	34,5	34	32	122	160	100	60	IF38	Key14-16		
E3653-D19/W08	36,53	MD-190-EA	WOMT080308...-D33		34,5	34	32	122	160	100	60				
E3700-D16/W10	37,00	MD-160-EA	WOMT080308...-D33		34,5	34	32	122	160	100	60				
E3750-D16/W10	37,50	MD-160-EA	WOMT080308...-D33		34,5	34	32	122	160	100	60				
E3800-D16/W10	38,00	MD-160-EA	WOMT080308...-D33	S39-50-3D	37,5	37	32	125	165	100	60	Key17-20			
E3810-D16/W10	38,10	MD-160-EA	WOMT080308...-D33		37,5	37	32	125	165	100	60				
E3900-D18/W10	39,00	MD-180-EA	WOMT080308...-D33		37,5	37	32	125	165	100	60				
E3920-D18/W10	39,20	MD-180-EA	WOMT080308...-D33		37,5	37	32	125	165	100	60				
E3970-D18/W10	39,70	MD-180-EA	WOMT080308...-D33	S41-50-3D	37,5	37	32	125	165	100	60	IF42	Key14-16	M4X12	T15
E4000-D18/W10	40,00	MD-180-EA	WOMT080308...-D33		39,5	39	50	135	180	110	70				
E4100-D19/W10	41,00	MD-190-EA	WOMT080308...-D33		39,5	39	50	135	180	110	70				
E4128-D19/W10	41,28	MD-190-EA	WOMT080308...-D33		39,5	39	50	135	180	110	70				
E4200-D19/W10	42,00	MD-190-EA	WOMT120408...-D42	S44-50-3D	41,5	41	50	140	185	115	70	Key17-20			
E4300-D16/W12	43,00	MD-160-EA	WOMT120408...-D42		41,5	41	50	140	185	115	70				
E4400-D18/W12	44,00	MD-180-EA	WOMT120408...-D42		41,5	41	50	140	185	115	70				
E4445-D18/W12	44,45	MD-180-EA	WOMT120408...-D42		41,5	41	50	140	185	115	70				
E4500-D18/W12	45,00	MD-180-EA	WOMT120408...-D42	S47-50-3D	44,5	44	50	150	195	124	70	IF48	Key21-28		
E4600-D19/W12	46,00	MD-190-EA	WOMT120408...-D42		44,5	44	50	150	195	124	70				
E4700-D20/W12	47,00	MD-200-EA	WOMT120408...-D42		44,5	44	50	150	195	124	70				
E4763-D21/W12	47,63	MD-210-EA	WOMT120408...-D42		44,5	44	50	150	195	124	70				
E4800-D21/W12	48,00	MD-210-EA	WOMT120408...-D42	S50-50-3D	47	47	50	160	200	135	70	Key17-20			
E4900-D22/W12	49,00	MD-220-EA	WOMT120408...-D42		47	47	50	160	200	135	70				
E5000-D23/W12	50,00	MD-230-EA	WOMT120408...-D42		47	47	50	160	200	135	70				
E5080-D24/W12	50,80	MD-240-EA	WOMT120408...-D42		49,8	49,8	50	170	210	135	70				
E5100-D24/W12	51,00	MD-240-EA	WOMT120408...-D42	S53-50-3D	49,8	49,8	50	170	210	135	70				
E5200-D25/W12	52,00	MD-250-EA	WOMT120408...-D42		49,8	49,8	50	170	210	135	70				
E5300-D26/W12	53,00	MD-260-EA	WOMT120408...-D42		49,8	49,8	50	170	210	135	70				
E5398-D27/W12	53,98	MD-270-EA	WOMT120408...-D42		53,4	53	50	175	215	140	70				
E5400-D27/W12	54,00	MD-270-EA	WOMT120408...-D42	S53-50-3D	53,4	53	50	175	215	140	70				
E5550-D28/W12	55,00	MD-280-EA	WOMT120408...-D42		53,4	53	50	175	215	140	70				

# RAPID DRILL

# RAPID DRILL

**5D...Takım Tutucular**  
**5D...Toolholders**

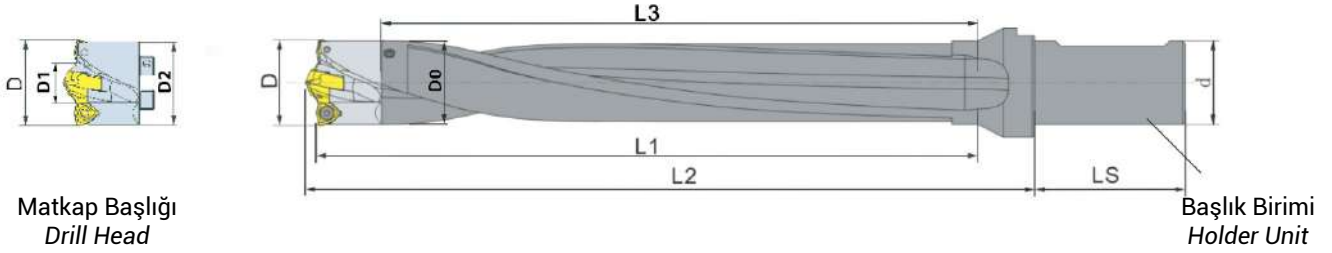

Kesici Birimi Cutting Unit	Matkap Çapı D Drill Dia D (mm)	Merkez Matkap Başlığı Çapı D1 Center Drill Head Dia D0	Yan Uç Side Inserts x1	Tutucu Birimi Holder Unit	Boyutlar Dimensions (mm)								Arayüzey Kodu Interface Code	Yedek Parça Spare Parts		
					D2	D0	d	L1	L2	L3	LS	Key		M	T	
E2800-D14/A04	28,00	MD-140-EA	AOMT040308	S27-32-5D	27,5	27	32	155	194	135	60	IF28	Key14-16	M2.5X8	T9	
E2858-D15/A04	28,58	MD-150-EA	AOMT040308		27,5	27	32	155	194	135	60					
E2900-D16/A04	29,00	MD-160-EA	AOMT040308		27,5	27	32	155	194	135	60					
E2936-D16/A04	29,36	MD-160-EA	AOMT040308		27,5	27	32	155	194	135	60					
E3000-D16/A04	30,00	MD-160-EA	AOMT040308		29,5	29	32	160	199	140	60					
E3018-D17/A04	30,18	MD-170-EA	AOMT040308		29,5	29	32	160	199	140	60					
E3096-D17/A04	30,96	MD-170-EA	AOMT040308	S29-32-5D	29,5	29	32	160	199	140	60	Key17-20				
E3100-D17/A04	31,00	MD-170-EA	AOMT040308		29,5	29	32	160	199	140	60					
E3175-D15/W08	31,75	MD-150-EA	WOMT080308-...-D33		31,25	30,75	32	177	212	155	60					
E3200-D13/W08	32,00	MD-150-EA	WOMT080308-...-D33	S31-32-5D	31,25	30,75	32	177	212	155	60	IF32	Key14-16	M3X10	T10	
E3300-D16/W08	33,00	MD-160-EA	WOMT080308-...-D33		31,25	30,75	32	177	212	155	60					
E3320-D16/W08	33,20	MD-160-EA	WOMT080308-...-D23		31,25	30,75	32	177	212	155	60					
E3333-D16/W08	33,33	MD-160-EA	WOMT080308-...-D33		31,25	30,75	32	177	212	155	60					
E3400-D16/W08	34,00	MD-160-EA	WOMT080308-...-D31		31,25	30,75	32	177	212	155	60					
E3493-D18/W08	34,93	MD-180-EA	WOMT080308-...-D33		31,25	30,75	32	177	212	155	60					
E3500-D18/W08	35,00	MD-180-EA	WOMT080308-...-D33	S34-32-5D	34,5	34	32	192	230	170	60	Key17-20				
E3600-D18/W08	36,00	MD-180-EA	WOMT080308-...-D33		34,5	34	32	192	230	170	60					
E3653-D19/W08	36,53	MD-190-EA	WOMT080308-...-D33		34,5	34	32	192	230	170	60					
E3700-D16/W10	37,00	MD-160-EA	WOMT100308-...-D39	S37-32-5D	34,5	34	32	192	230	170	60	IF8	Key14-16			
E3730-D16/W10	37,50	MD-160-EA	WOMT100308-...-D39		34,5	34	32	192	230	170	60					
E3800-D16/W10	38,00	MD-160-EA	WOMT100308-...-D39		37,5	37	32	215	245	190	60					
E3810-D16/W10	38,10	MD-160-EA	WOMT100308-...-D29		37,5	37	32	215	245	190	60					
E3900-D18/W10	39,00	MD-180-EA	WOMT100308-...-D39		37,5	37	32	213	243	190	60					
E3920-D18/W10	39,20	MD-180-EA	WOMT100308-...-D39		37,5	37	32	215	245	190	60					
E3970-D18/W10	39,70	MD-180-EA	WOMT100308-...-D39	S39-50-5D	37,5	37	32	215	245	190	60	Key17-20				
E4000-D18/W10	40,00	MD-180-EA	WOMT100308-...-D39		39,5	39	50	220	265	195	70					
E4100-D19/W10	41,00	MD-190-EA	WOMT100308-...-D39		39,5	39	50	220	265	195	70					
E4128-D19/W10	41,28	MD-190-EA	WOMT100308-...-D39	S41-50-5D	39,5	39	50	220	265	195	70	IF42	Key14-16	M4X12	T15	
E4200-D19/W10	42,00	MD-190-EA	WOMT120408-...-D42		41,5	41	50	230	277	205	70					
E4300-D16/W12	43,00	MD-160-EA	WOMT120408-...-D42		41,5	41	50	230	277	205	70					
E4400-D18/W12	44,00	MD-180-EA	WOMT120408-...-D42		41,5	41	50	230	277	205	70					
E4445-D18/W12	44,45	MD-180-EA	WOMT120408-...-D42		41,5	41	50	230	277	205	70					
E4500-D18/W12	45,00	MD-180-EA	WOMT120408-...-D42		44,5	44	50	243	283	219	70					
E4600-D19/W12	46,00	MD-190-EA	WOMT120408-...-D42	S47-50-5D	44,5	44	50	243	283	219	70	Key17-20				
E4700-D20/W12	47,00	MD-200-EA	WOMT120408-...-D42		44,5	44	50	243	283	219	70					
E4763-D21/W12	47,63	MD-210-EA	WOMT120408-...-D42		44,5	44	50	243	283	219	70					
E4800-D21/W12	48,00	MD-210-EA	WOMT120408-...-D42	S47-50-5D	47,5	47	50	260	305	225	70	Key17-20				
E4900-D22/W12	49,00	MD-220-EA	WOMT120408-...-D42		47,5	47	50	260	305	225	70					
E5000-D23/W12	50,00	MD-230-EA	WOMT120408-...-D42		47,5	47	50	260	305	225	70					
E5080-D24/W12	50,80	MD-240-EA	WOMT120408-...-D42	S50-50-5D	50,3	49,8	50	275	315	240	70	IF48	Key21-28			
E5100-D24/W12	51,00	MD-240-EA	WOMT120408-...-D42		50,3	49,8	50	275	315	240	70					
E5200-D25/W12	52,00	MD-250-EA	WOMT120408-...-D42		50,3	49,8	50	275	315	240	70					
E5300-D26/W12	53,00	MD-260-EA	WOMT120408-...-D42		50,3	49,8	50	275	315	240	70					
E5398-D27/W12	53,98	MD-270-EA	WOMT120408-...-D42		53,4	53	50	280	320	245	70					
E5400-D27/W12	54,00	MD-270-EA	WOMT120408-...-D42		53,4	53	50	280	320	245	70					
E5500-D28/W12	55,00	MD-280-EA	WOMT120408-...-D42	S53-50-5D	53,4	53	50	280	320	245	70	Key17-20				
					53,4	53	50	280	320	245	70					

# RAPID DRILL

## RAPID DRILL

**6D...Takım Tutucular**  
**6D...Toolholders**

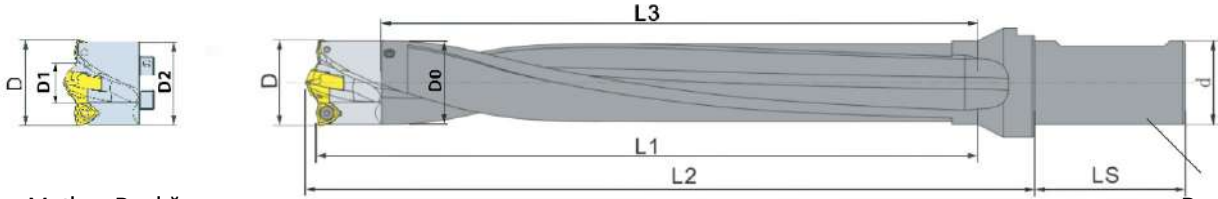

Matkap Başlığı  
Drill Head

Başlık Birimi  
Holder Unit

Kesici Birimi Cutting Unit	Matkap Çapı D Drill Dia D (mm)	Merkez Matkap Başlığı Çapı D1 Center Drill Head Dia D0	Yan Uç Side Inserts x1	Tutucu Birimi Holder Unit	Boyutlar Dimensions (mm)						Arayüzey Kodu Interface Code	Yedek Parça Spare Parts			
					D2	D0	d	L1	L2	L3		LS			
E2800-D14/A04	28.00	MD-140-EA	AOMT040308	S27-32-6D	27.5	27	32	180	220	160	60	IF28	Key14-16	M2.5X8	T9
E2858-D15/A04	28.58	MD-150-EA	AOMT040308		27.5	27	32	180	220	160	60				
E2900-D16/A04	29.00	MD-160-EA	AOMT040308		27.5	27	32	180	220	160	60				
E2936-D16/A04	29.36	MD-160-EA	AOMT040308		27.5	27	32	180	220	160	60				
E3000-D16/A04	30.00	MD-160-EA	AOMT040308	S29-32-6D	29.5	29	32	195	23	175	60				
E3018-D17/A04	30.18	MD-170-EA	AOMT040308		29.5	29	32	195	233	175	60				
E3096-D17/A04	30.96	MD-170-EA	AOMT040308		29.5	29	32	195	233	175	60				
E3100-D17/A04	31.00	MD-170-EA	AOMT040308		29.5	29	32	195	233	175	60				
E3175-D15/W08	31.75	MD-150-EA	WOMT080308-...-D33	S31-32-6D	31.25	30.75	32	211	246	189	60	IF32	Key14-16	M3X10	T10
E3200-D13/W08	32.00	MD-150-EA	WOMT080308-...-D33		31.25	30.75	32	211	246	189	60				
E3300-D16/W08	33.00	MD-160-EA	WOMT080308-...-D33		31.25	30.75	32	211	246	189	60				
E3320-D16/W08	33.20	MD-160-EA	WOMT080308-...-D33		31.25	30.75	32	211	246	189	60				
E3333-D16/W08	33.33	MD-160-EA	WOMT080308-...-D33		31.25	30.75	32	211	246	189	60				
E3400-D16/W08	34.00	MD-160-EA	WOMT080308-...-D31		31.25	30.75	32	211	246	189	60				
E3493-D18/W08	34.93	MD-180-EA	WOMT080308-...-D33		31.25	30.75	32	211	246	189	60				
E3500-D18/W08	35.00	MD-180-EA	WOMT080308-...-D33		34.5	34	32	227	265	205	60				
E3600-D18/W08	36.00	MD-180-EA	WOMT080308-...-D33	34.5	34	32	227	265	205	60					
E3653-D19/W08	36.53	MD-190-EA	WOMT080308-...-D33	S34-32-6D	34.5	34	32	227	265	205	60	Key17-20			
E3700-D16/W10	37.00	MD-160-EA	WOMT100308-...-D39		34.5	34	32	227	265	205	60				
E3730-D16/W10	37.30	MD-160-EA	WOMT100308-...-D39		34.5	34	32	227	265	205	60				
E3800-D16/W10	38.00	MD-160-EA	WOMT100308-...-D39		34.5	34	32	227	265	205	60				
E3810-D16/W10	38.10	MD-160-EA	WOMT100308-...-D79	S37-32-6D	37.5	37	32	255	290	230	60	IF'8	Key14-16		
E3900-D18/W10	39.00	MD-180-EA	WOMT100308-...-D39		37.5	37	32	255	290	230	60				
E3920-D18/W10	39.20	MD-180-EA	WOMT100308-...-D39		37.5	37	32	255	290	230	60				
E3970-D18/W10	39.70	MD-180-EA	WOMT100308-...-D39		37.5	37	32	255	290	230	60				
E4000-D18/W10	40.00	MD-180-EA	WOMT100308-...-D39	S39-50-6D	39.5	39	50	257	305	232	70	Key17-20			
E4100-D19/W10	41.00	MD-190-EA	WOMT100308-...-D39		39.5	39	50	257	305	232	70				
E4128-D19/W10	41.28	MD-190-EA	WOMT100308-...-D39		39.5	39	50	257	305	232	70				
E4200-D19/W10	42.00	MD-190-EA	WOMT120408-...-D42		41.5	41	50	275	320	250	70				
E4300-D16/W12	43.00	MD-160-EA	WOMT120408-...-D42	S41-50-6D	41.5	41	50	275	320	250	70	Key14-16			
E4300-D16/W12	43.00	MD-160-EA	WOMT120408-...-D42		41.5	41	50	275	320	250	70				
E4400-D18/W12	44.00	MD-180-EA	WOMT120408-...-D42		41.5	41	50	275	320	250	70				
E4445-D18/W12	44.45	MD-180-EA	WOMT120408-...-D42		41.5	41	50	275	320	250	70				
E4500-D18/W12	45.00	MD-180-EA	WOMT120408-...-D42	S47-50-6D	44.5	44	50	295	350	269	70	IF42	Key17-20	M4X12	T15
E4600-D19/W12	46.00	MD-190-EA	WOMT120408-...-D42		44.5	44	50	295	350	269	70				
E4700-D20/W12	47.00	MD-200-EA	WOMT120408-...-D42		44.5	44	50	295	350	269	70				
E4763-D21/W12	47.63	MD-210-EA	WOMT120408-...-D42		44.5	44	50	295	350	269	70				
E4800-D21/W12	48.00	MD-210-EA	WOMT120408-...-D42	S47-50-6D	47.5	47	50	310	350	275	70	IF48	Key21-28		
E4900-D22/W12	49.00	MD-220-EA	WOMT120408-...-D42		47.5	47	50	310	350	275	70				
E5000-D23/W12	50.00	MD-230-EA	WOMT120408-...-D42		47.5	47	50	310	350	275	70				
E5080-D24/W12	50.80	MD-240-EA	WOMT120408-...-D42		50.3	49.8	50	330	370	295	70				
E5100-D24/W12	51.00	MD-240-EA	WOMT120408-...-D42	S50-50-6D	50.3	49.8	50	330	370	295	70				
E5200-D25/W12	52.00	MD-250-EA	WOMT120408-...-D42		50.3	49.8	50	330	370	295	70				
E5300-D26/W12	53.00	MD-260-EA	WOMT120408-...-D42		50.3	49.8	50	330	370	295	70				
E5398-D27/W12	53.98	MD-270-EA	WOMT120408-...-D42		53.4	53	50	340	380	305	70				
E5400-D27/W12	54.00	MD-270-EA	WOMT120408-...-D42	S53-50-6D	53.4	53	50	340	380	305	70				
E5500-D28/W12	55.00	MD-280-EA	WOMT120408-...-D42		53.4	53	50	340	380	245	70				

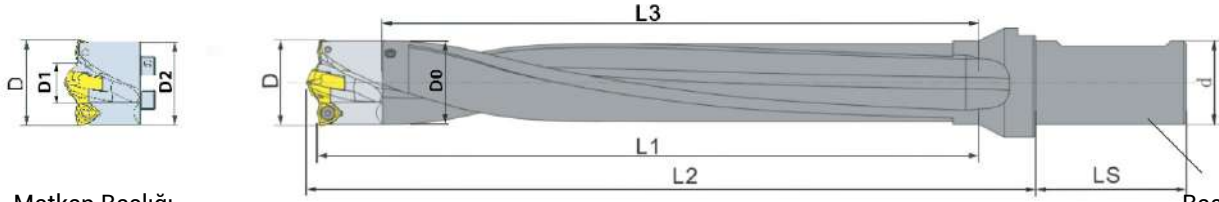

Matkap Başlığı  
Drill Head

Başlık Birimi  
Holder Unit

Kesici Birimi Cutting Unit	Matkap Çapı D Drill Dia D (mm)	Merkez Matkap Başlığı Çapı D1 Center Drill Head Dia D0	Yan Uç Side Inserts x1	Boyutlar Dimensions (mm)							Arayüzey Kodu Interface Code	Yedek Parça Spare Parts			
				D2	D0	d	L1	L2	L3	LS					
E2800-D14/A04	28,00	MD-140-EA	AOMT040308	S27-32-7D	27,5	27	32	215	255	195	60	IF28	Key14-16	M2,5X8	T9
E2858-D15/A04	28,58	MD-150-EA	AOMT040308		27,5	27	32	215	255	195	60				
E2900-D16/A04	29,00	MD-160-EA	AOMT040308	S29-32-7D	27,5	27	32	215	255	195	60	IF32	Key14-16	M3X10	T10
E2936-D16/A04	29,36	MD-160-EA	AOMT040308		27,5	27	32	215	255	195	60				
E3000-D16/A04	30,00	MD-160-EA	AOMT040308	S31-32-7D	29,5	29	32	220	258	200	60	IF32	Key14-16	M3X10	T10
E3018-D17/A04	30,18	MD-170-EA	AOMT040308		29,5	29	32	220	258	200	60				
E3096-D17/A04	30,96	MD-170-EA	AOMT040308	S34-32-7D	29,5	29	32	220	258	200	60	IF32	Key17-20	M3X10	T10
E3100-D17/A04	31,00	MD-170-EA	AOMT040308		29,5	29	32	220	258	200	60				
E3175-D15/W08	31,75	MD-150-EA	WOMT080308-...-D33	S37-32-7D	31,25	30,75	32	251	286	229	60	IF'8	Key14-16	M4X12	T15
E3200-D13/W08	32,00	MD-150-EA	WOMT080308-...-D33		31,25	30,75	32	251	286	229	60				
E3300-D16/W08	33,00	MD-160-EA	WOMT080308-...-D33	S39-50-7D	31,25	30,75	32	251	286	229	60	IF42	Key17-20	M4X12	T15
E3320-D16/W08	33,20	MD-160-EA	WOMT080308-...-D33		31,25	30,75	32	251	286	229	60				
E3333-D16/W08	33,33	MD-160-EA	WOMT080308-...-D33	S41-50-7D	31,25	30,75	32	251	286	229	60	IF42	Key17-20	M4X12	T15
E3400-D16/W08	34,00	MD-160-EA	WOMT080308-...-D33		31,25	30,75	32	251	286	229	60				
E3493-D18/W08	34,93	MD-180-EA	WOMT080308-...-D33	S47-50-7D	31,25	30,75	32	251	286	229	60	IF48	Key21-28	M4X12	T15
E3500-D18/W08	35,00	MD-180-EA	WOMT080308-...-D33		34,5	34	32	272	308	250	60				
E3600-D18/W08	36,00	MD-180-EA	WOMT080308-...-D33	S47-50-7D	34,5	34	32	272	308	250	60	IF48	Key21-28	M4X12	T15
E3653-D19/W08	36,53	MD-190-EA	WOMT080308-...-D33		34,5	34	32	272	308	250	60				
E3700-D16/W10	37,00	MD-160-EA	WOMT100308-...-D39	S50-50-7D	34,5	34	32	272	308	250	60	IF48	Key21-28	M4X12	T15
E3730-D16/W10	37,50	MD-160-EA	WOMT100308-...-D39		34,5	34	32	272	308	250	60				
E3800-D16/W10	38,00	MD-160-EA	WOMT100308-...-D39	S53-50-7D	37,5	37	32	295	329	270	60	IF48	Key21-28	M4X12	T15
E3810-D16/W10	38,10	MD-160-EA	WOMT100308-...-D39		37,5	37	32	295	329	270	60				
E3900-D18/W10	39,00	MD-180-EA	WOMT100308-...-D39	S53-50-7D	37,5	37	32	295	329	270	60	IF48	Key21-28	M4X12	T15
E3920-D18/W10	39,20	MD-180-EA	WOMT100308-...-D39		37,5	37	32	295	329	270	60				
E3970-D18/W10	39,70	MD-180-EA	WOMT100308-...-D39	S53-50-7D	37,5	37	32	295	329	270	60	IF48	Key21-28	M4X12	T15
E4000-D18/W10	40,00	MD-180-EA	WOMT100308-...-D39		39,5	39	50	300	343	275	70				
E4100-D19/W10	41,00	MD-190-EA	WOMT100308-...-D39	S53-50-7D	39,5	39	50	300	343	275	70	IF48	Key21-28	M4X12	T15
E4128-D19/W10	41,28	MD-190-EA	WOMT100308-...-D39		39,5	39	50	300	343	275	70				
E4200-D19/W10	42,00	MD-190-EA	WOMT120408-...-D42	S53-50-7D	41,5	41	50	320	360	295	70	IF48	Key21-28	M4X12	T15
E4300-D16/W12	43,00	MD-160-EA	WOMT120408-...-D42		41,5	41	50	320	360	295	70				
E4400-D18/W12	44,00	MD-180-EA	WOMT120408-...-D42	S53-50-7D	41,5	41	50	320	360	295	70	IF48	Key21-28	M4X12	T15
E4445-D18/W12	44,45	MD-180-EA	WOMT120408-...-D42		41,5	41	50	320	360	295	70				
E4500-D18/W12	45,00	MD-180-EA	WOMT120408-...-D42	S53-50-7D	44,5	44	50	346	390	320	70	IF48	Key21-28	M4X12	T15
E4600-D19/W12	46,00	MD-190-EA	WOMT120408-...-D42		44,5	44	50	346	390	320	70				
E4700-D20/W12	47,00	MD-200-EA	WOMT120408-...-D42	S53-50-7D	44,5	44	50	346	390	320	70	IF48	Key21-28	M4X12	T15
E4763-D21/W12	47,63	MD-210-EA	WOMT120408-...-D42		44,5	44	50	346	390	320	70				
E4800-D21/W12	48,00	MD-210-EA	WOMT120408-...-D42	S53-50-7D	47,5	47	50	360	400	325	70	IF48	Key21-28	M4X12	T15
E4900-D22/W12	49,00	MD-220-EA	WOMT120408-...-D42		47,5	47	50	360	400	325	70				
E5000-D23/W12	50,00	MD-230-EA	WOMT120408-...-D42	S53-50-7D	47,5	47	50	360	400	325	70	IF48	Key21-28	M4X12	T15
E5080-D24/W12	50,80	MD-240-EA	WOMT120408-...-D42		50,3	49,8	50	375	415	340	70				
E5100-D24/W12	51,00	MD-240-EA	WOMT120408-...-D42	S53-50-7D	50,3	49,8	50	375	415	340	70	IF48	Key21-28	M4X12	T15
E5200-D25/W12	52,00	MD-250-EA	WOMT120408-...-D42		50,3	49,8	50	375	415	340	70				
E5300-D26/W12	53,00	MD-260-EA	WOMT120408-...-D42	S53-50-7D	50,3	49,8	50	375	415	340	70	IF48	Key21-28	M4X12	T15
E5398-D27/W12	53,98	MD-270-EA	WOMT120408-...-D42		53,4	53	50	385	425	350	70				
E5400-D27/W12	54,00	MD-270-EA	WOMT120408-...-D42	S53-50-7D	53,4	53	50	385	425	350	70	IF48	Key21-28	M4X12	T15
E5500-D28/W12	55,00	MD-280-EA	WOMT120408-...-D42		53,4	53	50	385	425	350	70				



# RAPID DRILL

# RAPID DRILL

**8D...Takım Tutucular**  
**8D...Toolholders**

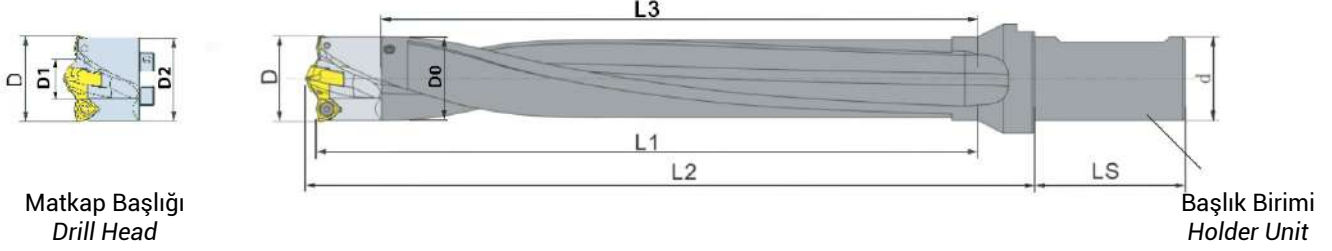

Kesici Birimi Cutting Unit	Matkap Çapı D Drill Dia D (mm)	Merkez Matkap Başlığı Çapı D1 Center Drill Head Dia D0	Yan Uç Side Inserts x1	Tutucu Birimi Holder Unit	Boyutlar Dimensions (mm)							Arayüzey Kodu Interface Code	Yedek Parça Spare Parts		
					D2	D0	d	L1	L2	L3	LS		Key14-16	M2.5X8	T9
E2800-D14/A04	28.00	MD-140-EA	AOMT040308	S27-32-8D	27.5	27	32	245	285	225	60	IF28	Key14-16	M2.5X8	T9
E2858-D15/A04	28.58	MD-150-EA	AOMT040308		27.5	27	32	245	285	225	60				
E2900-D16/A04	29.00	MD-160-EA	AOMT040308		27.5	27	32	245	285	225	60				
E2936-D16/A04	29.36	MD-160-EA	AOMT040308		27	27	32	245	285	225	60				
E3000-D16/A04	30.00	MD-160-EA	AOMT040308	S29-32-8D	29.5	29	32	250	288	230	60	IF32	Key14-16	M3X10	T10
E3018-D17/A04	30.18	MD-170-EA	AOMT040308		29.5	29	32	250	288	230	60				
E3096-D17/A04	30.96	MD-170-EA	AOMT040308		29.5	29	32	250	288	230	60				
E3100-D17/A04	31.00	MD-170-EA	AOMT040308		29.5	29	32	250	288	230	60				
E3175-D15/W08	31.75	MD-150-EA	WOMT080308--D33	S31-32-8D	31.25	30.75	32	279	314	257	60	IF32	Key14-16	M3X10	T10
E3200-D13/W08	32.00	MD-150-EA	WOMT080308--D33		31.25	30.75	32	279	314	257	60				
E3300-D16/W08	33.00	MD-160-EA	WOMT080308--D33		31.25	30.75	32	279	314	257	60				
E3320-D16/W08	33.20	MD-160-EA	WOMT080308--D33		31.25	30.75	32	279	314	257	60				
E3333-D16/W08	33.33	MD-160-EA	WOMT080308--D33	S34-32-8D	31.25	30.75	32	279	314	257	60	IF32	Key14-16	M3X10	T10
E3400-D16/W08	34.00	MD-160-EA	WOMT080308--D31		31.25	30.75	32	279	314	257	60				
E3493-D18/W08	34.93	MD-180-EA	WOMT080308--D33		31.25	30.75	32	279	314	257	60				
E3500-D18/W08	35.00	MD-180-EA	WOMT080308--D33		34.5	34	32	312	348	290	60				
E3600-D18/W08	36.00	MD-180-EA	WOMT080308--D33	S34-32-8D	34.5	34	32	312	348	290	60	IF32	Key17-20	M3X10	T10
E3653-D19/W08	36.53	MD-190-EA	WOMT080308--D33		34.5	34	32	312	348	290	60				
E3700-D16/W10	37.00	MD-160-EA	WOMT100308--D39		34.5	34	32	312	348	290	60				
E3730-D16/W10	37.50	MD-160-EA	WOMT100308--D39		34.5	34	32	312	348	290	60				
E3800-D16/W10	38.00	MD-160-EA	WOMT100308--D39	S37-32-8D	37.5	37	32	335	366	310	60	IF38	Key14-16	M3X10	T10
E3810-D16/W10	38.10	MD-160-EA	WOMT100308--D39		37.5	37	32	335	366	310	60				
E3900-D18/W10	39.00	MD-180-EA	WOMT100308--D39		37.5	37	32	335	366	310	60				
E3920-D18/W10	39.20	MD-180-EA	WOMT100308--D39		37.5	37	32	335	366	310	60				
E3970-D18/W10	39.70	MD-180-EA	WOMT100308--D39	S39-50-8D	37.5	37	32	335	366	310	60	IF38	Key17-20	M3X10	T10
E4000-D18/W10	40.00	MD-180-EA	WOMT100308--D39		39.5	39	50	345	395	320	70				
E4100-D19/W10	41.00	MD-190-EA	WOMT100308--D39		39.5	39	50	345	395	320	70				
E4128-D19/W10	41.28	MD-190-EA	WOMT100308--D39		39.5	39	50	345	395	320	70				
E4200-D19/W10	42.00	MD-190-EA	WOMT120408--D42	S41-50-8D	41.5	41	50	365	405	340	70	IF42	Key14-16	M4X12	T15
E4300-D16/W12	43.00	MD-160-EA	WOMT120408--D42		41.5	41	50	365	405	340	70				
E4400-D18/W12	44.00	MD-180-EA	WOMT120408--D42		41.5	41	50	365	405	340	70				
E4445-D18/W12	44.45	MD-180-EA	WOMT120408--D42		41.5	41	50	365	405	340	70				
E4500-D18/W12	45.00	MD-180-EA	WOMT120408--D42	S47-50-8D	44.5	44	50	390	435	364	70	IF42	Key17-20	M4X12	T15
E4600-D19/W12	46.00	MD-190-EA	WOMT120408--D42		44.5	44	50	390	435	364	70				
E4700-D20/W12	47.00	MD-200-EA	WOMT120408--D42		44.5	44	50	390	435	364	70				
E4763-D21/W12	47.63	MD-210-EA	WOMT120408--D42		44.5	44	50	390	435	364	70				
E4800-D21/W12	48.00	MD-210-EA	WOMT120408--D42	S47-50-8D	47.5	47	50	410	450	375	70	IF48	Key21-28	M4X12	T15
E4900-D22/W12	49.00	MD-220-EA	WOMT120408--D42		47.5	47	50	410	450	375	70				
E5000-D23/W12	50.00	MD-230-EA	WOMT120408--D42		47.5	47	50	410	450	375	70				
E5080-D24/W12	50.80	MD-240-EA	WOMT120408--D42		50.3	49.8	50	425	465	390	70				
E5100-D24/W12	51.00	MD-240-EA	WOMT120408--D42	S50-50-8D	50.3	49.8	50	425	465	390	70	IF48	Key21-28	M4X12	T15
E5200-D25/W12	52.00	MD-250-EA	WOMT120408--D42		50.3	49.8	50	425	465	390	70				
E5300-D25/W12	53.00	MD-260-EA	WOMT120408--D42		50.3	49.8	50	425	465	390	70				
E5398-D27/W12	53.98	MD-270-EA	WOMT120408--D42		53.4	53	50	440	480	405	70				
E5400-D27/W12	54.00	MD-270-EA	WOMT120408--D42	S53-50-8D	53.4	53	50	440	480	405	70	IF48	Key21-28	M4X12	T15
E5500-D28/W12	55.00	MD-280-EA	WOMT120408--D42		53.4	53	50	440	480	405	70				



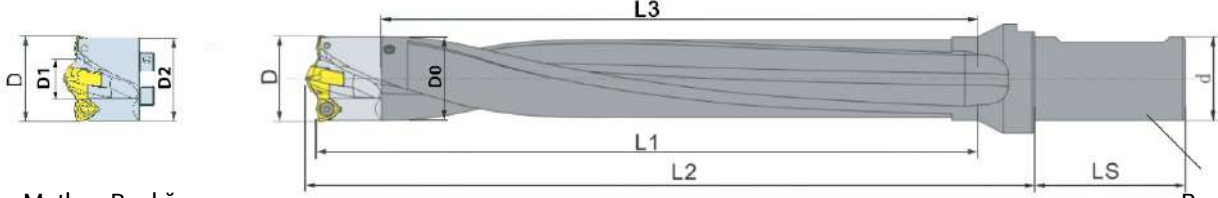

Matkap Başlığı  
Drill Head

Başlık Birimi  
Holder Unit

Kesici Birimi Cutting Unit	Matkap Çapı D Drill Dia D (mm)	Merkez Matkap Başlığı Çapı D1 Center Drill Head Dia D0	Yan Uç Side Inserts x1	Tutucu Birimi Holder Unit	Boyutlar Dimensions (mm)						Arayüzey Kodu Interface Code	Yedek Parça Spare Parts				
					D2	D0	d	L1	L2	L3		LS				
E2800-D14/A04	28,00	MD-140-EA	AOMT040308	S27-32-10D	27,5	27	32	245	285	225	60	IF28	Key14-16	M2.5X8	T9	
E2858-D15/A04	28,58	MD-150-EA	AOMT040308		27,5	27	32	245	285	225	60					
E2900-D16/A04	29,00	MD-160-EA	AOMT040308		27,5	27	32	245	285	225	60					
E2936-D16/A04	29,36	MD-160-EA	AOMT040308	S29-32-10D	29,5	29	32	250	288	230	60		Key17-20			
E3000-D16/A04	30,00	MD-160-EA	AOMT040308		29,5	29	32	250	288	230	60					
E3018-D17/A04	30,18	MD-170-EA	AOMT040308		29,5	29	32	250	288	230	60					
E3096-D17/A04	30,96	MD-170-EA	AOMT040308	S31-32-10D	29,5	29	32	250	288	230	60	IF32	Key14-16	M3X10	T10	
E3100-D17/A04	31,00	MD-170-EA	AOMT040308		31,25	30,75	32	279	314	257	60					
E3175-D15/W08	31,75	MD-150-EA	WOMT080308-...-D33		31,25	30,75	32	279	314	257	60					
E3200-D13/W08	32,00	MD-150-EA	WOMT080308-...-D33	S34-32-10D	31,25	30,75	32	279	314	257	60		Key17-20			
E3300-D16/W08	33,00	MD-160-EA	WOMT080308-...-D33		31,25	30,75	32	279	314	257	60					
E3320-D16/W08	33,20	MD-160-EA	WOMT080308-...-D33		31,25	30,75	32	279	314	257	60					
E3333-D16/W08	33,33	MD-160-EA	WOMT080308-...-D33	S37-32-10D	31,25	30,75	32	279	314	257	60	IF'8	Key14-16			
E3400-D16/W08	34,00	MD-160-EA	WOMT080308-...-D31		31,25	30,75	32	279	314	257	60					
E3493-D18/W08	34,93	MD-180-EA	WOMT080308-...-D33		31,25	30,75	32	279	314	257	60					
E3500-D18/W08	35,00	MD-180-EA	WOMT080308-...-D33	S39-50-10D	34,5	34	32	312	348	290	60		Key17-20			
E3600-D18/W08	36,00	MD-180-EA	WOMT080308-...-D33		34,5	34	32	312	348	290	60					
E3653-D19/W08	36,53	MD-190-EA	WOMT080308-...-D33		34,5	34	32	312	348	290	60					
E3700-D16/W10	37,00	MD-160-EA	WOMT100308-...-D39	S41-50-10D	34,5	34	32	312	348	290	60	IF42	Key14-16			
E3730-D16/W10	37,50	MD-160-EA	WOMT100308-...-D39		34,5	34	32	312	348	290	60					
E3800-D16/W10	38,00	MD-160-EA	WOMT100308-...-D39		37,5	37	32	335	366	310	60					
E3810-D16/W10	38,10	MD-160-EA	WOMT100308-...-D39	S47-50-10D	37,5	37	32	335	366	310	60		IF48	Key17-20	M4X12	T15
E3900-D18/W10	39,00	MD-180-EA	WOMT100308-...-D39		37,5	37	32	335	366	310	60					
E3920-D18/W10	39,20	MD-180-EA	WOMT100308-...-D39		37,5	37	32	335	366	310	60					
E3970-D18/W10	39,70	MD-180-EA	WOMT100308-...-D39	S47-50-10D	37,5	37	32	335	366	310	60	IF48		Key17-20		
E4000-D18/W10	40,00	MD-180-EA	WOMT100308-...-D39		39,5	39	50	345	395	320	70					
E4100-D19/W10	41,00	MD-190-EA	WOMT100308-...-D39		39,5	39	50	345	395	320	70					
E4128-D19/W10	41,28	MD-190-EA	WOMT100308-...-D39	S50-50-10D	39,5	39	50	345	395	320	70		Key21-28			
E4200-D19/W10	42,00	MD-190-EA	WOMT120408-...-D42		41,5	41	50	365	405	340	70					
E4300-D16/W12	43,00	MD-160-EA	WOMT120408-...-D42		41,5	41	50	365	405	340	70					
E4400-D18/W12	44,00	MD-180-EA	WOMT120408-...-D42	S53-50-10D	41,5	41	50	365	405	340	70	Key21-28				
E4445-D18/W12	44,45	MD-180-EA	WOMT120408-...-D42		41,5	41	50	365	405	340	70					
E4500-D18/W12	45,00	MD-180-EA	WOMT120408-...-D42		44,5	44	50	390	435	364	70					
E4600-D19/W12	46,00	MD-190-EA	WOMT120408-...-D42	S53-50-10D	44,5	44	50	390	435	364	70		Key21-28			
E4700-D20/W12	47,00	MD-200-EA	WOMT120408-...-D42		44,5	44	50	390	435	364	70					
E4763-D21/W12	47,63	MD-210-EA	WOMT120408-...-D42		44,5	44	50	390	435	364	70					
E4800-D21/W12	48,00	MD-210-EA	WOMT120408-...-D42	S53-50-10D	47,5	47	50	410	450	375	70	Key21-28				
E4900-D22/W12	49,00	MD-220-EA	WOMT120408-...-D42		47,5	47	50	410	450	375	70					
E5000-D23/W12	50,00	MD-230-EA	WOMT120408-...-D42		47,5	47	50	410	450	375	70					
E5080-D24/W12	50,80	MD-240-EA	WOMT120408-...-D42	S53-50-10D	50,3	49,8	50	425	465	390	70		Key21-28			
E5100-D24/W12	51,00	MD-240-EA	WOMT120408-...-D42		50,3	49,8	50	425	465	390	70					
E5200-D25/W12	52,00	MD-250-EA	WOMT120408-...-D42		50,3	49,8	50	425	465	390	70					
E5300-D26/W12	53,00	MD-260-EA	WOMT120408-...-D42	S53-50-10D	50,3	49,8	50	425	465	390	70	Key21-28				
E5398-D27/W12	53,98	MD-270-EA	WOMT120408-...-D42		53,4	53	50	440	480	405	70					
E5400-D27/W12	54,00	MD-270-EA	WOMT120408-...-D42		53,4	53	50	440	480	405	70					
E5500-D28/W12	55,00	MD-280-EA	WOMT120408-...-D42	53,4	53	50	440	480	405	70						

## RAPID DRILL

## RAPID DRILL

### Soğutma Delikli Çok Uçlu Kademeli Matkap Takımları Special Multi-Insert Step Drill Toolholders with Coolant

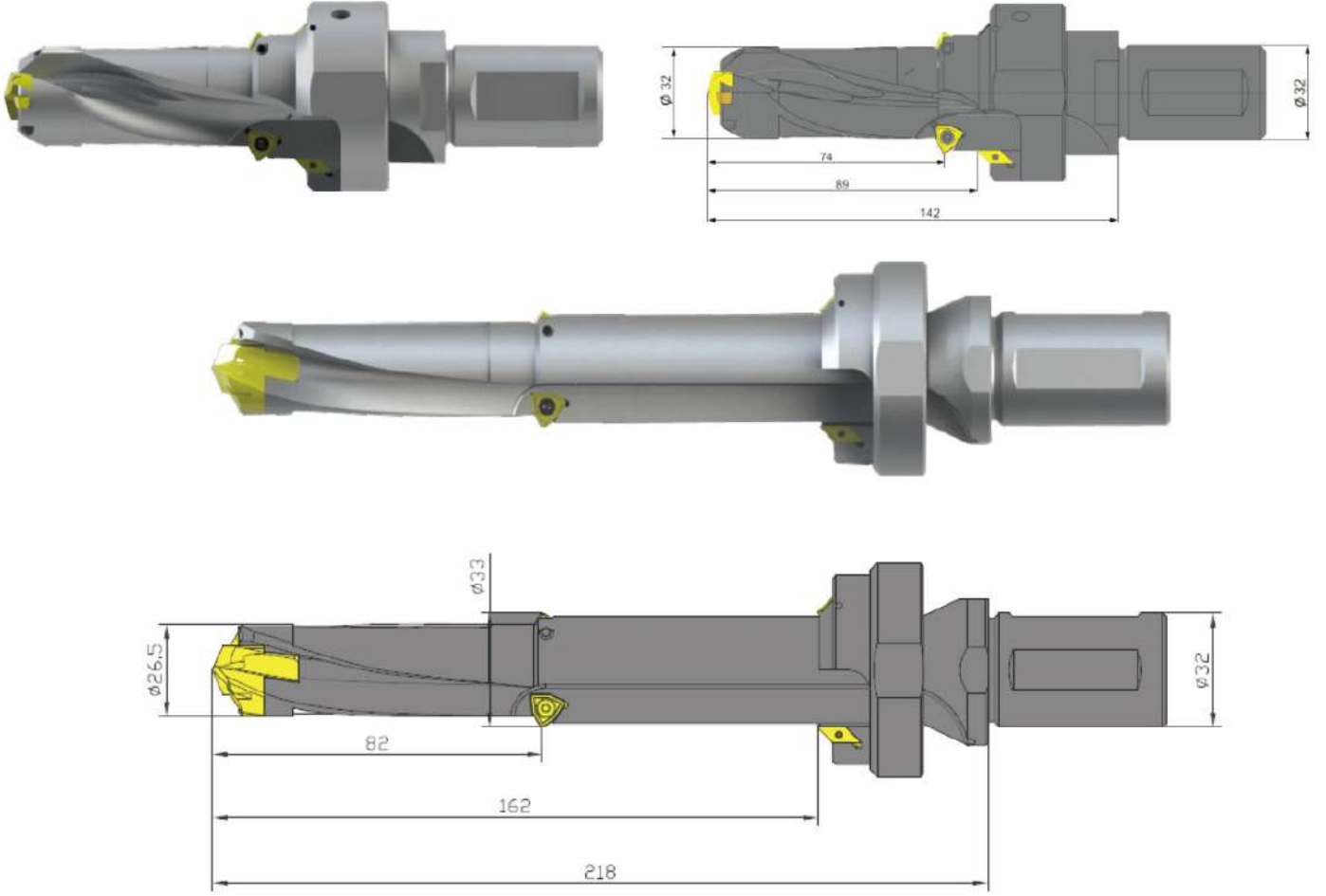

\*Euroloy müşterinin ihtiyaçlarına göre özel çok uçlu delme takımları tasarlar ve üretir.

\*Euroloy can design and produce special multi-insert drilling tools according to customer's requests.

ISO	Materyal Materials	Isı Tedavisi Heat Treatment	Çizim Kuvveti (Kn/mm <sup>2</sup> ) Drawing Force	Sertlik (HB) Hardness	Kesme Hızı Vc(m/min) Cutting Speed	Feed Rate (mm/rev)						
						D<10	D=10-11.9	D=12-13.9	D=14-15.9	D=16-19.9	D=20-25.9	
P	Alaşsız Çelik Unalloyed Steel	<0,25%C Tavlı / Annealed	420	125	80~140							
		>=0,25%C Tavlı / Annealed	650	190	80~130	0,12	0,15	0,18	0,20	0,25	0,25	
	Dökme Demir Cast Iron	<0,55%C	850	250	80~120	0,17	0,21	0,24	0,27	0,35	0,35	
		Tavlama Ve Temperleme Annealing And Tempering	750	220	70~110	0,22	0,28	0,30	0,35	0,45	0,45	
	Otomat Çeliği Free Cutting Steel	Tavlama ve Temperleme Annealing And Tempering	1000	300	50~90							
		Düşük Karbonlu Çelik Dökme Demir (Alaşım bileşimi <5%) Low Carbon Steel Cast Iron (Alloy composition<5%)	Tavlı / Annealed	600	200	70~120	0,12	0,14	0,16	0,18	0,23	0,25
	Yüksek Alaşımli Çelik, Dökme Demir High Alloy Steel, Cast Iron	tavlama ve temperleme annealing and tempering	930	275	70~110	0,18	0,21	0,24	0,26	0,31	0,35	
		annealing and tempering	1000	300	50~90	0,25	0,28	0,32	0,35	0,40	0,45	
	Tavlı / Annealed	680	200	50~90	0,12	0,12	0,15	0,18	0,20	0,22		
		Tavlama ve Temperleme Annealing And Tempering	110	325	40~80	0,16	0,17	0,20	0,23	0,25	0,27	
M	Paslanmaz Çelik Dökme Demir Stainless Steel Cast Iron	Ferritik / Martensit Ferritic / Martensite	680	200	40~70	0,20	0,22	0,25	0,28	0,30	0,33	
		Martensit / Martensite	820	240	40~70	0,10	0,12	0,14	0,16	0,16	0,18	
	Austenitik / Östenitik	600	180	30~70	0,12	0,15	0,17	0,20	0,21	0,24		
	K	Gri Dökme Demir Gray Cast Iron	Ferritik / Ferritic		160	90~160						
Perlitik / Pearlitic				250	80~140	0,15	0,18	0,20	0,24	0,26	0,30	
Nodüler SG Demir Nodular SG Iron		Ferritik / Ferritic		180	90~180	0,15	0,20	0,25	0,30	0,35	0,35	
		Perlitik / Pearlitic		260	80~140	0,22	0,27	0,32	0,37	0,45	0,37	
Dövülebilir Dökme Demir Malleable Cast Iron	Ferritik / Ferritic		130	90~160	0,30	0,35	0,40	0,45	0,55	0,60		
	Perlitik / Pearlitic		230	80~140								
N	Dökme Alüminyum Alaşım Cast Aluminium Alloy	Güçlendirme Yok Unsolidification		60	90~220							
		Güçlendirilmiş Solidification		100	90~220							
	<=12%Si	Güçlendirme Yok Unsolidification		75	90~220							
		Güçlendirilmiş Solidification		90	90~220	0,20	0,25	0,30	0,35	0,40	0,45	
	Dökme Alüminyum Alaşım Cast Aluminium Alloy	>12%Si	Yüksek Sıcaklık Tedavisi High Temperature Treatment		130	80~160	0,27	0,32	0,37	0,42	0,50	0,57
		>1%Pb Serbest Kesim / Free Cutting		110	90~220	0,35	0,40	0,45	0,50	0,60	0,70	
	Bakır Alaşımı Copper Alloy	Bakır / Copper		90	90~220							
Katot Bakır /Cathode Copper			100	90~220								
S	Yüksek sıcaklık Alaşım High Temperature Alloys	Demir Taban Iron-Base	Annealed / Tavlanmış		30~60							
		Güçlendirilmiş Solidification		200	20~50	0,06	0,08	0,10	0,12	0,12	0,14	
		Annealed / Tavlanmış		280	20~50	0,08	0,10	0,12	0,15	0,16	0,18	
		Nikel Bazlı Nickelbase	Güçlendirilmiş Solidification		250	20~50	0,11	0,13	0,15	0,18	0,20	0,22
	Kobalt Tabanı Cobalt Base	Döküm Cast		350	20~50	0,06	0,08	0,10	0,12	0,14	0,16	
		Solidification		250	20~50	0,09	0,11	0,14	0,16	0,18	0,20	
Titanyum, Titanyum Alaşım Titanium, Titanium Alloys		Rm400		320	20~50	0,12	0,15	0,18	0,20	0,22	0,25	
	$\alpha + \beta$	RM1050			20~50	0,06	0,08	0,10	0,12	0,14	0,16	
H	Sert Çelik Hard Steel	Sertlik Hardness		55HRC	20~50	0,09	0,11	0,14	0,16	0,18	0,20	
		Sertleşmek Harden		60HRC	20~50	0,12	0,15	0,18	0,20	0,22	0,25	

8D ve 12D takım tutucular için daha düşük kesme hızı ve ilerleme kullanılmalıdır.

Lower cutting speed and feed rate should be used for tool holders of 8D and 12D

Materyal Materials	Isı Tedavisi Heat Treatment	VC m/min		Metrik Sistem Metric System				
		min	max	(F mm/r)				
				28,00-31,74mm	31,75-35,99mm	36,00-44,99mm	45,00-55,00mm	
P	2	S	90	230	0,160-0,280	0,160-0,280	0,200-0,360	0,200-0,400
		U	70	170	0,160-0,280	0,160-0,280	0,200-0,360	0,200-0,400
		I	50	110	0,160-0,280	0,160-0,280	0,200-0,320	0,200-0,400
	3	S	90	230	0,160-0,280	0,160-0,280	0,200-0,320	0,200-0,400
		U	70	170	0,160-0,280	0,160-0,280	0,200-0,320	0,200-0,400
		I	50	106	0,160-0,280	0,160-0,280	0,200-0,320	0,200-0,400
	4	S	90	220	0,160-0,280	0,160-0,280	0,200-0,320	0,200-0,400
		U	70	160	0,160-0,280	0,160-0,280	0,200-0,320	0,200-0,400
		I	50	110	0,160-0,280	0,160-0,280	0,200-0,320	0,200-0,400
	5	S	90	210	0,160-0,280	0,160-0,280	0,200-0,320	0,200-0,400
		U	70	150	0,160-0,280	0,160-0,280	0,200-0,320	0,200-0,400
		I	50	100	0,160-0,280	0,160-0,280	0,200-0,320	0,200-0,400
6	S	90	180	0,160-0,280	0,160-0,280	0,200-0,320	0,200-0,400	
	U	75	120	0,160-0,280	0,160-0,280	0,200-0,320	0,200-0,400	
	I	60	100	0,160-0,280	0,160-0,280	0,200-0,320	0,200-0,400	
M	1	S	110	135	0,130-0,250	0,130-0,250	0,160-0,280	0,160-0,320
		U	70	90	0,130-0,250	0,130-0,250	0,160-0,280	0,160-0,320
		I	50	65	0,130-0,250	0,130-0,250	0,160-0,280	0,160-0,320
	2	S	100	135	0,130-0,250	0,130-0,250	0,160-0,280	0,160-0,320
		U	60	90	0,130-0,250	0,130-0,250	0,160-0,280	0,160-0,320
		I	50	65	0,130-0,250	0,130-0,250	0,160-0,280	0,160-0,320
	3	S	90	135	0,130-0,250	0,130-0,250	0,160-0,280	0,160-0,320
		U	60	90	0,130-0,250	0,130-0,250	0,160-0,280	0,160-0,320
		I	40	65	0,130-0,250	0,130-0,250	0,160-0,280	0,160-0,320
K	1	S	170	230	0,180-0,300	0,180-0,300	0,216-0,360	0,240-0,420
		U	120	160	0,180-0,300	0,180-0,300	0,216-0,360	0,240-0,420
		I	70	90	0,180-0,300	0,180-0,300	0,216-0,360	0,240-0,420
	2	S	160	220	0,180-0,300	0,180-0,300	0,216-0,360	0,240-0,420
		U	110	160	0,180-0,300	0,180-0,300	0,216-0,360	0,240-0,420
		I	70	100	0,180-0,300	0,180-0,300	0,216-0,360	0,240-0,420
	3	S	150	210	0,180-0,300	0,180-0,300	0,216-0,360	0,240-0,420
		U	100	150	0,180-0,300	0,180-0,300	0,216-0,360	0,240-0,420
		I	660	90	0,180-0,300	0,180-0,300	0,216-0,360	0,240-0,420
N	1	S	240	360	0,120-0,200	0,120-0,200	0,144-0,280	0,160-0,320
		U	160	240	0,120-0,200	0,120-0,200	0,144-0,280	0,160-0,320
		I	100	160	0,120-0,200	0,120-0,200	0,144-0,280	0,160-0,320
	2	S	220	360	0,120-0,200	0,120-0,200	0,144-0,280	0,160-0,320
		U	150	240	0,120-0,200	0,120-0,200	0,144-0,280	0,160-0,320
		I	100	160	0,120-0,200	0,120-0,200	0,144-0,280	0,160-0,320
	3	S	200	360	0,120-0,200	0,120-0,200	0,144-0,280	0,160-0,320
		U	140	240	0,120-0,200	0,120-0,200	0,144-0,280	0,160-0,320
		I	90	160	0,120-0,200	0,120-0,200	0,144-0,280	0,160-0,320
	4	S	220	260	0,120-0,200	0,120-0,200	0,144-0,280	0,160-0,320
		U	140	170	0,120-0,200	0,120-0,200	0,144-0,280	0,160-0,320
		I	90	110	0,120-0,200	0,120-0,200	0,144-0,280	0,160-0,320



**[www.euroloy.com](http://www.euroloy.com)**

**Head Office - Via Leonardo Da Vinci, 4  
- 20054, Segrate  
Milano MI ITALIA**

**Euroloy Italia (+39) 0282398309  
Euroloy Turkey (+90) 850 933 3408**

**✉ [info@euroloy.com](mailto:info@euroloy.com)**

**📷 [@euroloytools](https://www.instagram.com/euroloytools)**