

# DELİK İŞLEME

## DRILLING

2026 | CATALOG

[www.euroloy.com](http://www.euroloy.com)

 **EURLOY**  
CARBIDE TOOLS

# içindekiler

## TABLE OF CONTENTS

Delik Delme Kodlama Sistemi Drilling Insert Coding System	E3
U-Drill Takımlar U-Drill Tools	E4-E18
Pro Drill Takımlar Pro Drill Tools	E20-E23
Tiger Drill Takımlar Tiger Drill Tools	E24-E32
Speed Turn Takımlar Speed Turn Holders	E33
Rapid Drill Kodlama Sistemi Drilling Insert Coding System	E34
Rapid Drill Teknik Bilgiler Rapid Drill Technical Information	E34-E39
Takım Tutucular Tool Holders	E79-E91
Çoklu Uç Teknik Bilgi Multi Insert Technical Information	E79-E91







## DELİK DELME KODLAMA SİSTEMİ

### DRILLING TOOL CODING SYSTEM

1	2	3	4	5	6	7		
D	3	G	-	25	32	-	SPX0	09
Delik Delme Drilling	İşleme Boyu Work Length 2D-3D-4D-5D	Uç Modeli Insert Model	Matkap Çapı Drill Diameter ø12,5-50	Şaft Çapı Shaft Diameter	Uç Kodu Insert Code	Uç Ölçüsü Insert Dimensions		

## DELİK DELME TAKIM ÖZETİ

### DRILLING TOOL SUMMARY

Seri Series	Uç Insert	Şekil Shape	Matkap Çapı Drill Diameter	İşleme Boyu Work Length	Sayfa Page
U-DRILL	SPMG/SPGT...		ø12,5 - ø50	2D - 5D	6-11
	WCMX/WCKT...		ø16 - ø50	2D - 5D	12-17
PRO-DRILL	XOMT/SPMT...		ø16 - ø35	2D - 5D	21-23
TIGER DRILL	SOMT...		ø13 - ø50	2D - 5D	23-30
SPEED TURN	XCMT...		ø10 - ø20	2D - 5D	33
RAPID DRILL	ED...		ø7,8 - ø55	1.5D - 12D	40-89

## DEĞİŞTİRİLEBİLİR KARBÜR UÇ VE TAKIMLAR

### INDEXABLE DRILLS AND INSERTS

## SPMG

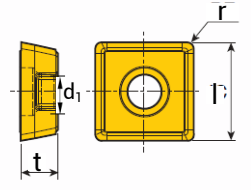

Ürün Görseli Product Image	CB	Uç Kodu Insert Code	U						K				S				Ölçüler - Dimensions			
			TP1630	TP2625	TP3630	TP4630	TP5620	TC2215	TP4420											
	DG	SPMG 050204	○			●	●	○	○	5	2.38	0.4	2.25							
		SPMG 060204	●			●	○	○	●	6.35	2.38	0.4	2.60							
		SPMG 07T308	●			●	●	○	●	7.95	3.97	0.8	2.80							
		SPMG 090408	●			●	○	○	●	9.525	4.76	0.8	4.0							
		SPMG 110408	●			●	○	○	●	11.10	4.76	0.8	4.40							
		SPMG 140512	●			●	○	○	○	14.29	4.76	1.2	5.76							

## SPGT

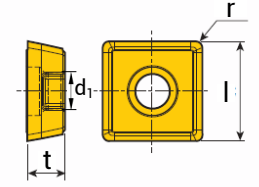

Ürün Görseli Product Image	CB	Uç Kodu Insert Code	N						Ölçüler - Dimensions				
			TN7501						l	d	t	r	d1
	AL	SPGT 050204	●						5	-	2.38	0.4	2.25
		SPGT 060204	●						6.35	-	2.38	0.4	2.60
		SPGT 07T308	●						7.95	-	3.97	0.8	2.80
		SPGT 090408	●						9.525	-	4.76	0.8	4.0
		SPGT 110408	●						11.10	-	4.76	0.8	4.40
		SPGT 140512	●						14.29	-	4.76	1.2	5.76

## 2D U-DRILL TAKIMLAR / 2D U-DRILL TOOLS

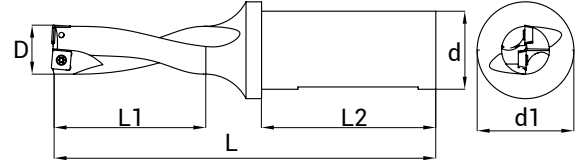

(mm)

Takım Kodu Order Code	Stok Durumu Stock Availability	D	d	d1	L	L1	L2	Uç Insert	Vida Screw	Anahtar Torx Key
D2T-12520-SP05	●	12,5	20	25	94	25	50	SPMG/SPGT 050204	M2X5	
D2T-1320-SP05	●	13	20	25	94	26	50			
D2T13520-SP05	●	13,5	20	25	94	27	50			
D2T-1420-SP05	●	14	20	25	97	28	50			
D2T-14520-SP05	●	14,5	20	25	100	29	50			
D2T-1520-SP05	●	15	20	25	100	30	50			
D2T-15525-SP05	●	15,5	25	34	110	31	56			
D2T-1625-SP06	●	16	25	34	110	32	56	SPMG/SPGT 060204	SM2,2X5	T06
D2T-16525-SP06	●	16,5	25	34	112	33	56			
D2T-1725-SP06	●	17	25	34	112	34	56			
D2T-17525-SP06	●	17,5	25	34	112	34	56			
D2T-1825-SP06	●	18	25	34	114	36	56			
D2T-18525-SP06	●	18,5	25	34	116	37	56			
D2T-1925-SP06	●	19	25	34	116	38	56			
D2T-19525-SP06	●	19,5	25	34	119	39	56			
D2T-2025-SP06	●	20	25	34	119	40	56			
D2T-20525-SP06	●	20,5	25	34	122	41	56			
D2T-2125-SP06	●	21	25	34	122	42	56	SPMG/SPGT 071308	SM2,5X7	T08
D2T21525-SP06	●	21,5	25	34	125	43	56			
D2T-2225-SP07	●	22	25	34	125	43	56			
D2T-22525-SP07	●	22,5	25	34	128	45	56			
D2T-2325-SP07	●	23	25	34	128	46	56			
D2T-23525-SP07	●	23,5	25	34	129	47	56			
D2T-2425-SP07	●	24	25	34	129	48	56			
D2T-24525-SP07	●	24,5	25	34	131	49	56			
D2T-2525-SP07	●	25	25	34	131	50	56			
D2T-25525-SP07	●	25,5	25	34	134	51	56			
D2T-2625-SP07	●	26	25	34	134	52	56	SPMG/SPGT 090408	SM3,5X8	
D2T-26525-SP07	●	26,5	25	34	136	53	56			
D2T-2725-SP07	●	27	25	34	137	54	56			
D2T-27525-SP09	●	27,5	25	34	140	55	56			
D2T-2825-SP09	●	28	25	34	140	56	56			
D2T-28525-SP09	●	28,5	25	34	143	58	56			
D2T-2925-SP09	●	29	25	34	143	58	56			
D2T-29525-SP09	●	29,5	25	34	143	59	56			
D2T-3032-SP09	●	30	32	44	150	60	60			
D2T-3132-SP09	●	31	32	44	153	62	60			

● Stok ürün - Stock item

○ Stok dışı ürün - Non Stock item

△ Özel Sipariş - Special order

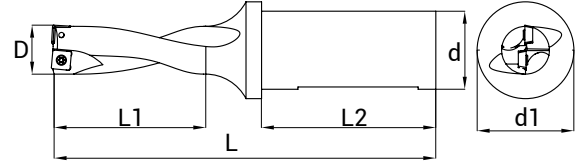
2D U-DRILL TAKIMLAR / **2D** U-DRILL TOOLS

(mm)

Takım Kodu Order Code	Stok Durumu Stock Availability	D	d	d1	L	L1	L2	Uç Insert	Vida Screw	Anahtar Torx Key
D2T-3232-SP09	●	32	32	44	156	64	60	SPMG/SPGT 110408	SM4X11	T15
D2T-3332-SP09	●	33	32	44	159	66	60			
D2T-3432-SP11	●	34	32	44	162	68	60			
D2T-3532-SP11	●	35	32	44	165	70	60			
D2T-3632-SP11	●	36	32	44	168	72	60			
D2T-3732-SP11	●	37	32	44	171	74	60			
D2T-3832-SP11	●	38	32	44	174	76	60			
D2T-3932-SP11	●	39	32	44	177	78	60			
D2T-4032-SP11	●	40	32	44	180	80	60			
D2T-4132-SP11	●	41	32	44	183	82	60			
D2T-4232-SP14	●	42	32	44	186	84	60	SPMG/SPGT 140512	M5X12	T20
D2T-42532-SP14	●	42,5	32	44	189	86	60			
D2T-4332-SP14	●	43	32	44	189	86	60			
D2T-4432-SP14	●	44	32	44	192	88	60			
D2T-4540-SP14	●	45	40	54	195	90	70			
D2T-4640-SP14	●	46	40	54	198	92	70			
D2T-4740-SP14	●	47	40	54	201	94	70			
D2T-4840-SP14	●	48	40	54	204	96	70			
D2T-4940-SP14	●	49	40	54	207	98	70			
D2T-5040-SP14	●	50	40	54	210	100	70			

## 3D U-DRILL TAKIMLAR / 3D U-DRILL TOOLS

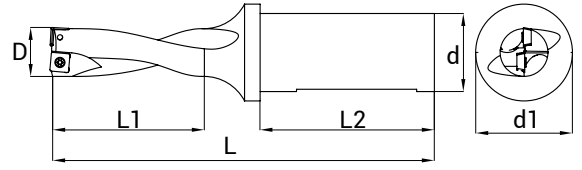

(mm)

Takım Kodu Order Code	Stok Durumu Stock Availability	D	d	d1	L	L1	L2	Uç Insert	Vida Screw	Anahtar Torx Key
D3T-12520-SP05	●	12,5	20	25	101	37,5	50	SPMG/SPGT 050204	SM2x5	
D3T-1320-SP05	●	13	20	25	101	39	50			
D3T-13520-SP05	●	13,5	20	25	105	40,5	50			
D3T-1420-SP05	●	14	20	25	105	42	50			
D3T-14520-SP05	●	14,5	20	25	109	45	50			
D3T-1520-SP05	●	15	20	25	109	45	50			
D3T-15520-SP05	●	15,5	20	34	126	48	50			
D3T-1625-SP06	●	16	25	34	126	48	56	SPMG/SPGT 060204	SM2,2x5	T06
D3T-16525-SP06	●	16,5	25	34	129	49,5	56			
D3T-1725-SP06	●	17	25	34	129	51	56			
D3T-17525-SP06	●	17,5	25	34	132	52,5	56			
D3T-1825-SP06	●	18	25	34	132	54	56			
D3T-18525-SP06	●	18,5	25	34	135	55,5	56			
D3T-1925-SP06	●	19	25	34	135	57	56			
D3T-19525-SP06	●	19,5	25	34	139	58,5	56			
D3T-2025-SP06	●	20	25	34	139	60	56			
D3T-20525-SP06	●	20,5	25	34	143	61,5	56			
D3T-2125-SP06	●	21	25	34	143	63	56	SPMG/SPGT 07T308	SM2,5x7	T08
D3T-21525-SP06	●	21,5	25	34	147	64,5	56			
D3T-2225-SP07	●	22	25	34	147	66	56			
D3T-22525-SP07	●	22,5	25	34	151	67,5	56			
D3T-2325-SP07	●	23	25	34	151	69	56			
D3T-23525-SP07	●	23,5	25	34	153	70,5	56			
D3T-2425-SP07	●	24	25	34	153	72	56			
D3T-24525-SP07	●	24,5	25	34	156	73,5	56			
D3T-2525-SP07	●	25	25	34	156	75	56			
D3T-25525-SP07	●	25,5	25	34	160	76,5	56			
D3T-2625-SP07	●	26	25	34	160	78	56			
D3T-26525-SP07	●	26,5	25	34	164	79,5	56			
D3T-2725-SP07	●	27	25	34	164	81	56			
D3T-27525-SP07	●	27,5	25	34	168	82,5	56			

● Stok ürün - Stock item

○ Stok dışı ürün - Non Stock item

△ Özel Sipariş - Special order

## 3D U-DRILL TAKIMLAR / 3D U-DRILL TOOLS

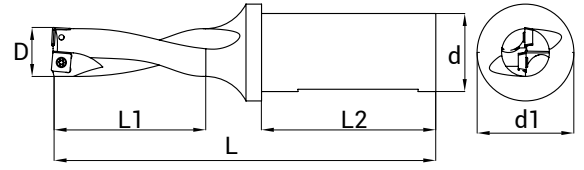

(mm)

Takım Kodu Order Code	Stok Durumu Stock Availability	D	d	d1	L	L1	L2	Uç Insert	Vida Screw	Anahtar Torx Key
D3T-2825-SP09	●	28	25	34	168	84	56	SPMG/SPGT 090408	SM3,5X8	
D3T-28525-SP09	●	28,5	25	34	172	85,5	56			
D3T-2925-SP09	●	29	25	34	172	87	56			
D3T-29525-SP09	●	29,5	25	44	180	88,5	56			
D3T-3032-SP09	●	30	32	44	180	90	60			
D3T-3132-SP09	●	31	32	44	184	93	60			
D3T-3232-SP09	●	32	32	44	188	96	60			
D3T-3332-SP09	●	33	32	44	192	99	60			
D3T-3432-SP11	●	34	32	44	192	102	60	SPMG/SPGT 110408	M4X11	T15
D3T-3532-SP11	●	35	32	44	200	105	60			
D3T-3632-SP11	●	36	32	44	204	108	60			
D3T-3732-SP11	●	37	32	44	208	111	60			
D3T-3832-SP11	●	38	32	44	212	114	60			
D3T-38532-SP11	●	38,5	32	44	216	115,5	60			
D3T-3932-SP11	●	39	32	44	216	117	60			
D3T-4032-SP11	●	40	32	44	220	120	60			
D3T-4132-SP11	●	41	32	44	223	123	60	SPMG/SPGT 140512	M5X12	T20
D3T-41532-SP11	●	41,5	32	44	226	124,5	60			
D3T-4232-SP14	●	42	32	44	226	126	60			
D3T-4332-SP14	●	43	32	44	229	129	60			
D3T-4432-SP14	●	44	32	44	232	132	60			
D3T-4540-SP14	●	45	40	54	245	135	70			
D3T-4640-SP14	●	46	40	54	248	138	70			
D3T-4740-SP14	●	47	40	54	251	141	70			
D3T-4840-SP14	●	48	40	54	254	144	70			
D3T-4940-SP14	●	49	40	54	257	147	70			
D3T-5040-SP14	●	50	40	54	260	150	70			

● Stok ürün - Stock item

○ Stok dışı ürün - Non Stock item

▲ Özel Sipariş - Special order

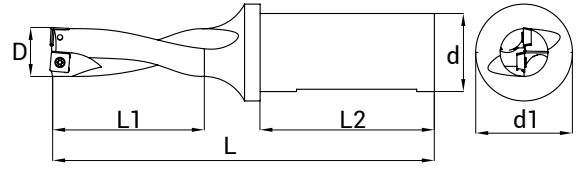
4D U-DRILL TAKIMLAR / **4D** U-DRILL TOOLS

(mm)

Takim Kodu Order Code	Stok Durumu Stock Availability	D	d	d1	L	L1	L2	Uç Insert	Vida Screw	Anahtar Torx Key
D4T-1320-SP05	●	13	20	25	115	52	50	SPMG/SPGT 050204	SM2X5	
D4T-1420-SP05	●	14	20	25	119	56	50			
D4T-14520-SP05	●	14,5	20	25	124	60	50			
D4T-1520-SP05	●	15	20	25	124	60	50			
D4T-15520-SP05	●	15,5	20	25	128	62	50			
D4T-1620-SP06	●	16	25	34	142	64	56	SPMG/SPGT 060204	SM2,2x5	T06
D4T-1725-SP06	●	17	25	34	146	68	56			
D4T-17525-SP06	●	17,5	25	34	150	52,5	56			
D4T-1825-SP06	●	18	25	34	150	72	56			
D4T-1925-SP06	●	19	25	34	154	76	56			
D4T-19525-SP06	●	19,5	25	34	159	78	56			
D4T-2025-SP06	●	20	25	34	159	80	56			
D4T-2125-SP06	●	21	25	34	164	84	56			
D4T-2225-SP07	●	22	25	34	169	88	56			
D4T-2325-SP07	●	23	25	34	174	92	56			
D4T-23525-SP07	●	23,5	25	34	174	92	56	SPMG/SPGT 07T308	SM2,5x7	T08
D4T-2425-SP07	●	24	25	34	177	96	56			
D4T-24525-SP07	●	24,5	25	34	181	100	56			
D4T-2525-SP07	●	25	25	34	181	100	56			
D4T-2625-SP07	●	26	25	34	186	104	56			
D4T-2725-SP07	●	27	25	34	191	108	56			
D4T-27525-SP07	●	27,5	25	34	191	112	56			
D4T-2825-SP09	●	28	25	34	196	112	56			
D4T-2925-SP09	●	29	25	34	201	116	56	SPMG/SPGT 090408	SM3,5x8	T15
D4T-3032-SP09	●	30	32	44	210	120	60			
D4T-3132-SP09	●	31	32	44	215	124	60			
D4T-3232-SP09	●	32	32	44	220	128	60			
D4T-3332-SP09	●	33	32	44	225	132	60			
D4T-33532-SP09	●	33,5	32	44	225	136	60			
D4T-3432-SP11	●	34	32	44	230	136	60			
D4T-3532-SP11	●	35	32	44	235	140	60			
D4T-3632-SP11	●	36	32	44	238	144	60			
D4T-3732-SP11	●	37	32	44	241	148	60			
D4T-3832-SP11	●	38	32	44	244	152	60			

● Stok ürün - Stock item

○ Stok dışı ürün - Non Stock item

△ Özel Sipariş - Special order

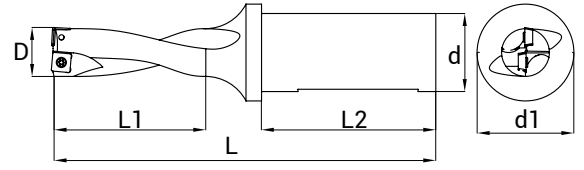
4D U-DRILL TAKIMLAR / **4D** U-DRILL TOOLS

(mm)

Takim Kodu Order Code	Stok Durumu Stock Availability	D	d	d1	L	L1	L2	Uç Insert	Vida Screw	Anahtar Torx Key
D4T-38532-SP11	●	38,5	32	44	247	156	60	SPMG/SPGT 110408	SM4X11	T15
D4T-3932-SP11	●	39	32	44	247	156	60			
D4T-39532-SP11	●	39,5	32	44	250	158	60			
D4T-4032-SP11	●	40	32	44	250	160	60			
D4T-4132-SP11	●	41	32	44	253	164	60			
D4T-4232-SP14	●	42	32	44	256	168	60	SPMG/SPGT 140512	M5X12	T20
D4T-4332-SP14	●	43	32	44	259	172	60			
D4T-4432-SP14	●	44	32	44	262	176	60			
D4T-4540-SP14	●	45	40	54	265	180	70			
D4T-4640-SP14	●	46	40	54	268	184	70			
D4T-4740-SP14	●	47	40	54	271	188	70			
D4T-4840-SP14	●	48	40	54	274	192	70			
D4T-4940-SP14	●	49	40	54	277	196	70			
D4T-5040-SP14	●	50	40	54	280	200	70			

 5D U-DRILL TAKIMLAR / **5D** U-DRILL TOOLS

(mm)

Takim Kodu Order Code	Stok Durumu Stock Availability	D	d	d1	L	L1	L2	Uç Insert	Vida Screw	Anahtar Torx Key
D5T-1625-SP06	●	16	25	34	153	80	56	SPMG/SPGT 060204	SM2,2x5	T06
D5T-1725-SP06	●	17	25	34	158	85	56			
D5T-1825-SP06	●	18	25	34	163	90	56			
D5T-1925-SP06	●	19	25	34	168	95	56			
D5T-2025-SP06	●	20	25	34	174	100	56			
D5T-2125-SP06	●	21	25	34	180	105	56	SPMG/SPGT 071308	SM2,5x7	T08
D5T-2225-SP07	●	22	25	34	186	110	56			
D5T-2325-SP07	●	23	25	34	192	115	56			
D5T-2425-SP07	●	24	25	34	196	120	56			
D5T-2525-SP07	●	25	25	34	200	125	56			
D5T-2625-SP07	●	26	25	34	206	130	56			
D5T-2725-SP07	●	27	25	34	212	135	56	SPMG/SPGT 090408	SM3,5x8	T15
D5T-2825-SP09	●	28	25	34	218	140	56			
D5T-2925-SP09	●	29	25	34	224	145	56			
D5T-3032-SP09	●	30	32	44	233	150	60			

● Stok ürün - Stock item

○ Stok dışı ürün - Non Stock item

▲ Özel Sipariş - Special order

## DEĞİŞTİRİLEBİLİR KARBÜR UÇ VE TAKIMLAR

### INDEXABLE DRILLS AND INSERTS

## WCMX

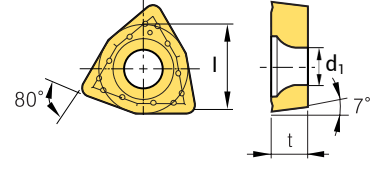

Ürün Görseli Product Image	CB	Uç Kodu Insert Code	U		K	S	Ölçüler- Dimensions			
			TP1630	TP2625	TP3630	TP4630	TP5620	TC2215	TP4420	l
	EN	WCMX 030204R	●	●	○	●	5.56	2.80	2.38	0.4
		WCMX 030208R	●	●	○	●	5.56	2.80	2.38	0.8
		WCMX 040204R	●	●	○	○	6.35	3.10	2.38	0.4
		WCMX 040208R	●	●	○	●	6.35	3.10	2.38	0.8
		WCMX 050308R	●	●	○	●	7.94	3.20	3.38	0.8
		WCMX 06T308R	●	●	○	○	9.52	3.70	4.17	0.8
		WCMX 080412R	○	●	○	●	12.70	4.30	4.96	1.2

## WCKT

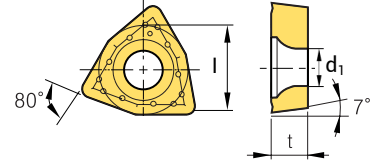

Ürün Görseli Product Image	CB	Uç Kodu Insert Code	N	Ölçüler- Dimensions			
			TN7501	l	d1	t	r
	DA	WCKT 030208	●	5.56	2.80	2.38	0.8
		WCKT 040208	●	6.35	3.0	2.38	0.8
		WCKT 050308	●	7.95	3.40	3.18	0.8
		WCKT 06T308	●	9.52	3.70	3.97	0.8
		WCKT 080412	●	8.70	4.30	4.76	0.8

● Stok ürün - Stock item

○ Stok dışı ürün - Non Stock item

△ Özel Sipariş - Special order

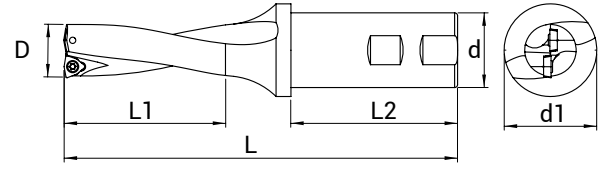
2D U-DRILL TAKIMLAR / **2D** U-DRILL TOOLS

(mm)

Takim Kodu Order Code	Stok Durumu Stock Availability	D	d	d1	L	L1	L2	Uç Insert	Vida Screw	Anahtar Torx Key
D2G-1625-WC03	●	16	25	34	110	32	50	WCMX / WCKT 0302	SM2,5X6	T08
D2G-16525-WC03	●	16,5	25	34	112	33	56			
D2G-1725-WC03	●	17	25	34	112	34	56			
D2G-17525-WC03	●	17,5	25	34	114	35	56			
D2G-1825-WC03	●	18	25	34	114	36	56			
D2G-18525-WC03	●	18,5	25	34	116	37	56			
D2G-1925-WC03	●	19	25	34	116	38	56			
D2G-19525-WC03	●	19,5	25	34	119	39	56			
D2G-2025-WC04	●	20	25	34	119	40	56	WCMX / WCKT 0402	M2,5X7	T08
D2G-20525-WC04	●	20,5	25	34	122	41	56			
D2G-2125-WC04	●	21	25	34	122	42	56			
D2G-2125-WC04	●	21	25	34	125	43	56			
D2G-2225-WC04	●	22	25	34	125	44	56			
D2G-22525-WC04	●	22,5	25	34	128	45	56			
D2G-2325-WC04	●	23	25	34	128	46	56			
D2G-23525-WC04	●	23,5	25	34	129	47	56			
D2G-2425-WC05	●	24	25	34	129	48	56	WCMX / WCKT 0503	M3X8	T10
D2G-24525-WC05	●	24,5	25	34	131	49	56			
D2G-2525-WC05	●	25	25	34	131	50	56			
D2G-25525-WC05	●	25,5	25	34	134	53	56			
D2G-2625-WC05	●	26	25	34	134	52	56			
D2G-26525-WC05	●	26,5	25	34	137	53	56			
D2G-2725-WC05	●	27	25	34	137	54	56			
D2G-27525-WC05	●	27,5	25	34	140	55	56			
D2G-2825-WC05	●	28	25	34	140	56	56	WCMX / WCKT 06T3	M3,5X11X4,8	T15
D2G-28525-WC05	●	28,5	25	34	140	57	56			
D2G-2925-WC05	●	29	25	34	143	58	56			
D2G-3032-WC06	●	30	32	44	150	60	60			
D2G-3132-WC06	●	31	32	44	153	62	60			
D2G-3232-WC06	●	32	32	44	156	64	60			
D2G-3332-WC06	●	33	32	44	159	66	60			
D2G-3432-WC06	●	34	32	44	162	68	60			
D2G-3532-WC06	●	35	32	44	165	70	60	WCMX / WCKT 06T3	M3,5X11X4,8	T15
D2G-3632-WC06	●	36	32	44	168	72	60			
D2G-3732-WC06	●	37	32	44	171	74	60			
D2G-3832-WC06	●	38	32	44	174	76	60			

● Stok ürün - Stock item

○ Stok dışı ürün - Non Stock item

▲ Özel Sipariş - Special order

## 2D U-DRILL TAKIMLAR / 2D U-DRILL TOOLS

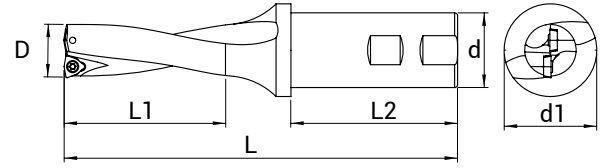

(mm)

Takım Kodu Order Code	Stok Durumu Stock Availability	D	d	d1	L	L1	L2	Uç Insert	Vida Screw	Anahtar Torx Key
D2G-3932-WC06	●	39	32	44	177	68	60	WCMX / WCKT 06T3	M3,5X11X4,8	T15
D2G-4032-WC06	●	40	32	44	180	80	60			
D2G-4132-WC06	●	41	32	44	183	82	60			
D2G-4232-WC06	●	42	32	44	186	84	60			
D2G-4332-WC06	●	43	32	44	189	86	60			
D2G-4432-WC06	●	44	32	44	192	88	60			
D2G-4540-WC08	●	45	40	54	195	90	70	WCMX / WCKT 0804	SM4X11	T15
D2G-4640-WC08	●	46	40	54	198	92	70			
D2G-4740-WC08	●	47	40	54	201	94	70			
D2G-4840-WC08	●	48	40	54	204	96	70			
D2G-4940-WC08	●	49	40	54	207	98	70			
D2G-5040-WC08	●	50	40	54	210	100	70			

## 3D U-DRILL TAKIMLAR / 3D U-DRILL TOOLS

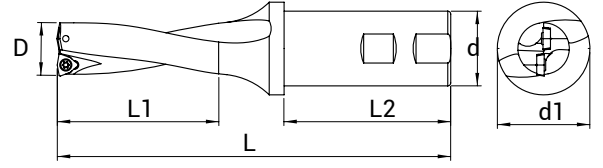

(mm)

Takim Kodu Order Code	Stok Durumu Stock Availability	D	d	d1	L	L1	L2	Uç Insert	Vida Screw	Anahtar Torx Key
D3G-15525-WC03	●	15,5	25	34	126	46,5	56	WCMX / WCKT 0302	SM2,5X6	T08
D3G-1625-WC03	●	16	25	34	126	48	56			
D3G-16525-WC03	●	16,5	25	34	129	49,5	56			
D3G-1725-WC03	●	17	25	34	129	51	56			
D3G-17525-WC03	●	17,5	25	34	132	52,5	56			
D3G-1825-WC03	●	18	25	34	132	54	56			
D3G-18525-WC03	●	18,5	25	34	135	55,5	56			
D3G-1925-WC03	●	19	25	34	135	57	56			
D3G-19525-WC03	●	19,5	25	34	139	58,5	56			
D3G-2025-WC04	●	20	25	34	139	60	56	WCMX / WCKT 0402	SM2,5X7	T08
D3G-20525-WC04	●	20,5	25	34	143	61,5	56			
D3G-2125-WC04	●	21	25	34	143	63	56			
D3G-21525-WC04	●	21,5	25	34	147	64,5	56			
D3G-2225-WC04	●	22	25	34	147	66	56			
D3G-22525-WC04	●	22,5	25	34	151	67,5	56			
D3G-2325-WC04	●	23	25	34	151	69	56			
D3G-23525-WC04	●	23,5	25	34	153	70,5	56			
D3G-2425-WC05	●	24	25	34	153	72	56			
D3G-24525-WC05	●	24,5	25	34	156	73,5	56			
D3G-2525-WC05	●	25	25	34	156	75	56			
D3G-25525-WC05	●	25,5	25	34	160	76,5	56			
D3G-2625-WC05	●	26	25	34	160	78	56			
D3G-26525-WC05	●	26,5	25	34	164	79,5	56			
D3G-2725-WC05	●	27	25	34	164	81	56			
D3G-27525-WC05	●	27,5	25	34	168	82,5	56			
D3G-2825-WC05	●	28	25	34	168	84	56			
D3G-28525-WC05	●	28,5	25	34	172	85,5	56	WCMX / WCKT 06T3	SM3,5X11X4,8	T15
D3G-2925-WC05	●	29	25	34	172	87	56			
D3G-29525-WC05	●	29,5	25	34	172	88,5	56			
D3G-3032-WC06	●	30	25	34	180	90	56			
D3G-3132-WC06	●	31	32	44	184	93	60			
D3G-31532-WC06	●	31,5	32	44	188	94,5	60			
D3G-3232-WC06	●	32	32	44	188	96	60			
D3G-32532-WC06	●	32,5	32	44	192	97,5	60			
D3G-3332-WC06	●	33	32	44	192	99	60			
D3G-33532-WC06	●	33,5	32	44	192	100,5	60			

● Stok ürün - Stock item

○ Stok dışı ürün - Non Stock item

▲ Özel Sipariş - Special order

### 3D U-DRILL TAKIMLAR / 3D U-DRILL TOOLS

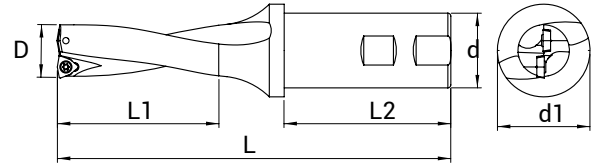

(mm)

Takim Kodu Order Code	Stok Durumu Stock Availability	D	d	d1	L	L1	L2	Uç Insert	Vida Screw	Anahtar Torx Key		
D3G-3432-WC06	●	34	32	44	192	102	60	WCMX / WCKT 06T3	SM3,5X11X4,8	T15		
D3G-34532-WC06	●	34,5	32	44	200	103,5	60					
D3G-3532-WC06	●	35	32	44	200	105	60					
D3G-35532-WC06	●	35,5	32	44	204	106,5	60					
D3G-3632-WC06	●	36	32	44	204	108	60					
D3G-36532-WC06	●	36,5	32	44	208	109,5	60					
D3G-3732-WC06	●	37	32	44	208	111	60					
D3G-37532-WC06	●	37,5	32	44	121	112,5	60					
D3G-3832-WC06	●	38	32	44	212	114	60					
D3G-38532-WC06	●	38,5	32	44	216	115,5	60					
D3G-3932-WC06	●	39	32	44	216	117	60					
D3G-39532-WC06	●	39,5	32	44	220	118,5	60					
D3G-4032-WC06	●	40	32	44	220	120	60					
D3G-4132-WC06	●	41	32	44	223	123	60					
D3G-4232-WC06	●	42	32	44	226	126	60					
D3G-4332-WC06	●	43	32	44	229	129	60					
D3G-4432-WC06	●	44	32	44	232	132	60					
D3G-4540-WC08	●	45	32	44	245	135	70				SM4X11	T15
D3G-4640-WC08	●	46	40	54	248	138	70					
D3G-4740-WC08	●	47	40	54	251	141	70					
D3G-4840-WC08	●	48	40	54	254	144	70					
D3G-4940-WC08	●	49	40	54	257	147	70					
D3G-5040-WC08	●	50	40	54	260	150	70					

● Stok ürün - Stock item

○ Stok dışı ürün - Non Stock item

△ Özel Sipariş - Special order

## 4D U-DRILL TAKIMLAR / 4D U-DRILL TOOLS

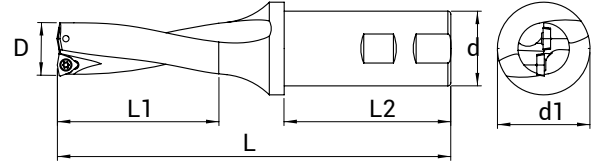
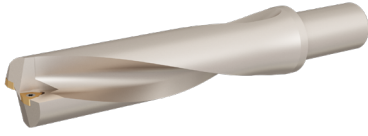

(mm)

Takim Kodu Order Code	Stok Durumu Stock Availability	D	d	d1	L	L1	L2	Uç Insert	Vida Screw	Anahtar Torx Key
D4G-15525-WC03	●	15,5	25	34	142	62	56	WCMX / WCKT 0302	SM2,5X6	T08
D4G-1625-WC03	●	16	25	34	142	64	56			
D4G-1725-WC03	●	17	25	34	146	68	56			
D4G-17525-WC03	●	17,5	25	34	150	72	56			
D4G-1825-WC03	●	18	25	34	150	72	56			
D4G-1925-WC03	●	19	25	34	154	76	56			
D4G-19525-WC03	●	19,5	25	34	159	80	56			
D4G-2025-WC04	●	20	25	34	159	80	56			
D4G-2125-WC04	●	21	25	34	164	84	56			
D4G-2225-WC04	●	22	25	34	169	88	56			
D4G-2325-WC04	●	23	25	34	174	92	56			
D4G-23525-WC04	●	23,5	25	34	174	94	56			
D4G-2425-WC05	●	24	25	34	177	96	56	WCMX / WCKT 0503	SM3X8	T10
D4G-2525-WC05	●	25	25	34	181	100	56			
D4G-25525-WC05	●	25,5	25	34	181	102	56			
D4G-2625-WC05	●	26	25	34	186	104	56			
D4G-2725-WC05	●	27	25	34	191	108	56			
D4G-27525-WC05	●	27,5	25	34	191	110	56			
D4G-2825-WC05	●	28	25	34	196	112	56			
D4G-2925-WC05	●	29	25	34	201	116	56			
D4G-3032-WC06	●	30	32	44	210	120	56			
D4G-3132-WC06	●	31	32	44	215	124	60			
D4G-31532-WC06	●	31,5	32	44	220	126	60	WCMX / WCKT 06T3	SM3,5X11X4,8	T15
D4G-3232-WC06	●	32	32	44	220	128	60			
D4G-3332-WC06	●	33	32	44	225	132	60			
D4G-33532-WC06	●	33,5	32	44	225	134	60			
D4G-3432-WC06	●	34	32	44	230	136	60			
D4G-3532-WC06	●	35	32	44	235	140	60			
D4G-3632-WC06	●	36	32	44	238	144	60			
D4G-3732-WC06	●	37	32	44	241	148	60			
D4G-3832-WC06	●	38	32	44	244	152	60			
D4G-38532-WC06	●	38,5	32	44	247	154	60			
D4G-3932-WC06	●	39	32	44	247	156	60			
D4G-4032-WC06	●	40	32	44	250	160	60			

● Stok ürün - Stock item

○ Stok dışı ürün - Non Stock item

▲ Özel Sipariş - Special order

## 4D U-DRILL TAKIMLAR / 4D U-DRILL TOOLS

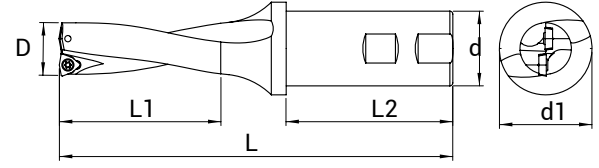
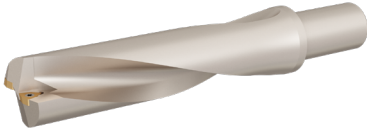

(mm)

Takım Kodu Order Code	Stok Durumu Stock Availability	D	d	d1	L	L1	L2	Uç Insert	Vida Screw	Anahtar Torx Key
D4G-4132-WC06	●	41	32	44	253	164	60	WCMX / WCKT 06T3		
D4G-41532-WC06	●	41,5	32	44	256	166	60			
D4G-4232-WC06	●	42	32	44	256	168	60			
D4G-4332-WC06	●	43	32	44	259	172	60			
D4G-4432-WC06	●	44	32	44	262	176	60			
D4G-4540-WC08	●	45	40	54	265	180	60	WCMX / WCKT 0804	SM4x11	T15
D4G-4640-WC08	●	46	40	54	268	184	60			
D4G-4740-WC08	●	47	40	54	271	188	60			
D4G-4840-WC08	●	48	40	54	274	192	60			
D4G-4940-WC08	●	49	40	54	277	196	60			
D4G-5040-WC08	●	50	40	54	280	200	60			

## 5D U-DRILL TAKIMLAR / 5D U-DRILL TOOLS

(mm)

Takım Kodu Order Code	Stok Durumu Stock Availability	D	d	d1	L	L1	L2	Uç Insert	Vida Screw	Anahtar Torx Key
D5G-1625-WC03	●	16	25	34	153	80	56	WCMX / WCKT 0302	SM2,5x6	T08
D5G-1725-WC03	●	17	25	34	158	85	56			
D5G-1825-WC03	●	18	25	34	163	90	56			
D5G-1925-WC03	●	19	25	34	168	95	56			
D5G-2025-WC04	●	20	25	34	174	100	56			
D5G-2125-WC04	●	21	25	34	180	105	56	WCMX / WCKT 0402		
D5G-2225-WC04	●	22	25	34	186	110	56			
D5G-2325-WC04	●	23	25	34	192	115	56			
D5G-2425-WC05	●	24	25	34	196	120	56			
D5G-2525-WC05	●	25	25	34	200	125	56			
D5G-2625-WC05	●	26	25	34	206	130	56	WCMX / WCKT 0503	M3x8	T10
D5G-2725-WC05	●	27	25	34	212	135	56			
D5G-2825-WC05	●	28	25	34	218	140	56			
D5G-2925-WC05	●	29	25	34	224	145	56			
D5G-3032-WC06	●	30	32	44	233	150	60			

● Stok ürün - Stock item

○ Stok dışı ürün - Non Stock item

△ Özel Sipariş - Special order

# SPMG

## ÇALIŞMA KOŞULLARI / WORKING CONDITION

		SPMG 050204		SPMG 060204		SPMT 07T308		SPMG 090408		SPMG 110408		SPMG 140512	
		Drill Dia (mm) Takım Çapı	Ø12.5-15	Ø15.5-21.5	Ø22-27.5	Ø28-33	Ø34-41	Ø42-50					
ISO	Malzeme Grubu Material Group	Vc(m/min)	Feed (mm/rev)										
P	Karbon Çeliği Carbon Steel	180-250	0.05-0.08	0.06-0.10	0.06-0.12	0.07-0.13	0.08-0.15	0.08-0.16					
	Düşük Alaşımli Çelik Low Alloy Steel	150-220	0.06-0.12	0.08-0.14	0.10-0.18	0.12-0.22	0.12-0.23	0.13-0.24					
	Yüksek Alaşımli Çelik High Alloy Steel	130-180	0.06-0.10	0.08-0.15	0.10-0.20	0.12-0.23	0.12-0.24	0.13-0.25					
M	Paslanmaz Çelik Stainless Steel	170-240	0.05-0.10	0.06-0.12	0.08-0.15	0.09-0.16	0.10-0.17	0.11-0.19					
K	Pik Dökme Demir Gray Cast Iron	180-250	0.06-0.12	0.08-0.16	0.12-0.20	0.15-0.25	0.16-0.28	0.18-0.30					
	Sfero Dökme Demir Nodular Cast Iron	130-200	0.06-0.10	0.08-0.15	0.10-0.18	0.12-0.20	0.15-0.23	0.16-0.25					
N	Alaşımli Alüminyum Alloyed Aluminum	325-400	0.06-0.14	0.08-0.15	0.10-0.20	0.12-0.22	0.14-0.23	0.15-0.26					
S	Isiya Dirençli Alaşım Heat Resistant Alloy	30-60	0.05-0.10	0.06-0.14	0.08-0.18	0.10-0.22	0.12-0.22	0.14-0.24					

# WCMX

## ÇALIŞMA KOŞULLARI / WORKING CONDITION

		WCMX 030204		WCMX 040204		WCMX 050308		WCMX 06T308		WCMX 080408	
		Drill Dia (mm) Takım Çapı	Ø16-19.5	Ø20-23.5	Ø24-29	Ø30-44	Ø44-50				
ISO	Malzeme Grubu Material Group	Vc(m/min)	Feed (mm/rev)								
P	Karbon Çeliği Carbon Steel	180-250	0.04-0.065	0.06-0.10	0.06-0.12	0.07-0.13	0.08-0.15				
	Düşük Alaşımli Çelik Low Alloy Steel	150-220	0.05-0.09	0.08-0.14	0.10-0.18	0.12-0.22	0.12-0.23				
	Yüksek Alaşımli Çelik High Alloy Steel	130-180	0.04-0.07	0.08-0.15	0.10-0.20	0.12-0.23	0.12-0.24				
M	Paslanmaz Çelik Stainless Steel	170-240	0.04-0.07	0.06-0.12	0.08-0.15	0.09-0.12	0.09-0.13				
K	Pik Dökme Demir Gray Cast Iron	180-250	0.04-0.12	0.05-0.14	0.06-0.18	0.10-0.23	0.10-0.28				
	Sfero Dökme Demir Nodular Cast Iron	130-200	0.04-0.08	0.04-0.08	0.04-0.10	0.05-0.14	0.05-0.14				
N	Alaşımli Alüminyum Alloyed Aluminum	325-400	0.05-0.14	0.06-0.15	0.10-0.20	0.10-0.22	0.12-0.23				
S	Isiya Dirençli Alaşım Heat Resistant Alloy	30-60	0.05-0.10	0.06-0.14	0.08-0.16	0.08-0.14	0.08-0.15				

● Stok ürün - Stock item

○ Stok dışı ürün - Non Stock item

△ Özel Sipariş - Special order

## DEĞİŞTİRİLEBİLİR KARBÜR UÇ VE TAKIMLAR

### INDEXABLE DRILLS AND INSERTS

## SPMT

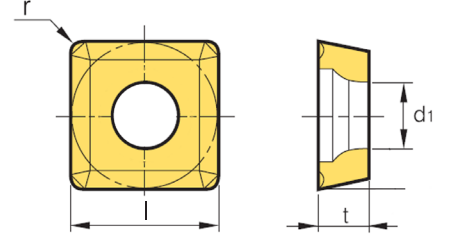

Ürün Görseli Product Image	CB	Uç Kodu Insert Code	U					Ölçüler - Dimensions				
			TP1630	TP2625	TP3630	TP4630	TP5620	l	d	t	r	d1
	D	SPMT 040204	○					4.70	-	2.4	0.4	2.3
		SPMT 050204	●					5.10	-	2.4	0.4	2.3
		SPMT 060205	●					6.20	-	2.5	0.5	2.5
		SPMT 07T208	●					7.50	-	2.8	0.8	2.8
		SPMT 090308	●					9.20	-	3.3	0.8	3.4
		SPMT 11T308	●					11.0	-	4.0	0.8	4.0
		SPMT 130410	○					13.0	-	4.5	1.0	4.5

## XOMT

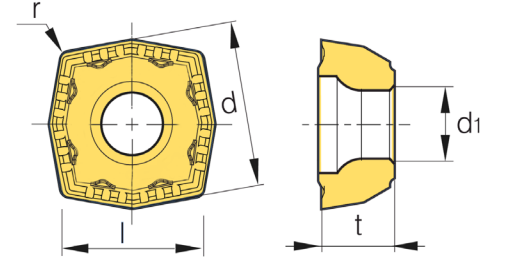

Ürün Görseli Product Image	CB	Uç Kodu Insert Code	U					Ölçüler - Dimensions				
			TP1630	TP2625	TP3630	TP4630	TP5620	l	d	t	r	d1
	D	XOMT 040204	○					4.3	4.9	2.4	0.4	2.3
		XOMT 050204	●					4.8	5.4	2.4	0.4	2.3
		XOMT 060204	●					5.8	6.6	2.5	0.4	2.5
		XOMT 07T205	●					6.9	7.8	2.8	0.5	2.8
		XOMT 090305	●					8.4	9.6	3.3	0.5	3.4
		XOMT 11T306	●					10.0	11.4	4.0	0.6	4.0
		XOMT 130406	●					11.9	13.6	4.5	0.6	4.5

● Stok ürün - Stock item

○ Stok dışı ürün - Non Stock item

△ Özel Sipariş - Special order

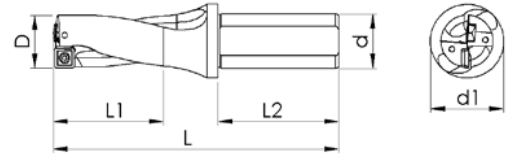
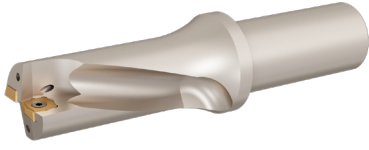
2D PRO DRILL TAKIMLAR / **2D** PRO DRILL TOOLS

(mm)

Takım Kodu Order Code	Stok Durumu Stock Availability	D	d	d1	L	L1	L2	Uç Insert	Vida Screw	Anahtar Torx Key
D2K-1625-SX05	●	16	25	34	110	32	50	SPMT/XOMT 0502	M2,22X5	T06
D2K-1725-SX06	●	17	25	34	112	34	56	SPMT/XOMT 0602	M2,2X6	
D2K-1825-SX06	●	18	25	34	114	36	56			
D2K-1925-SX06	●	19	25	34	116	38	56			
D2K-2025-SX07	●	20	25	34	119	40	56	SPMT/XOMT 07T2	M3X7	T08
D2K-2125-SX07	●	21	25	34	122	42	56			
D2K-2225-SX07	●	22	25	34	125	44	56			
D2K-2325-SX07	●	23	25	34	128	46	56			
D2K-2425-SX09	●	24	25	34	129	48	56	SPMT/XOMT 0903	M3X8	T08
D2K-2525-SX09	●	25	25	34	131	50	56			
D2K-2625-SX09	●	26	25	34	134	52	56			
D2K-2725-SX09	●	27	25	34	137	54	56			
D2K-2825-SX09	●	28	25	34	140	56	56			
D2K-2925-SX09	●	29	25	34	143	58	56			
D2K-3032-SX11	●	30	32	44	150	60	60	SPMT/XOMT 11T3	M3,5X9	T15
D2K-3132-SX11	●	31	32	44	153	62	60			
D2K-3232-SX11	●	32	32	44	156	64	60			
D2K-3332-SX11	●	33	32	44	159	66	60			
D2K-3432-SX11	●	34	32	44	162	68	60			
D2K-3532-SX11	●	35	32	44	165	70	60			

● Stok ürün - Stock item

○ Stok dışı ürün - Non Stock item

▲ Özel Sipariş - Special order

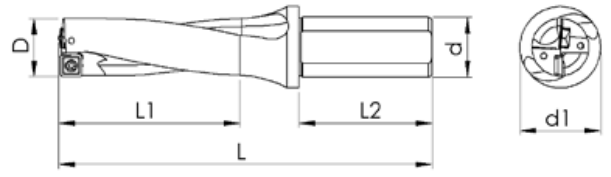
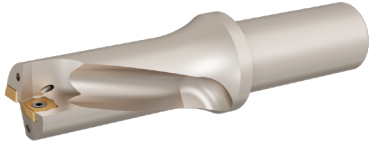
3D PRO DRILL TAKIMLAR / **3D** PRO DRILL TOOLS

(mm)

Takım Kodu Order Code	Stok Durumu Stock Availability	D	d	d1	L	L1	L2	Uç Insert	Vida Screw	Anahtar Torx Key
D3K-1625-SX05	●	16	25	34	126	48	56	SPMT/XOMT 0502	M2,2X5	T06
D3K-1725-SX06	●	17	25	34	129	51	56	SPMT/XOMT 0602	M2,2X6	
D3K-1825-SX06	●	18	25	34	132	54	56			
D3K-1925-SX06	●	19	25	34	135	57	56			
D3K-2025-SX07	●	20	25	34	139	60	56	SPMT/XOMT 07T2	M2,2X7	T08
D3K-2125-SX07	●	21	25	34	143	63	56			
D3K-2225-SX07	●	22	25	34	147	66	56			
D3K-2325-SX07	●	23	25	34	151	69	56			
D3K-2425-SX09	●	24	25	34	153	72	56	SPMT/XOMT 0903	M3X8	
D3K-2525-SX09	●	25	25	34	156	75	56			
D3K-2625-SX09	●	26	25	34	160	78	56			
D3K-2725-SX09	●	27	25	34	164	81	56			
D3K-2825-SX09	●	28	25	34	168	84	56			
D3K-2925-SX09	●	29	25	34	172	87	56			
D3K-3032-SX11	●	30	32	44	180	90	60	SPMT/XOMT 11T3	M3,5X9	T15
D3K-3132-SX11	●	31	32	44	184	93	60			
D3K-3232-SX11	●	32	32	44	188	96	60			
D3K-3332-SX11	●	33	32	44	192	99	60			
D3K-3432-SX11	●	34	32	44	192	102	60			
D3K-3532-SX11	●	35	32	44	200	105	60			

## 4D PRO DRILL TAKIMLAR / 4D PRO DRILL TOOLS

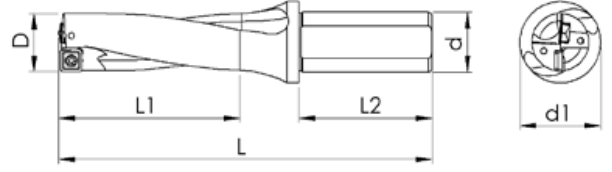
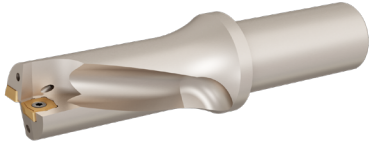

(mm)

Takim Kodu Order Code	Stok Durumu Stock Availability	D	d	d1	L	L1	L2	Uç Insert	Vida Screw	Anahtar Torx Key	
D4K-1625-SX05	●	16	25	34	142	64	56	SPMT/XOMT 0502	M2,2X5	T06	
D4K-1725-SX06	●	17	25	34	146	68	56	SPMT/XOMT 0602	M2,2X6		
D4K-1825-SX06	●	18	25	34	150	72	56				
D4K-1925-SX06	●	19	25	34	154	76	56	SPMT/XOMT 07T2	M3X7	T08	
D4K-2025-SX07	●	20	25	34	159	80	56				
D4K-2125-SX07	●	21	25	34	164	84	56				
D4K-2225-SX07	●	22	25	34	169	88	56				
D4K-2325-SX07	●	23	25	34	174	92	56	SPMT/XOMT 0903	M3X8		
D4K-2425-SX09	●	24	25	34	177	96	56				
D4K-2525-SX09	●	25	25	34	181	100	56				
D4K-2625-SX09	●	26	25	34	186	104	56				
D4K-2725-SX09	●	27	25	34	191	108	56				
D4K-2825-SX09	●	28	25	34	196	112	56	SPMT/XOMT 11T3	M3,5X9		T15
D4K-2925-SX09	●	29	25	34	201	116	56				
D4K-3032-SX11	●	30	32	44	210	120	60				
D4K-3132-SX11	●	31	32	44	215	124	60				
D4K-3232-SX11	●	32	32	44	220	128	60				
D4K-3332-SX11	●	33	32	44	225	132	60	SPMT/XOMT 11T3	M3,5X9	T15	
D4K-3432-SX11	●	34	32	44	230	136	60				
D4K-3532-SX11	●	35	32	44	235	140	60				

## DEĞİŞTİRİLEBİLİR KARBÜR UÇ VE TAKIMLAR

### INDEXABLE DRILLS AND INSERTS

## SOMT

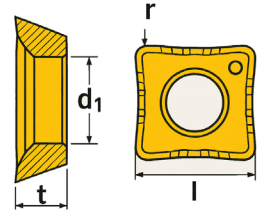

Ürün Görseli Product Image	CB	Uç Kodu Insert Code	U					K	Ölçüler- Dimensions			
			TP1630	TP2625	TP3630	TP4630	TP5620		TC2215	l	d1	t
	DP	SOMT 050204	●					Δ	4.90	2.21	2.38	0.4
		SOMT 060204	●			○		Δ	5.70	2.55	2.38	0.4
		SOMT 070306	●			●		Δ	6.80	2.55	2.38	0.6
		SOMT 08T306	●			○		Δ	7.90	2.80	3.97	0.6
		SOMT 09T308	●			○		Δ	9.20	3.81	3.97	0.8
		SOMT 11T308	●					Δ	11.0	3.81	3.97	0.8
		SOMT 130408	○					Δ	12.8	4.40	4.40	0.8
		SOMT 150510	○					Δ	15	5.40	4.80	1.0

## TPMX

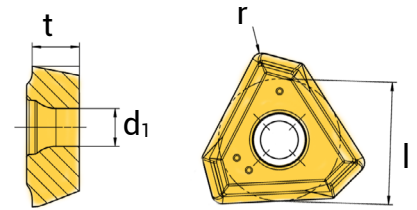

Ürün Görseli Product Image	CB	Uç Kodu Insert Code	U					Ölçüler- Dimensions			
			TP1630	TP2625	TP3630	TP4630	TP5620	l	d1	t	r
		TPMX 1403R				○		8.45	2.87	3.50	0.8
		TPMX 1704R				○		10.30	3.90	4.0	0.8
		TPMX 2405R/L				○		14.20	4.40	5.50	1.2

● Stok ürün - Stock item

○ Stok dışı ürün - Non Stock item

Δ Özel Sipariş - Special order

## 2D TIGER DRILL TAKIMLAR/ 2D TIGER DRILL TOOLS

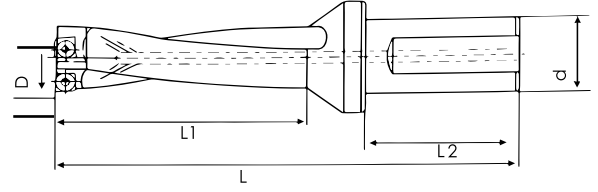

(mm)

Takım Kodu Order Code	Stok Durumu Stock Availability	L	L1	L2	D	d	Uç Insert	Vida Screw	Anahtar Torx Key	
D2T-1388-SOMT05	○	88	29	44	13	20	SOMT 050204	M2X5	T06	
D2T-13589-SOMT05	○	89	30		13,5					
D2T-1490-SOMT05	○	90	31		14					
D2T-14591-SOMT05	○	91	32		14,5					
D2T-1592-SOMT05	○	92	33		15					
D2T-15593-SOMT05	○	93	34		15,5					
D2T-1694-SOMT05	○	94	35		16					
D2T-16596-SOMT06	○	95	36	56	16,5	SOMT 060204	M2,2X5	T07		
D2T-1796-SOMT06	○	96	37		17					
D2T-175110-SOMT06	○	109	38		17,5					
D2T-18110-SOMT06	○	110	39		18					
D2T-185111-SOMT06	○	111	40		18,5					
D2T-19112-SOMT06	○	112	41		19					
D2T-195113-SOMT07	○	113	42		19,5					
D2T-20114-SOMT07	○	114	43	60	20	SOMT 070306	M2,5X7	T08		
D2T205115-SOMT07	○	115	44		20,5					
D2T-21116-SOMT07	○	116	45		21					
D2T-215117-SOMT07	○	117	46		21,5					
D2T-22118-SOMT07	○	118	47		22					
D2T-225119-SOMT08	○	119	48		22,5					
D2T-23123-SOMT08	○	123	49		23					
D2T-235124-SOMT08	○	124	50	23,5						
D2T-24125-SOMT08	○	125	51	SOMT 08T306	24	M2,5X7	T08			
D2T-245127-SOMT08	○	126	52		24,5					
D2T-25127-SOMT08	○	127	53		25					
D2T-255134-SOMT08	○	134	54		25,5					
D2T-26135-SOMT08	○	135	55		26					
D2T-265136-SOMT09	○	136	56		SOMT 09T308			26,5		
D2T-27137-SOMT09	○	137	57					27		
D2T-275138-SOMT09	○	138	58	27,5						
D2T-28139-SOMT09	○	139	59	28						
D2T-285140-SOMT09	○	140	60	28,5						

● Stok ürün - Stock item

○ Stok dışı ürün - Non Stock item

▲ Özel Sipariş - Special order

## 2D TIGER DRILL TAKIMLAR/ 2D TIGER DRILL TOOLS

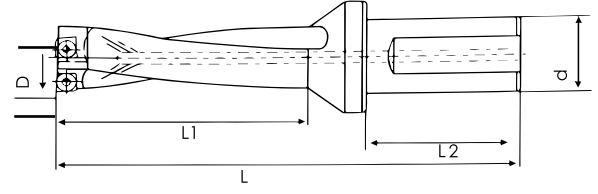

(mm)

Takim Kodu Order Code	Stok Durumu Stock Availability	L	L1	L2	D	d	Uç Insert	Vida Screw	Anahtar Torx Key
D2T-29143-SOMT09	○	143	62		29		SOMT 09T308	M4X10	T15
D2T-295144-SOMT09	○	144	63	60	29,5	32			
D2T-30148-SOMT09	○	148	64		30				
D2T-305149-SOMT09	○	149	65		30,5				
D2T-31150-SOMT09	○	150	66		31				
D2T-315151-SOMT09	○	151	67		31,5				
D2T-32152-SOMT11	○	152	68		32				
D2T-325153-SOMT11	○	153	69		32,5		SOMT 11T308		
D2T-33154-SOMT11	○	154	70		33				
D2T-335155-SOMT11	○	155	71		33,5				
D2T-34156-SOMT11	○	156	72		34				
D2T-345157-SOMT11	○	157	73		34,5				
D2T-35158-SOMT11	○	158	74		35				
D2T-355159-SOMT11	○	159	75		35,5				
D2T-36160-SOMT11	○	160	76	60	36	32	SOMT 130408	M4X10	T15
D2T-365161-SOMT11	○	161	77		36,5				
D2T-37169-SOMT13	○	169	79		37				
D2T-375170-SOMT13	○	170	80		37,5				
D2T-38171-SOMT13	○	171	81		38				
D2T-385172-SOMT13	○	172	82		38,5				
D2T-39174-SOMT13	○	173	83		39				
D2T-395185-SOMT13	○	174	84		39,5		SOMT 150510	M5X11	T20
D2T-40185-SOMT13	○	185	85		40				
D2T-41187-SOMT13	○	187	87		41				
D2T-42189-SOMT13	○	189	89		42				
D2T-43191-SOMT13	○	191	91		43				
D2T-44193-SOMT15	○	193	93		44				
D2T-45195-SOMT15	○	195	95	70	45	40			
D2T-46197-SOMT15	○	197	97		46				
D2T-47199-SOMT15	○	199	99		47				
D2T-48201-SOMT15	○	201	101		48				
D2T-49203-SOMT15	○	203	103		49				
D2T-50205-SOMT15	○	205	105		50				

● Stok ürün - Stock item

○ Stok dışı ürün - Non Stock item

△ Özel Sipariş - Special order

## 3D TIGER DRILL TAKIMLAR/ 3D TIGER DRILL TOOLS

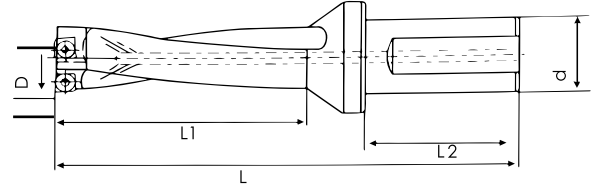

(mm)

Takım Kodu Order Code	Stok Durumu Stock Availability	L	L1	L2	D	d	Uç Insert	Vida Screw	Anahtar Torx Key
D3T-13101-SOMT05	○	101	42	44	13	20	SOMT 050204	M2X5	T06
D3T-135103-SOMT05	○	103	44		13,5				
D3T-14104-SOMT05	○	104	45		14				
D3T-145106-SOMT05	○	106	47		14,5				
D3T-15107-SOMT05	○	107	48		15				
D3T-155109-SOMT05	○	109	50		15,5				
D3T-16110-SOMT05	○	110	51		16				
D3T-165112-SOMT06	○	112	53	56	16,5	25	SOMT 060204	M2,2MX5	T07
D3T-17113-SOMT06	○	113	54		17				
D3T-175127-SOMT06	○	127	56		17,5				
D3T-18128-SOMT06	○	128	57		18				
D3T-185130-SOMT06	○	130	59		18,5				
D3T-19131-SOMT06	○	131	60		19				
D3T-195133-SOMT07	○	133	62		19,5				
D3T-20134-SOMT07	○	134	63	20	SOMT 070306	25	SOMT 08T306	M2,5X7	T08
D3T-205136-SOMT07	○	136	65	20,5					
D3T-21137-SOMT07	○	137	66	21					
D3T-215139-SOMT07	○	139	68	21,5					
D3T-22140-SOMT07	○	140	69	22					
D3T-225142-SOMT08	○	142	71	22,5					
D3T-23146-SOMT08	○	146	72	23					
D3T-235148-SOMT08	○	148	74	23,5					
D3T-24149-SOMT08	○	149	75	24	60	32	SOMT 08T306	M2,5X7	T08
D3T-245151-SOMT08	○	151	77	24,5					
D3T-25152-SOMT08	○	152	78	25					
D3T-255160-SOMT08	○	160	8	25,5					
D3T-26161-SOMT08	○	161	81	26					

## 3D TIGER DRILL TAKIMLAR/ 3D TIGER DRILL TOOLS

Takım Kodu Order Code	Stok Durumu Stock Availability	L	L1	L2	D	d	Uç Insert	Vida Screw	Anahtar Torx Key	
D3T-265163-SOMT09	○	163	83		26,5		SOMT 09T308			
D3T-27164-SOMT09	○	164	84		27					
D3T-275166-SOMT09	○	166	86		27,5					
D3T-28167-SOMT09	○	167	87		28					
D3T-285169-SOMT09	○	169	89		28,5					
D3T-29172-SOMT09	○	172	91		29					
D3T-295174-SOMT09	○	174	93		29,5					
D3T-30178-SOMT09	○	178	94		30					
D3T-305180-SOMT09	○	180	96		30,5					
D3T-31181-SOMT09	○	181	97		31					
D3T-315183-SOMT09	○	183	99		31,5			M3,5X8,5	T15	
D3T-32184-SOMT11	○	184	100		32		SOMT 11T308			
D3T-325186-SOMT11	○	186	102		32,5					
D3T-33187-SOMT11	○	187	103	60	33	32				
D3T-335189-SOMT11	○	189	105		33,5					
D3T-34190-SOMT11	○	190	106		34					
D3T-345192-SOMT11	○	192	108		34,5					
D3T-35193-SOMT11	○	193	109		35					
D3T-355195-SOMT11	○	195	111		35,5					
D3T-36196-SOMT11	○	196	112		36					
D3T-365198-SOMT11	○	198	114		36,5					
D3T-37206-SOMT13	○	206	116		37		SOMT 130408			
D3T-375208-SOMT13	○	208	118		37,5					
D3T-38209-SOMT13	○	209	119		38					
D3T-385211-SOMT13	○	211	121		38,5					
D3T-39212-SOMT13	○	212	122		39				M4X10	T15
D3T-395214-SOMT13	○	214	124		39,5					
D3T-40225-SOMT13	○	225	125		40					
D3T-41228-SOMT13	○	228	128		41					
D3T-42231-SOMT13	○	231	131		42					
D3T-43234-SOMT13	○	234	134		43					
D3T-44237-SOMT15	○	237	137		44		SOMT 150510			
D3T-45240-SOMT15	○	240	140	70	45	40				
D3T-45243-SOMT15	○	243	143		46					
D3T-47246-SOMT15	○	246	146		47				M5X11	T20
D3T-48249-SOMT15	○	249	149		48					
D3T-49252-SOMT15	○	252	152		49					
D3T-50255-SOMT15	○	255	155		50					

● Stok ürün - Stock item

○ Stok dışı ürün - Non Stock item

△ Özel Sipariş - Special order

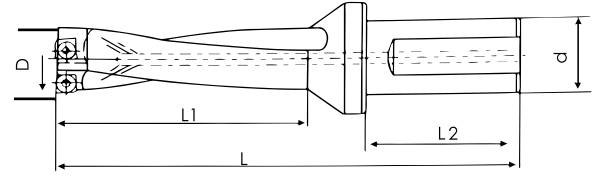
4D TIGER DRILL TAKIMLAR/ **4D** TIGER DRILL TOOLS

(mm)

Takım Kodu Order Code	Stok Durumu Stock Availability	L	L1	L2	D	d	Uç Insert	Vida Screw	Anahtar Torx Key
D4T-14118-SOMT05	○	118	59	44	14	20	SOMT 050204	M2X5	T06
D4T-145120-SOMT05	○	120	61		14,5				
D4T15122-SOMT05	○	122	63		15				
D4T-155124-SOMT05	○	124	65		15,5				
D4T-16126-SOMT05	○	126	67		16				
D4T-165128-SOMT06	○	128	69		16,5				
D4T-17130-SOMT06	○	130	71	56	17	25	SOMT 060204	M2,2X5	T07
D4T-175144-SOMT06	○	144	73		17,5				
D4T-18146-SOMT06	○	146	75		18				
D4T-185148-SOMT06	○	148	77		18,5				
D4T-19150-SOMT06	○	150	79		19				
D4T-195152-SOMT07	○	152	81		19,5				
D4T-20154-SOMT07	○	154	83	60	20	32	SOMT 070306	M2,5X7	T08
D4T-205156-SOMT07	○	156	85		20,5				
D4T-21158-SOMT07	○	158	87		21				
D4T-215160-SOMT07	○	160	89		21,5				
D4T-22162-SOMT07	○	162	91		22				
D4T-225164-SOMT08	○	164	93		22,5				
D4T-23169-SOMT08	○	169	95	60	23	32	SOMT 08T306	M2,5X7	T08
D4T-235171-SOMT08	○	171	97		23,5				
D4T-24173-SOMT08	○	173	99		24				
D4T-245175-SOMT08	○	175	101		24,5				
D4T-25177-SOMT08	○	177	103		25				
D4T-255185-SOMT08	○	185	105		25,5				
D4T-26187-SOMT08	○	187	107	26	32				

## 4D TIGER DRILL TAKIMLAR/ 4D TIGER DRILL TOOLS

Takim Kodu Order Code	Stok Durumu Stock Availability	L	L1	L2	D	d	Uç Insert	Vida Screw	Anahtar Torx Key			
D4T-265189-SOMT09	○	189	109		26,5		SOMT 09T308	M3,5X8,5	T15			
D4T-27191-SOMT09	○	191	111		27							
D4T-275193-SOMT09	○	193	113		27,5							
D4T-28195-SOMT09	○	195	115		28							
D4T-285197-SOMT09	○	197	117		28,5							
D4T-29201-SOMT09	○	201	120		29							
D4T-295203-SOMT09	○	203	122		29,5							
D4T-30208-SOMT09	○	208	124		30							
D4T-305210-SOMT09	○	210	126		30,5							
D4T-31212-SOMT09	○	212	128		31							
D4T-315214-SOMT09	○	214	130		31,5							
D4T-32216-SOMT11	○	216	132		32		SOMT 11T308	M4X10	T15			
D4T-325218-SOMT11	○	218	134		32,5							
D4T-33220-SOMT11	○	220	136	60	33	32						
D4T-335222-SOMT11	○	222	138		33,5							
D4T-34224-SOMT11	○	224	140		34							
D4T-345226-SOMT11	○	226	142		34,5							
D4T-35228-SOMT11	○	228	144		35							
D4T-355230-SOMT11	○	230	146		35,5							
D4T-36232-SOMT11	○	232	148		36							
D4T-365234-SOMT11	○	234	150		36,5							
D4T-37243-SOMT13	○	243	153		37					SOMT 130408	M4X10	T15
D4T-375245-SOMT13	○	245	155		37,5							
D4T-38247-SOMT13	○	247	157		38							
D4T-385249-SOMT13	○	249	159		38,5							
D4T-39251-SOMT13	○	251	161		39							
D4T-395253-SOMT13	○	253	163		39,5							
D4T-40265-SOMT13	○	265	165		40		SOMT 150510	M5X11	T20			
D4T-41269-SOMT13	○	269	169		41							
D4T-42273-SOMT13	○	273	173		42							
D4T-43277-SOMT13	○	277	177		43							
D4T-44281-SOMT15	○	281	181		44							
D4T-45285-SOMT15	○	285	185	70	45	40						
D4T-46289-SOMT15	○	289	189		46							
D4T-47293-SOMT15	○	293	193		47							
D4T-48297-SOMT15	○	297	197		48							
D4T-49302-SOMT15	○	302	201		49							
D4T-50305-SOMT15	○	305	205		50							

● Stok ürün - Stock item

○ Stok dışı ürün - Non Stock item

△ Özel Sipariş - Special order

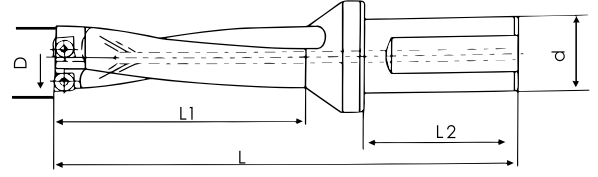
5D TIGER DRILL TAKIMLAR/ **5D** TIGER DRILL TOOLS

(mm)

Takım Kodu Order Code	Stok Durumu Stock Availability	L	L1	L2	D	d	Uç Insert	Vida Screw	Anahtar Torx Key
D5T-16142-SOMT05	○	142	83		16		SOMT 050204	M2X5	T06
D5T-165145-SOMT06	○	145	86	44	16,5	20	SOMT 060204	M2,2X5	T07
D5T-17147-SOMT06	○	147	88		17				
D5T-175162-SOMT06	○	162	91		17,5				
D5T-18164-SOMT06	○	164	93		18				
D5T185167-SOMT06	○	167	96		18,5				
D5T-19169-SOMT06	○	169	98		19				
D5T-195172-SOMT07	○	172	101		19,5				
D5T-20174-SOMT07	○	174	103		20		SOMT 070306	M2,2X5	T07
D5T-205177-SOMT07	○	177	106		20,5				
D5T-21179-SOMT07	○	179	108	56	21	25			
D5T-215182-SOMT07	○	182	111		21,5				
D5T-22184-SOMT07	○	184	113		22				
D5T-225187-SOMT08	○	187	116		22,5				
D5T-23192-SOMT08	○	192	118		23				
D5T-235195-SOMT08	○	195	121		23,5		SOMT 08T306	M2,5X7	T08
D5T-24197-SOMT08	○	197	123		24				
D5T-245200-SOMT08	○	200	126		24,5				
D5T-25202-SOMT08	○	202	128		25				
D5T-255213-SOMT08	○	213	130		25,5				
D5T-26216-SOMT08	○	216	133		26				
D5T-265219-SOMT09	○	219	136		26,5				
D5T-27220-SOMT09	○	220	138	60	27	32	SOMT 09T308	M3,5X8,5	T15
D5T-275221-SOMT09	○	221	141		27,5				
D5T-28223-SOMT09	○	223	143		28				
D5T-285226-SOMT09	○	226	146		28,5				
D5T-29230-SOMT09	○	230	148		29				

## 5D TIGER DRILL TAKIMLAR/ 5D TIGER DRILL TOOLS

Takim Kodu Order Code	Stok Durumu Stock Availability	L	L1	L2	D	d	Uç Insert	Vida Screw	Anahtar Torx Key
D5T-295233-SOMT09	○	233	151		29,5		SOMT 09T308		
D5T-30238-SOMT09	○	238	154		30				
D5T-305241-SOMT09	○	241	157		30,5				
D5T-31243-SOMT09	○	243	159		31				
D5T-315245-SOMT09	○	245	162		31,5				
D5T-32248-SOMT11	○	248	164		32				
D5T-325251-SOMT11	○	251	167		32,5		SOMT 11T308	M3,5X8,5	T15
D5T-33253-SOMT11	○	253	169		33				
D5T-335255-SOMT11	○	255	172		33,5				
D5T-34258-SOMT11	○	258	174		34				
D5T-345261-SOMT11	○	261	177	60	34,5	32			
D5T-35263-SOMT11	○	263	179		35				
D5T-355265-SOMT11	○	265	182		35,5				
D5T-36268-SOMT11	○	268	184		36				
D5T-365271-SOMT11	○	271	187		36,5				
D5T-37280-SOMT13	○	280	190		37				
D5T-375283-SOMT13	○	283	193		37,5		SOMT 130408	M4X10	T15
D5T-38285-SOMT13	○	285	195		38				
D5T-385288-SOMT13	○	288	198		38,5				
D5T-39290-SOMT13	○	290	200		39				
D5T-395293-SOMT13	○	293	203		39,5				
D5T-40305-SOMT13	○	305	205		40				
D5T-41310-SOMT13	○	310	210		41				
D5T-42315-SOMT13	○	315	215		42				
D5T-43320-SOMT13	○	320	220		43				
D5T-44325-SOMT15	○	325	225		44				
D5T-45330-SOMT15	○	330	230	70	45	40	SOMT 150510	M5X11	T20
D5T-46335-SOMT15	○	335	235		46				
D5T-47340-SOMT15	○	340	240		47				
D5T-48345-SOMT15	○	345	245		48				
D5T-49350-SOMT15	○	350	250		49				
D5T-50355-SOMT15	○	355	255		50				

# SPMT- XOMT

## ÇALIŞMA KOŞULLARI / WORKING CONDITION

		SPMT 050204 XOMT 050204		SPMT 060205 XOMT 060204		SPMT 07T208 XOMT 07T205		SPMT 090308 XOMT 090305		SPMT 11T308 XOMT 11T306	
		Drill Dia (mm) Takım Çapı	Ø16	Ø17-19	Ø20-23	Ø24-29	Ø30-35				
ISO	Malzeme Grubu Material Group	Vc(m/min)	Feed (mm/rev)								
P	Karbon Çeliği Carbon Steel	120-180	0.04-0.08	0.04-0.08	0.04-0.08	0.04-0.08	0.04-0.08	0.04-0.08	0.04-0.08	0.04-0.08	0.04-0.08
	Düşük Alaşımli Çelik Low Alloy Steel	90-150	0.06-0.12	0.06-0.12	0.06-0.12	0.06-0.12	0.06-0.14	0.06-0.16	0.06-0.16	0.06-0.16	0.06-0.16
	Yüksek Alaşımli Çelik High Alloy Steel	50-120	0.04-0.08	0.06-0.08	0.06-0.08	0.06-0.08	0.06-0.10	0.06-0.12	0.06-0.12	0.06-0.12	0.06-0.12
M	Paslanmaz Çelik Stainless Steel	100-160	0.04-0.07	0.04-0.07	0.04-0.07	0.04-0.07	0.04-0.07	0.04-0.08	0.04-0.08	0.04-0.08	0.04-0.08
K	Pik Dökme Demir Gray Cast Iron	150-250	0.04-0.12	0.05-0.14	0.05-0.14	0.05-0.14	0.06-0.18	0.10-0.20	0.10-0.20	0.10-0.20	0.10-0.20
	Sfero Dökme Demir Nodular Cast Iron	100-160	0.04-0.07	0.04-0.08	0.04-0.08	0.04-0.08	0.04-0.10	0.05-0.12	0.05-0.12	0.05-0.12	0.05-0.12

# SOMT

## ÇALIŞMA KOŞULLARI / WORKING CONDITION

		SOMT 050204		SOMT 060204		SOMT 070306		SOMT 08T306		SOMT 09T308		SOMT 11T308		SOMT 130408		SOMT 150510	
		Drill Dia (mm) Takım Çapı	Ø13-16	Ø16.5-19	Ø19.5-22	Ø22.5-26	Ø26.5-31.5	Ø32-36.5	Ø37-43	Ø44-50							
ISO	Malzeme Grubu Material Group	Vc(m/min)	Feed (mm/rev)														
P	Karbon Çeliği Carbon Steel	180-250	0.04-0.06	0.04-0.06	0.04-0.08	0.04-0.08	0.04-0.08	0.04-0.08	0.04-0.08	0.04-0.08	0.04-0.08	0.04-0.08	0.04-0.08	0.04-0.08	0.04-0.08	0.04-0.08	0.04-0.08
	Düşük Alaşımli Çelik Low Alloy Steel	150-220	0.06-0.16	0.06-0.16	0.08-0.20	0.08-0.20	0.08-0.20	0.08-0.20	0.09-0.20	0.09-0.22	0.09-0.22	0.09-0.22	0.09-0.22	0.09-0.22	0.09-0.22	0.09-0.22	0.09-0.22
	Yüksek Alaşımli Çelik High Alloy Steel	130-180	0.06-0.12	0.06-0.12	0.06-0.12	0.08-0.16	0.08-0.16	0.08-0.16	0.08-0.18	0.08-0.18	0.08-0.18	0.08-0.18	0.08-0.18	0.08-0.18	0.08-0.18	0.08-0.18	0.08-0.18
M	Paslanmaz Çelik Stainless Steel	170-240	0.06-0.12	0.06-0.12	0.06-0.16	0.06-0.16	0.06-0.16	0.06-0.18	0.06-0.18	0.06-0.18	0.06-0.18	0.06-0.18	0.06-0.18	0.06-0.18	0.06-0.18	0.06-0.18	0.06-0.18
K	Pik Dökme Demir Gray Cast Iron	180-250	0.08-0.18	0.08-0.18	0.10-0.20	0.10-0.20	0.11-0.22	0.12-0.22	0.10-0.24	0.10-0.24	0.10-0.24	0.10-0.24	0.10-0.24	0.10-0.24	0.10-0.24	0.10-0.24	0.10-0.24
	Sfero Dökme Demir Nodular Cast Iron	130-200	0.08-0.18	0.08-0.18	0.10-0.20	0.10-0.20	0.10-0.22	0.10-0.22	0.10-0.22	0.10-0.22	0.10-0.22	0.10-0.22	0.10-0.22	0.10-0.22	0.10-0.22	0.10-0.22	0.10-0.22

● Stok ürün - Stock item

○ Stok dışı ürün - Non Stock item

△ Özel Sipariş - Special order

## DEĞİŞTİRİLEBİLİR KARBÜR UÇ VE TAKIMLAR

### INDEXABLE DRILLS AND INSERTS

## XCMT

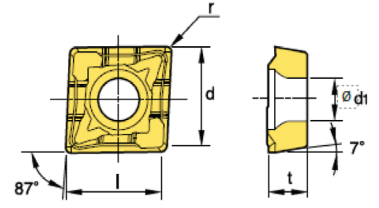

Ürün Görsele Product Image	CB	Uç Kodu Insert Code	U	Ölçüler- Dimensions				
			TP2625J	l	d	t	r	d1
		XCMT 050204-CM	●	5.0	5.4	2.10	0.4	2.3
		XCMT 060204-CM	●	6.0	6.4	2.38	0.4	2.5
		XCMT 070304-CM	●	7.0	7.4	3.18	0.4	2.8
		XCMT 080304-CM	●	8.0	8.4	3.18	0.4	3.4
		XCMT 10T304-CM	●	10.0	10.4	3.97	0.4	4.0

## SPEED TURN TAKIMLAR / SPEED TURN HOLDERS

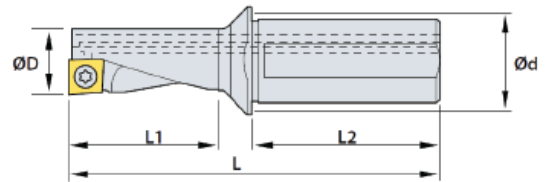
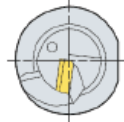

(mm)

Takım Kodu Order Code	Stok Durumu Stock Availability	D	d	L	L1	L2	Uç Insert	Vida Screw	Anahtar Torx Key
SF-10R/L-2.5D-C16	○	10	16	78	25	42	XCMT 050204	M2.0X5	T6
SF-12R/L-2.5D-C16	○	12	16	87	30	45	XCMT 060204	M2.2X5	
SF-14R/L-2.5D-C16	○	14	16	92	35	45	XCMT 070304	M2.5X6	T8
SF-16R/L-2.5D-C20	○	16	20	102	40	50	XCMT 080304	M3.0X8	T10
SF-20R/L-2.5D-C25	○	20	25	115	50	50	XCMT10T304		
SF-10R/L-3.25D-C16	○	10	16	85.5	32.5	42	XCMT 050204	M2.0X5	T6
SF-12R/L-3.25D-C16	○	12	16	95	39	45	XCMT 060204	M2.2X5	
SF-14R/L-3.25D-C16	○	14	16	102.5	45.5	45	XCMT 070304	M2.5X6	T8
SF-16R/L-3.25D-C20	○	16	20	114	52	50	XCMT 080304	M3.0X8	T10
SF-20R/L-3.25D-C25	○	20	25	127	65	50	XCMT 10T304		

● Stok ürün - Stock item





○ Stok dışı ürün - Non Stock item

△ Özel Sipariş - Special order





## RAPID DRILL / RAPID DRILL

## Delme Ucu Kodlama Sistemi / Drilling Insert Coding System

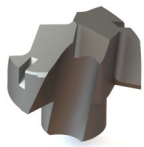
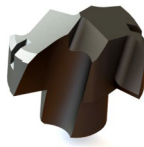

1 ED 2 5 0 ES1	2 3 4 ED 2 5 0 ES1	5 ED 2 5 0 ES1
ED: E-Drill	Matkap Çapı 25,0 mm Drilling Dia.	ES1:  EB:  EA:  EF: 

## Rapid Drill Uçlar İçin Uç Seçim Tablosu / Insert Selection Table For Rapid Drill Inserts(8-26 mm)

Tip Type	Kaliteler Grades	Şekil Form	Uygulama Application
ES1	TP2630 TP4630		Standart uç, çoğu konvansiyonel çelik, orta ve yüksek karbonlu çelikler ile alaşımlı çelikler için uygundur. Ayrıca işleme boyunun 5D'den kısa olduğu durumlarda sfero (nodüler) dökme demir için de kullanılabilir.  Standard insert suitable for most conventional steels, medium and high carbon steel, alloyed steel. Can also be used for nodular cast iron in cases where worklength is shorter than 5D.
ES2	TP2630		Dökme demir delme işlemleri için önerilir. Recommended for cast iron drilling.
EA	TP2630		Standart uç, çoğu konvansiyonel çelik, orta ve yüksek karbonlu çelikler ile alaşımlı çelikler için uygundur. Özellikle 5D'den daha uzun işleme boylarında yüksek rijitlik ve iyi merkezleme özelliği sunar.  Standard insert suitable for most conventional steels, medium and high carbon steel, alloyed steel. Has good rigidity and centering function especially for larger worklengths than 5D.
EB	TP2630		Özgün tasarımı sayesinde mükemmel talaş tahliye performansı sağlar. Ø14 mm'den büyük delik çapları ve 5D / 8D / 12D gibi uzun delme boyları için ilk tercihtir. Paslanmaz çelik, titanyum, nikel bazlı alaşımlar ve manganlı çelikler gibi zor işlenen malzemeler için önerilir.  Has excellent chip removal ability due to its unique design. First choice for hole diameters larger than 14mm and large worklengths like 5D/8D/12D. Suggested for difficult-to-cut materials like stainless steel, titanium, nickel base alloys, manganese steel.
EF	TP2630		Kör delikler ve geçme delikler dahil olmak üzere; çelik ve dökme demir gibi geniş bir malzeme grubunda kullanılabilir.  Can be used for blind holes as well as regular holes for wide range of materials like steel and cast iron.

## RAPID DRILL / RAPID DRILL

### Kolay Bağlama Sistemi / Easy Clamping System

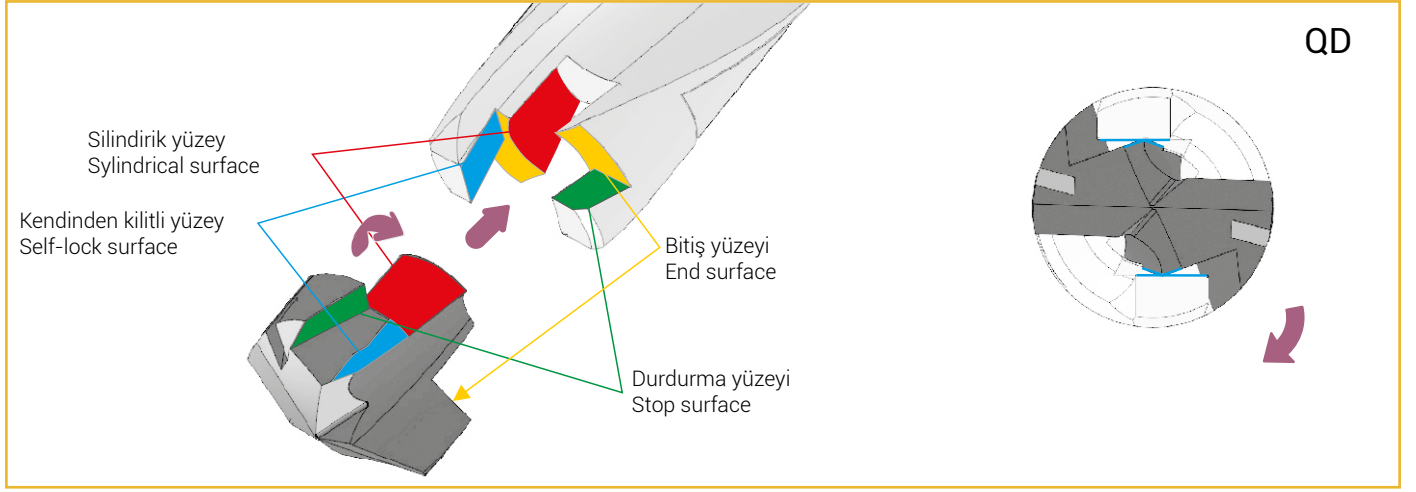

### Cilalanmış Takım Tutucular / Polished Toolholders

Cilalanmış takım tutucu, talaşların kolayca tahliye edilmesini sağlar.

Polished toolholder flutes let chips evacuate easily.



### Soğutma Delikli Takım Tutucular / Toolholders with Coolant Holes

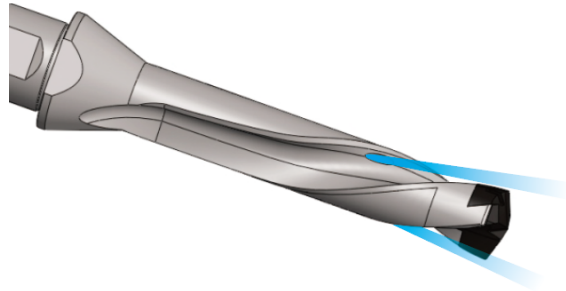

Soğutma sıvısı kullanımı kesici uç ömrünü uzatır. Ayrıca basınç sayesinde talaşlar hızlı bir şekilde tahliye olur.

Usage of coolant helps to sustain longer insert tool life. Also thanks to the pressure, chips are evacuated easily.

### Değiştirilebilirlik ve Esneklik / Interchangeability and Flexibility

Farklı ölçüdeki kesici uçlar aynı tutucuda kullanılabildiği için Euroloy Rapid Drill işletmelere çok daha ekonomik bir çözüm sunar.

Different inserts can be used with a single toolholder. This makes Euroloy Rapid Drills an economic solution for workshops.

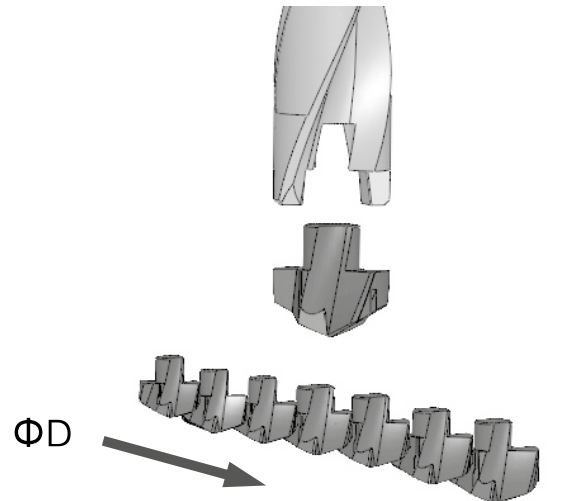

## RAPID DRILL / RAPID DRILL

**Kesici Uçlar Nasıl Takılır? / How to Attach Cutting Inserts?**

- 1**



Ucun konulacağı yeri hava ile temizleyin.  
Remove dust using air blast.
- 2**



Takımın üzerine ucu yerleştirin.  
Put the insert onto drill holder.
- 3**



Ucu saat yönünde hafifçe döndürün. (Elinizi herhangi bir tehlikeden korumak için eldiven kullanın.)  
Turn insert lightly in a clockwise direction (Use gloves to protect your hand from any danger.)
- 4**



Anahtarın kesici ucun yuvasına oturduğundan emin olun.  
Make sure the wrench fits with insert's slot for the wrench.
- 5**



Kesici uç sabitlenene kadar anahtarı yavaşça saat yönünde çevirin.  
Turn the wrench in a clockwise direction slowly until insert won't move.
- 6**



Bağlanmış.  
Completed.

**Kesici Uçlar Nasıl Çıkarılır? / How to Detach Cutting Inserts?**

- 1**



Ucun konulacağı yeri hava ile temizleyin.  
Remove dust using air blast.
- 2**



Ucun üstüne anahtarı yerleştirin.  
Put the wrench onto the insert.
- 3**



Anahtarı saat yönünün tersine hafifçe döndürün.  
Turn insert lightly counter clockwise direction.

## RAPID DRILL / RAPID DRILL

### Soğutma Sıvısı / Coolant

1

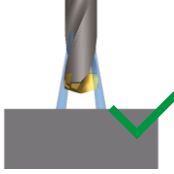

İçerden soğutma sıvısı kullanmanız tavsiye edilir.

Strongly recommended to use inner coolant.

2

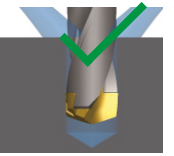

Eğer sadece dışarıdan soğutma kullanacaksanız, delikleri 3D'den daha az bir derinlikte delinir.

If only outer coolant, just drill holes for less than 3D

3

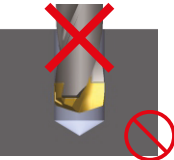

Kuru işleme tavsiye edilmez.

Dry drilling is not recommended.

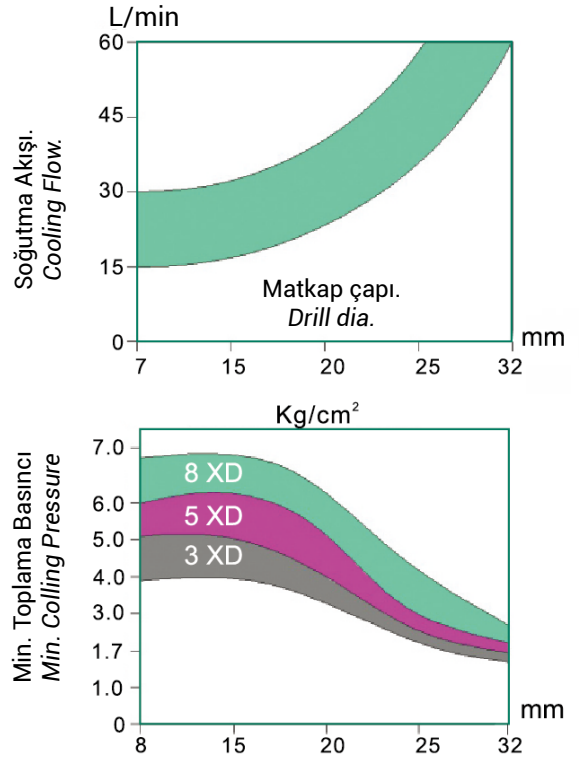

### Çekirdek Sapması Kullanımı İçin Dikkat Edilmesi Gerekenler / Usage Precautions Core Deviation

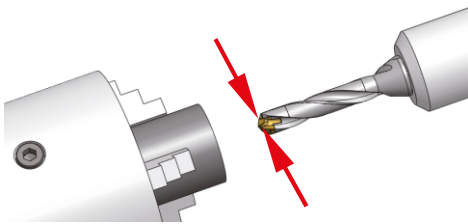

İş parçası ile matkap arasında 0,02mm'nin altında sapma miktarı ayarlayınız.

Set deviation amount under 0,02mm between the workpiece and the drill.

Deforme olmuş bir takma yüzeyi olan herhangi bir şaft kullanmayınız. Şaftın merkezi sapması 0,02mm içinde olmalıdır.

Do not use any arbor with a deformed attachment surface. Center of arbor deviation must be within 0,02mm.

Max. 0.02mm

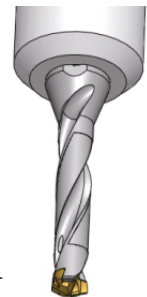
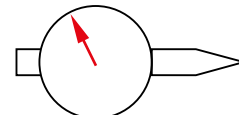

RAPID DRILL / RAPID DRILL

**Kesici Ucun Aşınma Belirtileri / Indication of Insert Wear**

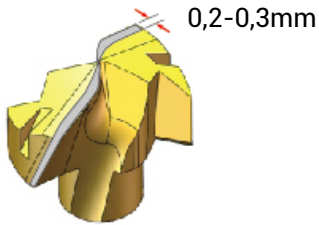

a) Aşınma Sınırı  
Wear Limit

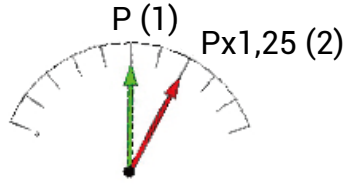

b) Güç Kısıtlaması  
Power Restriction

- 1) Kullanılmamış kesici uç
- 1) New insert
- 2) Aşınmış uç için %25 arttırın
- 2) Increase 25% for worn-out insert

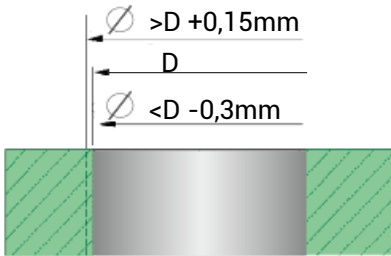

c) Çap değişikliği  
Diameter change

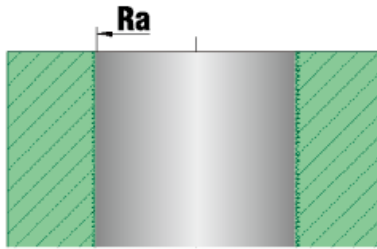

d) Yüzey kalitesinin bozulması  
Surface finish deterioration



e) Titreşim gürültüsü ciddi şekilde artar  
Vibration noise drastically increases

**Kesici Uç Aşınma Belirtileri / Indication of Insert Wear**

Doğru Uygulama Correct Application	İş Parçası Şekli Workpiece Shape	Hatalı Uygulama Incorrect Application	İş Parçası Şekli Workpiece Shape
Düz yüzey Flat face		Delik genişletme önerilmez. Hole expansion not	
Üstüste hizalanmış işparçaları Stacked plates		Eğimli yüzey önerilmez. Slanted surface not	
İçbükey yüzey (ilerleme hızının yarısını azaltmak normaldir.) Concave surface (reduce a half of feed rate is normal.)		Yarım silindirik şekil önerilmez. Half cylindrical not	
Boru malzemesi Pipe material		Çekirdekli delik önerilmez. Cored hole not	

## RAPID DRILL / RAPID DRILL

## MONO UÇ TEKNİK BİLGİ / MONO INSERT TECHNICAL INFORMATION

ISO	Materyal Materials	Isı Tedavisi Heat Treatment	Çizim Kuvveti (Kn/mm2) Drawing Force	Sertlik (HB) Hardness	Kesme Hızı Vc(m/min) Cutting Speed	Feed Rater (mm/rev)						
						D<10	D=10-11.9	D=12-13.9	D=14-15.9	D=16-19.9	D=20-25.9	
P	Alaşimsız Çelik Unalloyed Steel Dökme Demir Cast Iron Otomat Çeliği Free Cutting Steel	<0,25%C Tavlı / Annealed	420	125	80-140							
		>=0,25%C Tavlı / Annealed	650	190	80-130	0,12	0,15	0,18	0,20	0,25	0,25	
		<0,55%C Tavlama Ve Temperleme Tavlama ve Temperleme Annealing And Tempering	850	250	80-120	0,17	0,21	0,24	0,27	0,35	0,35	
		Tavlama ve Temperleme Annealing And Tempering	750	220	70-110	0,22	0,28	0,30	0,35	0,45	0,45	
		Tavlama ve Temperleme Annealing And Tempering	1000	300	50-90							
	Düşük Karbonlu Çelik Dökme Demir (Alaşım bileşimi <5%) Low Carbon Steel Cast Iron (Alloy composition<5%)	Tavlı / Annealed	600	200	70-120							
		tavlama ve temperleme annealing and tempering	930	275	70-110	0,12	0,14	0,16	0,18	0,23	0,25	
			1000	300	50-90	0,18	0,21	0,24	0,26	0,31	0,35	
			1200	350	40-70	0,25	0,28	0,32	0,35	0,40	0,45	
	Yüksek Alaşımli Çelik, Dökme Demir High Alloy Steel, Cast Iron	Tavlı / Annealed	680	200	50-90	0,12	0,12	0,15	0,18	0,20	0,22	
Tavlama ve Temperleme		110	325	40-80	0,16	0,17	0,20	0,23	0,25	0,27		
M	Paslanmaz Çelik Dökme Demir Stainless Steel Cast Iron	Ferritik / Martensit Ferritic / Martensite	680	200	40-70	0,20	0,22	0,25	0,28	0,30	0,33	
		Martensit / Martensite	820	240	40-70	0,10	0,12	0,14	0,16	0,16	0,18	
		Austenitik / Östenitik	600	180	30-70	0,12	0,15	0,17	0,20	0,21	0,24	
K	Gri Dökme Demir Gray Cast Iron	Ferritik / Ferritic		160	90-160							
		Perlitik / Pearlitic		250	80-140							
	Nodüler SG Demir Nodular SG Iron	Ferritik / Ferritic		180	90-180	0,15	0,18	0,20	0,24	0,26	0,30	
		Perlitik / Pearlitic		260	80-140	0,15	0,20	0,25	0,30	0,35	0,35	
	Dövülebilir Dökme Demir Malleable Cast Iron	Ferritik / Ferritic		130	90-160	0,22	0,27	0,32	0,37	0,45	0,37	
	Perlitik / Pearlitic		230	80-140	0,30	0,35	0,40	0,45	0,55	0,60		
N	Dökme Alüminyum Alaşım Cast Aluminium Alloy	Güçlendirme Yok Unsolidification		60	90-220							
		Güçlendirilmiş Solidification		100	90-220							
	Dökme Alüminyum Alaşım Cast Aluminium Alloy	<=12%Si Güçlendirme Yok Unsolidification		75	90-220							
		Güçlendirilmiş Solidification		90	90-220	0,20	0,25	0,30	0,35	0,40	0,45	
	Bakır Alaşımı Copper Alloy	>12%Si Yüksek Sıcaklık Tedavisi		130	80-160	0,27	0,32	0,37	0,42	0,50	0,57	
		>1%Pb Serbest Kesim / Free Cutting		110	90-220	0,35	0,40	0,45	0,50	0,60	0,70	
S	Yüksek sıcaklık Alaşım High Temperature Alloys	Demir Taban Iron-Base	Annealed / Tavllanmış		30-60							
			Güçlendirilmiş Solidification		200	20-50	0,06	0,08	0,10	0,12	0,12	0,14
		Nikel Bazlı Nickelbas e	Annealed / Tavllanmış		280	20-50	0,08	0,10	0,12	0,15	0,16	0,18
			Güçlendirilmiş Solidification		250	20-50	0,11	0,13	0,15	0,18	0,20	0,22
		Kobalt Tabanı Döküm		350	20-50	0,06	0,08	0,10	0,12	0,14	0,16	
	Titanium, Titanium Alaşım Titanium, Titanium Alloys		Rm400	320	20-50	0,09	0,11	0,14	0,16	0,18	0,20	
		α + β	RM1050		20-50	0,12	0,15	0,18	0,20	0,22	0,25	
	H	Sert Çelik Hard Steel	Sertlik Hardness		55HRC	20-50	0,06	0,08	0,10	0,12	0,14	0,16
			Sertleşmek Harden		60HRC	20-50	0,09	0,11	0,14	0,16	0,18	0,20
							0,12	0,15	0,18	0,20	0,22	0,25

8D ve 12D takım tutucular için daha düşük kesme hızı ve ilerleme kullanılmalıdır.  
Lower cutting speed and feed rate should be used for tool holders of 8D and 12D.

## RAPID DRILL / RAPID DRILL

## ES1 STANDART KESİCİ UÇ / ES1 STANDARD CUTTING INSERT

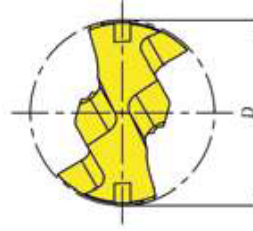
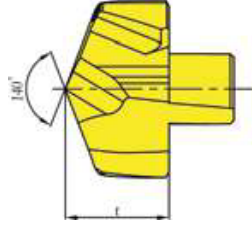

Uç Kodu Insert Code	Boyutlar Dimensions(mm)		Tutucu Kodu Holder Code
	D	t	
ED-080-ES1	8,0	5,4	ED080/089-12-..D-..
ED-081-ES1	8,1	5,4	
ED-082-ES1	8,2	5,4	
ED-083-ES1	8,3	5,4	
ED-084-ES1	8,4	5,4	
ED-083-ES1	8,5	5,4	
ED-086-ES1	8,6	5,4	
ED-087-ES1	8,7	5,4	
ED-088-ES1	8,8	5,4	
ED-089-ES1	8,9	5,4	
ED-090-ES1	9,0	5,8	ED090/099-12-..D-..
ED-091-ES1	9,1	5,8	
ED-092-ES1	9,2	18,0	
ED-093-ES1	9,3	5,8	
ED-094-ES1	9,4	18,0	
ED-095-ES1	9,3	18,0	
ED-096-ES1	9,6	5,8	
ED-097-ES1	9,7	18,0	
ED-098-ES1	9,8	5,8	
ED-099-ES1	9,9	18,0	
ED-100-ES1	10,0	6,2	ED100/109-16-..D-..
ED-101-ES1	10,1	6,2	
ED-102-ES1	10,2	6,2	
ED-103-ES1	10,3	6,2	
ED-104-ES1	10,4	6,2	
ED-105-ES1	10,5	6,2	
ED-106-ES1	10,6	6,2	
ED-107-51	10,7	6,2	
ED-108-ES1	10,8	6,2	
ED-109-ES1	10,9	6,2	

Uç Kodu Insert Code	Boyutlar Dimensions(mm)		Tutucu Kodu Holder Code
	D	t	
ED-110-ES1	11,0	6,6	ED110/119-16-..D-..
ED-111-ES1	11,0	6,6	
ED-112-ES1	11,2	6,6	
ED-113-ES1	11,3	6,6	
ED-114-ES1	11,4	6,6	
ED-115-ES1	11,5	6,6	
ED-116-ES1	11,6	6,6	
ED-117-ES1	11,7	6,6	
ED-118-ES1	11,8	6,6	
ED-119-ES1	11,9	6,6	
ED-120-ES1	12,0	7,0	ED120/129-16-..D-..
ED-121-ES1	12,1	70,0	
ED-122-ES1	12,2	7,0	
ED-123-ES1	12,3	70,0	
ED-124-ES1	12,4	70,0	
ED-125-ES1	12,5	7,0	
ED-126-ES1	12,6	70,0	
ED-127-ES1	12,7	70,0	
ED-128-ES1	12,8	7,0	
ED-129-ES1	12,9	7,0	
ED-130-ES1	13,0	7,6	ED130/139-16-..D-..
ED-131-ES1	13,1	7,6	
ED-132-ES1	13,2	7,6	
ED-133-ES1	13,3	7,6	
ED-134-ES1	13,4	7,6	
ED-135-ES1	13,5	7,6	
ED-136-ES1	13,6	7,6	
ED-137-ES1	13,7	7,6	
ED-138-ES1	13,8	7,6	
ED-139-ES1	13,9	7,6	

Düşük ve yüksek karbonlu çelikler, alaşımli çelikler, nodüler dökme demir (özellikle 5D'den daha küçük olan delme boylarında) ES1 kesici uç önerilir.  
 ES1 insert is recommended for drilling low and high carbon steel, alloy steel, nodular cast iron (specifically for less than 5D).

## RAPID DRILL / RAPID DRILL

## ES1 STANDART KESİCİ UÇ / ES1 STANDARD CUTTING INSERT

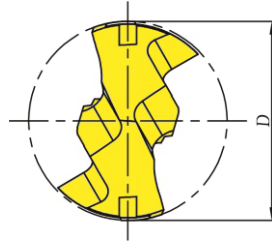
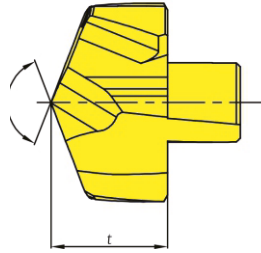
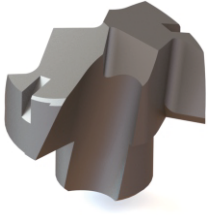

Uç Kodu Insert Code	Boyutlar Dimensions(mm)		Tutucu Kodu Holder Code
	D	t	
ED-140-ES1	14,0	8,1	ED140/149-16-..D-..
ED-141-ES1	14,1	8,1	
ED-142-ES1	14,2	8,1	
ED-143-ES1	14,3	8,1	
ED-144-ES1	14,4	8,1	
ED-145-ES1	14,5	8,1	
ED-146-ES1	14,6	8,1	
ED-147-ES1	14,7	8,1	
ED-148-ES1	14,8	8,1	
ED-149-ES1	14,9	8,1	
ED-150-ES1	15,0	8,7	EDM150/159-20-..D-..
ED-151-ES1	15,1	8,7	
ED-152-ES1	15,2	8,7	
ED-153-ES1	15,3	8,7	
ED-154-ES1	15,4	8,7	
ED-155-ES1	15,5	8,7	
ED-156-ES1	15,6	8,7	
ED-157-ES1	15,7	8,7	
ED-158-ES1	15,8	8,7	
ED-159-ES1	15,9	8,7	
ED-160-ES1	16,0	9,3	ED160/169-20- D-..
ED-161-ES1	16,1	9,3	
ED-162-ES1	16,2	9,3	
ED-163-ES1	16,3	9,3	
ED-164-ES1	16,4	9,3	
ED-165-ES1	16,5	93,0	
ED-166-ES1	16,6	9,3	
ED-167-ES1	16,7	93,0	
ED-168-ES1	16,8	9,3	
ED-169-ES1	16,9	93,0	

Uç Kodu Insert Code	Boyutlar Dimensions(mm)		Tutucu Kodu Holder Code
	D	t	
ED-170-ES1	17,0	9,9	ED170/179-20-..D-..
ED-171-ES1	17,1	9,9	
ED-172-ES1	17,2	9,9	
ED-173-ES1	17,3	9,9	
ED-174-ES1	17,4	9,9	
ED-175-ES1	17,5	9,9	
ED-176-ES1	17,6	9,9	
ED-177-ES1	17,7	9,9	
ED-178-ES1	17,8	9,9	
ED-179-ES1	17,9	9,9	
ED-180-ES1	18,0	10,5	ED180/189-25-..D-..
ED-181-ES1	18,1	10,5	
ED-182-ES1	18,2	10,5	
ED-183-ES1	18,3	10,5	
ED-184-ES1	18,4	10,5	
ED-185-ES1	18,5	10,5	
ED-186-ES1	18,6	10,5	
ED-187-ES1	18,7	10,5	
ED-188-ES1	18,8	10,3	
ED-189-ES1	18,9	10,3	
ED-190-ES1	19,0	11,0	ED190/199-25- D-..
ED-191-ES1	19,1	11,0	
ED-192-ES1	19,2	11,0	
ED-193-ES1	19,3	11,0	
ED-194-ES1	19,4	11,0	
ED-195-ES1	19,5	11,0	
ED-196-ES1	19,6	11,0	
ED-197-ES1	19,7	11,0	
ED-198-ES1	19,8	11,0	
ED-199-ES1	19,9	11,0	

Orta ve yüksek karbonlu çelik, alaşım çeliği ve nodüler dökme demir (özellikle 5D'den daha az olanlar için) için ES1 kesici uç kullanılmasını öneririm.  
*Recommended ES1 cutting insert to be used for middle and high carbon steel, alloy steel, nodular cast iron (speciallu for less than 5D)*

## RAPID DRILL / RAPID DRILL

## ES1 STANDART KESİCİ UÇ / ES1 STANDARD CUTTING INSERT

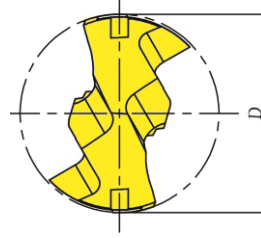
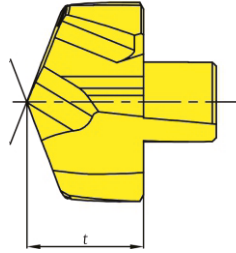
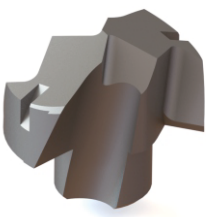

Uç Kodu Insert Code	Boyutlar Dimensions(mm)		Tutucu Kodu Holder Code
	D	t	
ED-200-ES1	20,0	11,6	ED200/209-25-..D-..
ED-201-ES1	20,1	11,6	
ED-202-ES1	20,2	11,6	
ED-203-ES1	20,3	11,6	
ED-204-ES1	20,4	11,6	
ED-205-ES1	20,5	11,6	
ED-206-ES1	20,6	11,6	
ED-207-ES1	20,7	11,6	
ED-208-ES1	20,8	11,6	
ED-209-ES1	20,9	11,6	
ED-210-ES1	21,0	12,1	ED210/219-25-..D-..
ED-211-ES1	21,1	12,1	
ED-212-ES1	21,2	12,1	
ED-213-ES1	21,3	12,1	
ED-214-ES1	21,4	12,1	
ED-215-ES1	21,5	12,1	
ED-216-ES1	21,6	12,1	
ED-217-ES1	21,7	12,1	
ED-218-ES1	21,8	12,1	
ED-219-ES1	21,9	12,1	
ED-220-ES1	22,0	12,7	ED220/229-25-..D-..
ED-221-ES1	22,1	127,0	
ED-222-ES1	22,2	12,7	
ED-223-ES1	22,3	12,7	
ED-224-ES1	22,4	12,7	
ED-225-ES1	22,5	127,0	
ED-226-ES1	22,6	12,7	
ED-227-ES1	22,7	12,7	
ED-228-ES1	22,8	12,7	
ED-229-ES1	22,9	12,7	

Uç Kodu Insert Code	Boyutlar Dimensions(mm)		Tutucu Kodu Holder Code
	D	t	
ED-230-ES1	23,0	13,3	ED230/239-32-..D-..
ED-231-ES1	23,1	13,3	
ED-232-ES1	23,2	13,3	
ED-233-ES1	23,3	13,3	
ED-234-ES1	23,4	13,3	
ED-235-ES1	23,5	13,3	
ED-236-ES1	23,6	13,3	
ED-237-ES1	23,7	13,3	
ED-238-ES1	23,8	13,3	
ED-239-ES1	23,9	13,3	
ED-240-ES1	24,0	13,9	ED240/249-32-..D-..
ED-241-ES1	24,1	13,9	
ED-242-ES1	24,2	13,9	
ED-243-ES1	24,3	13,9	
ED-244-ES1	24,4	13,9	
ED-245-ES1	24,5	13,9	
ED-246-ES1	24,6	13,9	
ED-247-ES1	24,7	13,9	
ED-248-ES1	24,8	13,9	
ED-249-ES1	24,9	13,9	
ED-250-ES1	25,0	14,5	ED250/260-32-..D-..
ED-251-ES1	25,1	14,5	
ED-252-ES1	25,2	14,5	
ED-253-ES1	25,3	14,5	
ED-254-ES1	25,4	14,5	
ED-255-ES1	25,5	14,5	
ED-256-ES1	25,6	14,5	
ED-257-ES1	25,7	14,5	
ED-258-ES1	25,8	14,5	
ED-259-ES1	25,9	14,5	
ED-260-ES1	26,0	14,5	

## RAPID DRILL / RAPID DRILL

### ED... ES2 STANDART KESİCİ UÇ / ED... ES2 STANDARD CUTTING INSERT

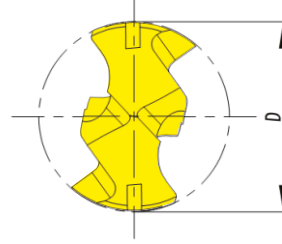
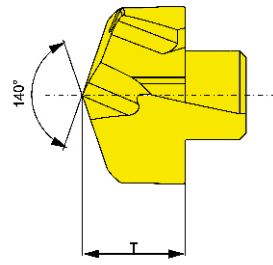
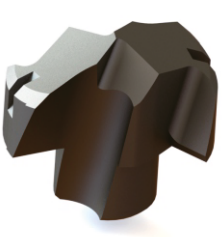

Uç Kodu Insert Code	Boyutlar Dimensions(mm)		Tutucu Kodu Holder Code
	D	t	
ED-080-ES2	8,0	5,4	ED080/089-12-..D-..
ED-081-ES2	8,1	5,4	
ED-082-ES2	8,2	5,4	
ED-083-ES2	8,3	5,4	
ED-084-ES2	8,4	5,4	
ED-085-ES2	8,5	5,4	
ED-086-ES2	8,6	5,4	
ED-087-ES2	8,7	5,4	
ED-088-ES2	8,8	5,4	
ED-089-ES2	8,9	5,4	
ED-090-ES2	9,0	5,8	ED090/099-12-..D-..
ED-091-ES2	9,1	5,8	
ED-092-ES2	9,2	5,8	
ED-093-ES2	9,3	5,8	
ED-094-ES2	9,4	5,8	
ED-095-ES2	9,5	5,8	
ED-096-ES2	9,6	5,8	
ED-097-ES2	9,7	5,8	
ED-098-ES2	9,8	5,8	
ED-099-ES2	9,9	5,8	
ED-100-ES2	10,0	6,2	ED100/109-16-..D-..
ED-101-ES2	10,1	6,2	
ED-102-ES2	10,2	6,2	
ED-103-ES2	10,3	6,2	
ED-104-ES2	10,4	6,2	
ED-105-ES2	10,5	6,2	
ED-106-ES2	10,6	6,2	
ED-107-ES2	10,7	6,2	
ED-108-ES2	10,8	6,2	
ED-109-ES2	10,9	6,2	

Uç Kodu Insert Code	Boyutlar Dimensions(mm)		Tutucu Kodu Holder Code
	D	t	
ED-110-ES2	11,0	6,6	ED110/119-16-..D-..
ED-111-ES2	11,1	6,6	
ED-112-ES2	11,2	6,6	
ED-113-ES2	11,3	6,6	
ED-114-ES2	11,4	6,6	
ED-115-ES2	11,5	6,6	
ED-116-ES2	11,6	6,6	
ED-117-ES2	11,7	6,6	
ED-118-ES2	11,8	6,6	
ED-119-ES2	11,9	6,6	
ED-120-ES2	12,0	7,0	ED120/129-16-..D-..
ED-121-ES2	12,1	7,0	
ED-122-ES2	12,2	7,0	
ED-123-ES2	12,3	7,0	
ED-124-ES2	12,4	7,0	
ED-125-ES2	12,5	7,0	
ED-126-ES2	12,6	7,0	
ED-127-ES2	12,7	7,0	
ED-128-ES2	12,8	7,0	
ED-129-ES2	12,9	7,0	
ED-130-ES2	13,0	7,6	ED130/139-16-..D-..
ED-131-ES2	13,1	7,6	
ED-132-ES2	13,2	7,6	
ED-133-ES2	13,3	7,6	
ED-134-ES2	13,4	7,6	
ED-135-ES2	13,5	7,6	
ED-136-ES2	13,6	7,6	
ED-137-ES2	13,7	7,6	
ED-138-ES2	13,8	7,6	
ED-139-ES2	13,9	7,6	

Gri dökme demir ve nodüler dökme demir malzeme işlemede ES2 karbür uç tavsiye edilir.

For machining gray cast iron and nodular cast iron, ES2 cutting insert is recommended.

## RAPID DRILL / RAPID DRILL

## ED... ES2 STANDART KESİCİ UÇ / ED... ES2 STANDARD CUTTING INSERT

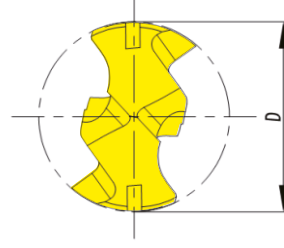
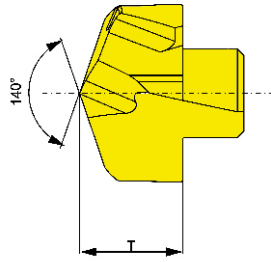
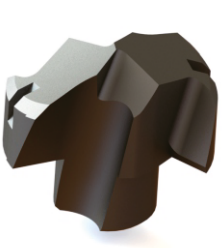

Uç Kodu Insert Code	Boyutlar Dimensions(mm)		Tutucu Kodu Holder Code
	D	t	
ED-140-ES2	14,0	8,1	ED140/149-16-..D-..
ED-141-ES2	14,1	8,1	
ED-143-ES2	14,2	8,1	
ED-144-ES2	14,3	8,1	
ED-145-ES2	14,4	8,1	
ED-146-ES2	14,5	8,1	
ED-147-ES2	14,6	8,1	
ED-148-ES2	14,7	8,1	
ED-149-ES2	14,8	8,1	
ED-150-ES2	14,9	8,1	
ED-151-ES2	15,0	8,7	EDM150/159-20-..D-..
ED-152-ES2	15,1	8,7	
ED-153-ES2	15,2	8,7	
ED-154-ES2	15,3	8,7	
ED-155-ES2	15,4	8,7	
ED-156-ES2	15,5	8,7	
ED-157-ES2	15,6	8,7	
ED-158-ES2	15,7	8,7	
ED-159-ES2	15,8	8,7	
ED-160-ES2	15,9	8,7	
ED-161-ES2	16,0	9,3	ED160/169-20- D-..
ED-162-ES2	16,1	9,3	
ED-163-ES2	16,2	9,3	
ED-164-ES2	16,3	9,3	
ED-165-ES2	16,4	9,3	
ED-166-ES2	16,5	9,3	
ED-167-ES2	16,6	9,3	
ED-168-ES2	16,7	9,3	
ED-169-ES2	16,8	9,3	
ED-170-ES2	16,9	9,3	

Uç Kodu Insert Code	Boyutlar Dimensions(mm)		Tutucu Kodu Holder Code
	D	t	
ED-170-ES2	17,0	9,9	ED170/179-20-..D-..
ED-171-ES2	17,1	9,9	
ED-172-ES2	17,2	9,9	
ED-173-ES2	17,3	9,9	
ED-174-ES2	17,4	9,9	
ED-175-ES2	17,5	9,9	
ED-176-ES2	17,6	9,9	
ED-177-ES2	17,7	9,9	
ED-178-ES2	17,8	9,9	
ED-179-ES2	17,9	9,9	
ED-180-ES2	18,0	10,5	ED180/189-25-..D-..
ED-181-ES2	18,1	10,5	
ED-182-ES2	18,2	10,5	
ED-183-ES2	18,3	10,5	
ED-184-ES2	18,4	10,5	
ED-185-ES2	18,5	10,5	
ED-186-ES2	18,6	10,5	
ED-187-ES2	18,7	10,5	
ED-188-ES2	18,8	10,5	
ED-189-ES2	18,9	10,5	
ED-190-ES2	19,0	11,0	ED190/199-25- D-..
ED-191-ES2	19,1	11,0	
ED-192-ES2	19,2	11,0	
ED-193-ES2	19,3	11,0	
ED-194-ES2	19,4	11,0	
ED-195-ES2	19,5	11,0	
ED-196-ES2	19,6	11,0	
ED-197-ES2	19,7	11,0	
ED-198-ES2	19,8	11,0	
ED-199-ES2	19,9	11,0	

Gri dökme demir ve nodüler dökme demir malzeme işlemede ES2 karbür uç tavsiye edilir.

For machining gray cast iron and nodular cast iron, ES2 cutting insert is recommended.

## RAPID DRILL / RAPID DRILL

### ED... ES2 STANDART KESİCİ UÇ / ED... ES2 STANDARD CUTTING INSERT

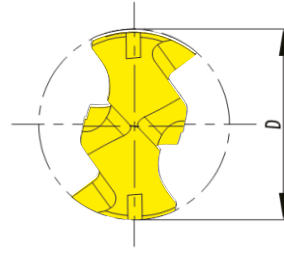
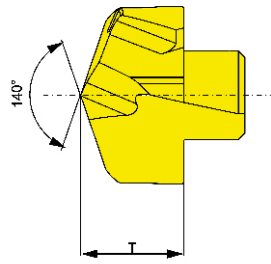
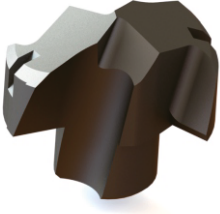

Uç Kodu Insert Code	Boyutlar Dimensions(mm)		Tutucu Kodu Holder Code
	D	t	
ED-200-ES2	20,0	11,6	ED200/209-25-..D-..
ED-201-ES2	20,1	11,6	
ED-202-ES2	20,2	11,6	
ED-203-ES2	20,3	11,6	
ED-204-ES2	20,4	11,6	
ED-205-ES2	20,5	11,6	
ED-206-ES2	20,6	11,6	
ED-207-ES2	20,7	11,6	
ED-208-ES2	20,8	11,6	
ED-209-ES2	20,9	11,6	
ED-210-ES2	21,0	12,1	ED210/291-25-..D-..
ED-211-ES2	21,1	12,1	
ED-212-ES2	21,2	12,1	
ED-213-ES2	21,3	12,1	
ED-214-ES2	21,4	12,1	
ED-215-ES2	21,5	12,1	
ED-216-ES2	21,6	12,1	
ED-217-ES2	21,7	12,1	
ED-218-ES2	21,8	12,1	
ED-219-ES2	21,9	12,1	
ED-220-ES2	22,0	12,7	ED220/229-25-..D-..
ED-221-ES2	22,1	12,7	
ED-222-ES2	22,2	12,7	
ED-223-ES2	22,3	12,7	
ED-224-ES2	22,4	12,7	
ED-225-ES2	22,5	12,7	
ED-226-ES2	22,6	12,7	
ED-227-ES2	22,7	12,7	
ED-228-ES2	22,8	12,7	
ED-229-ES2	22,9	12,7	

Uç Kodu Insert Code	Boyutlar Dimensions(mm)		Tutucu Kodu Holder Code
	D	t	
ED-230-ES2	23,0	13,3	ED230/239-32-..D-..
ED-231-ES2	23,1	13,3	
ED-232-ES2	23,2	13,3	
ED-233-ES2	23,3	13,3	
ED-234-ES2	23,4	13,3	
ED-235-ES2	23,5	13,3	
ED-236-ES2	23,6	13,3	
ED-237-ES2	23,7	13,3	
ED-238-ES2	23,8	13,3	
ED-239-ES2	23,9	13,3	
ED-240-ES2	24,0	13,9	ED240/249-32-..D-..
ED-241-ES2	24,1	13,9	
ED-242-ES2	24,2	13,9	
ED-243-ES2	24,3	13,9	
ED-244-ES2	24,4	13,9	
ED-245-ES2	24,5	13,9	
ED-246-ES2	24,6	13,9	
ED-247-ES2	24,7	13,9	
ED-248-ES2	24,8	13,9	
ED-249-ES2	24,9	13,9	
ED-250-ES2	25,0	14,5	ED250/260-32-..D-..
ED-251-ES2	25,1	14,5	
ED-252-ES2	25,2	14,5	
ED-253-ES2	25,3	14,5	
ED-254-ES2	25,4	14,5	
ED-255-ES2	25,5	14,5	
ED-256-ES2	25,6	14,5	
ED-257-ES2	25,7	14,5	
ED-258-ES2	25,8	14,5	
ED-259-ES2	25,9	14,5	
ED-260-ES2	26,0	14,5	

## RAPID DRILL / RAPID DRILL

## ED... EA ÖZEL KESİCİ UÇ / ED... EA SPECIAL CUTTING INSERT

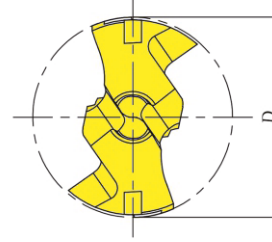
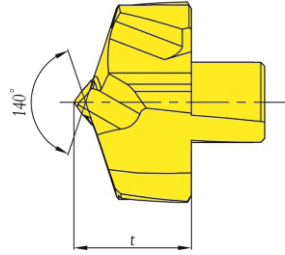
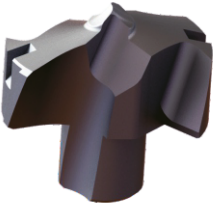

Uç Kodu Insert Code	Boyutlar Dimensions(mm)		Tutucu Kodu Holder Code
	D	t	
ED-080-EA	8,0	5,4	ED080/089-12-..D-..
ED-081-EA	8,1	5,4	
ED-082-EA	8,2	5,4	
ED-083-EA	8,3	5,4	
ED-084-EA	8,4	5,4	
ED-085-EA	8,5	5,4	
ED-086-EA	8,6	5,4	
ED-087-EA	8,7	5,4	
ED-088-EA	8,8	5,4	
ED-089-EA	8,9	5,4	
ED-090-EA	9,0	5,8	ED090/099-12-..D-..
ED-091-EA	9,1	5,8	
ED-092-EA	9,2	5,8	
ED-093-EA	9,3	5,8	
ED-094-EA	9,4	5,8	
ED-095-EA	9,5	5,8	
ED-096-EA	9,6	5,8	
ED-097-EA	9,7	5,8	
ED-098-EA	9,8	5,8	
ED-099-EA	9,9	5,8	
ED-100-EA	10,0	6,2	ED100/109-16-..D-..
ED-101-EA	10,1	6,2	
ED-102-EA	10,2	6,2	
ED-103-EA	10,3	6,2	
ED-104-EA	10,4	6,2	
ED-105-EA	10,5	6,2	
ED-106-EA	10,6	6,2	
ED-107-EA	10,7	6,2	
ED-108-EA	10,8	6,2	
ED-109-EA	10,9	6,2	

Uç Kodu Insert Code	Boyutlar Dimensions(mm)		Tutucu Kodu Holder Code
	D	t	
ED-110-EA	11,0	6,6	ED110/119-16-..D-..
ED-111-EA	11,1	6,6	
ED-112-EA	11,2	6,6	
ED-113-EA	11,3	6,6	
ED-114-EA	11,4	6,6	
ED-115-EA	11,5	6,6	
ED-116-EA	11,6	6,6	
ED-117-EA	11,7	6,6	
ED-118-EA	11,8	6,6	
ED-119-EA	11,9	6,6	
ED-120-EA	12,0	7,0	ED120/129-16-..D-..
ED-121-EA	12,1	7,0	
ED-122-EA	12,2	7,0	
ED-123-EA	12,3	7,0	
ED-124-EA	12,4	7,0	
ED-125-EA	12,5	7,0	
ED-126-EA	12,6	7,0	
ED-127-EA	12,7	7,0	
ED-128-EA	12,8	7,0	
ED-129-EA	12,9	7,0	
ED-130-EA	13,0	7,6	ED130/139-16-..D-..
ED-131-EA	13,1	7,6	
ED-132-EA	13,2	7,6	
ED-133-EA	13,3	7,6	
ED-134-EA	13,4	7,6	
ED-135-EA	13,5	7,6	
ED-136-EA	13,6	7,6	
ED-137-EA	13,7	7,6	
ED-138-EA	13,8	7,6	
ED-139-EA	13,9	7,6	

İnovatif geometri tasarımı sayesinde EA uçlar çok iyi merkezleme özelliğine sahiptir. Düşük ve yüksek karbonlu çelikler ve alaşımlı çeliklerde (özellikle 5D üzeri) tavsiye edilir. *With its innovative geometry design, EA insert ensures excellent holde positioning through its self-centering point. EA insert can be used for machining low and high carbon steel, alloy steel (especially for more than 5D).*

## RAPID DRILL / RAPID DRILL

### ED...EA ÖZEL KESİCİ UÇ / ED...EA SPECIAL CUTTING INSERT

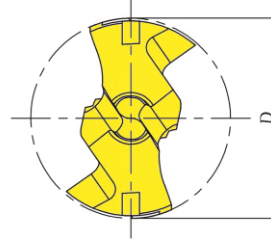
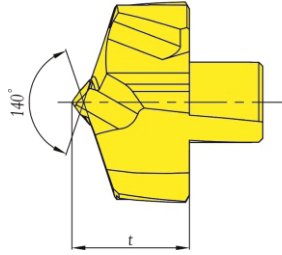

Uç Kodu Insert Code	Boyutlar Dimensions(mm)		Tutucu Kodu Holder Code
	D	t	
ED-140-EA	14,0	8,1	ED140/149-16-..D-..
ED-141-EA	14,1	8,1	
ED-142-EA	14,2	8,1	
ED-143-EA	14,3	8,1	
ED-144-EA	14,4	8,1	
ED-145-EA	14,5	8,1	
ED-146-EA	14,6	8,1	
ED-147-EA	14,7	8,1	
ED-148-EA	14,8	8,1	
ED-149-EA	14,9	8,1	
ED-150-EA	15,0	8,7	ED150/159-20-..D-..
ED-151-EA	15,1	8,7	
ED-152-EA	15,2	8,7	
ED-153-EA	15,3	8,7	
ED-154-EA	15,4	8,7	
ED-155-EA	15,5	8,7	
ED-156-EA	15,6	8,7	
ED-157-EA	15,7	8,7	
ED-158-EA	15,8	8,7	
ED-159-EA	15,9	8,7	
ED-160-EA	16,0	9,3	ED160/169-20-..D-..
ED-161-EA	16,1	9,3	
ED-162-EA	16,2	9,3	
ED-163-EA	16,3	9,3	
ED-164-EA	16,4	9,3	
ED-165-EA	16,5	9,3	
ED-166-EA	16,6	9,3	
ED-167-EA	16,7	9,3	
ED-168-EA	16,8	9,3	
ED-169-EA	16,9	9,3	

Uç Kodu Insert Code	Boyutlar Dimensions(mm)		Tutucu Kodu Holder Code
	D	t	
ED-170-EA	17,0	9,9	ED170/179-20-..D-..
ED-171-EA	17,1	9,9	
ED-172-EA	17,2	9,9	
ED-173-EA	17,3	9,9	
ED-174-EA	17,4	9,9	
ED-175-EA	17,5	9,9	
ED-176-EA	17,6	9,9	
ED-177-EA	17,7	9,9	
ED-178-EA	17,8	9,9	
ED-179-EA	17,9	9,9	
ED-180-EA	18,0	10,5	ED180/189-25-..D-..
ED-181-EA	18,1	10,5	
ED-182-EA	18,2	10,5	
ED-183-EA	18,3	10,5	
ED-184-EA	18,4	10,5	
ED-185-EA	18,5	10,5	
ED-186-EA	18,6	10,5	
ED-187-EA	18,7	10,5	
ED-188-EA	18,8	10,5	
ED-189-EA	18,9	10,5	
ED-190-EA	19,0	11,0	ED190/199-25-..D-..
ED-191-EA	19,1	11,0	
ED-192-EA	19,2	11,0	
ED-193-EA	19,3	11,0	
ED-194-EA	19,4	11,0	
ED-195-EA	19,5	11,0	
ED-196-EA	19,6	11,0	
ED-197-EA	19,7	11,0	
ED-198-EA	19,8	11,0	
ED-199-EA	19,9	11,0	

İnovatif geometri tasarımı sayesinde EA uçlar çok iyi merkezleme özelliğine sahiptir. Düşük ve yüksek karbonlu çelikler ve alaşımlı çeliklerde (özellikle 5D üzeri) tavsiye edilir. With its innovative geometry design, EA insert ensures excellent hole positioning through its self-centering point. EA insert can be used for machining low and high carbon steel, alloy steel (especially for more than 5D).

## RAPID DRILL / RAPID DRILL

## ED...EA ÖZEL KESİCİ UÇ / ED...EA SPECIAL CUTTING INSERT

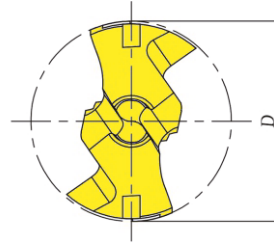
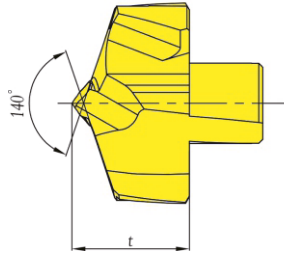
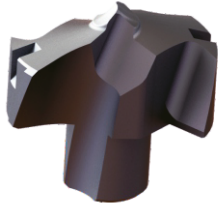

Uç Kodu Insert Code	Boyutlar Dimensions(mm)		Tutucu Kodu Holder Code
	D	t	
ED-200-EA	20,0	11,6	ED200/209-25-..D-..
ED-201-EA	20,1	11,6	
ED-202-EA	20,2	11,6	
ED-203-EA	20,3	11,6	
ED-204-EA	20,4	11,6	
ED-205-EA	20,5	11,6	
ED-206-EA	20,6	11,6	
ED-207-EA	20,7	11,6	
ED-208-EA	20,8	11,6	
ED-209-EA	20,9	11,6	
ED-210-EA	21,0	12,1	ED210/219-25-..D-..
ED-211-EA	21,1	12,1	
ED-212-EA	21,2	12,1	
ED-213-EA	21,3	12,1	
ED-214-EA	21,4	12,1	
ED-215-EA	21,5	12,1	
ED-216-EA	21,6	12,1	
ED-217-EA	21,7	12,1	
ED-218-EA	21,8	12,1	
ED-219-EA	21,9	12,1	
ED-220-EA	22,0	12,7	ED220/229-25-..D-..
ED-221-EA	22,1	12,7	
ED-222-EA	22,2	12,7	
ED-223-EA	22,3	12,7	
ED-224-EA	22,4	12,7	
ED-225-EA	22,5	12,7	
ED-226-EA	22,6	12,7	
ED-227-EA	22,7	12,7	
ED-228-EA	22,8	12,7	
ED-229-EA	22,9	12,7	

Uç Kodu Insert Code	Boyutlar Dimensions(mm)		Tutucu Kodu Holder Code
	D	t	
ED-230-EA	23,0	13,3	ED230/239-32-..D-..
ED-231-EA	23,1	13,3	
ED-232-EA	23,2	13,3	
ED-233-EA	23,3	13,3	
ED-234-EA	23,4	13,3	
ED-235-EA	23,5	13,3	
ED-236-EA	23,6	13,3	
ED-237-EA	23,7	13,3	
ED-238-EA	23,8	13,3	
ED-239-EA	23,9	13,3	
ED-240-EA	24,0	13,9	ED240/249-32-..D-..
ED-241-EA	24,1	13,9	
ED-242-EA	24,2	13,9	
ED-243-EA	24,3	13,9	
ED-244-EA	24,4	13,9	
ED-245-EA	24,5	13,9	
ED-246-EA	24,6	13,9	
ED-247-EA	24,7	13,9	
ED-248-EA	24,8	13,9	
ED-249-EA	24,9	13,9	
ED-250-EA	25,0	14,5	ED250/260-32-..D-..
ED-251-EA	25,1	14,5	
ED-252-EA	25,2	14,5	
ED-253-EA	25,3	14,5	
ED-254-EA	25,4	14,5	
ED-255-EA	25,5	14,5	
ED-256-EA	25,6	14,5	
ED-257-EA	25,7	14,5	
ED-258-EA	25,8	14,5	
ED-259-EA	25,9	14,5	
ED-260-EA	26,0	14,5	

## RAPID DRILL / RAPID DRILL

### ED...EF DÜZ YÜZEY KESİCİ UÇ / ED...EF FLAT SURFACE CUTTING INSERT

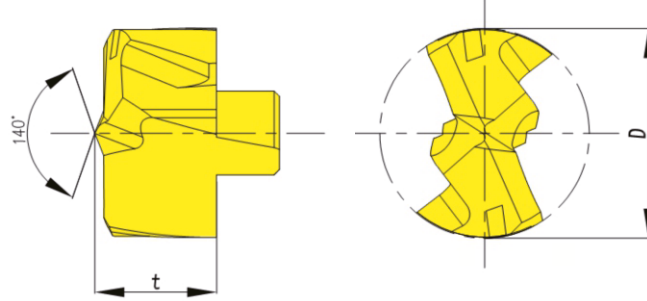
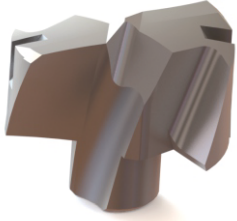

Uç Kodu Insert Code	Boyutlar Dimensions(mm)		Tutucu Kodu Holder Code
	D	t	
ED-080-EF	8,0	4,0	ED080-089-12-..D-..
ED-083-EF	8,5	4,0	
ED-090-EF	9,0	4,2	ED090-099-12-..D-..
ED-095-EF	9,5	4,2	
ED-100-EF	10,0	4,4	ED100-109-16-..D-..
ED-105-EF	10,5	4,4	
ED-110-EF	11,0	4,5	ED110-119-16-..D-..
ED-115-EF	11,5	4,5	
ED-120-EF	12,0	4,8	ED120-129-16-..D-..
ED-125-EF	12,5	4,8	
ED-130-EF	13,0	5,1	ED130-139-16-..D-..
ED-135-EF	13,5	5,1	
ED-140-EF	14,0	5,5	ED140-149-16-..D-..
ED-145-EF	14,5	5,5	
ED-150-EF	15,0	5,9	ED150-159-20-..D-..
ED-153-EF	15,5	5,9	
ED-160-EF	16,0	6,3	ED160-169-20-..D-..
ED-165-EF	16,5	6,3	

Uç Kodu Insert Code	Boyutlar Dimensions(mm)		Tutucu Kodu Holder Code
	D	t	
ED-170-EF	17,0	6,6	ED170-179-20-..D-..
ED-175-EF	17,5	6,6	
ED-180-EF	18,0	6,9	ED180-189-25-..D-..
ED-185-EF	18,5	6,9	
ED-190-EF	19,0	7,2	ED190-199-25-..D-..
ED-195-EF	19,5	7,2	
ED-200-EF	20,0	8,2	ED200-209-25-..D-..
ED-203-EF	20,5	8,2	
ED-210-EF	21,0	8,6	ED210-219-2J-..D-..
ED-215-EF	21,5	8,6	
ED-220-EF	22,0	8,9	ED220-229-23-..D-..
ED-223-EF	22,5	8,9	
ED-230-EF	23,0	9,3	ED230-239-32-..D-..
ED-235-EF	23,5	9,3	
ED-240-EF	24,0	9,7	ED240-249-32-..D-..
ED-245-EF	24,5	9,7	
ED-250-EF	25,0	10,1	ED230-260-?2-..D-..
ED-255-EF	25,5	10,1	
ED-260-EF	26,0	10,1	

EF tipi kesici uç çok çeşitli malzemelerde sıfırdan delik açma için kullanılabilir.  
*EF type inserts can be used for drilling blind flat holes.*

EB uçlar çok iyi merkezleme özelliğine sahiptir ve düşük kesme kuvvetiyle delik delme operasyonlarını tamamlayabilir.  
 Paslanmaz çelik, titanyum, nikel bazlı alaşımlar, mangan çeliği gibi işlenmesi zor malzemeler için tavsiye edilir.

*EB type insert ensures excellent hole positioning through its self-centering point and can drill with low cutting force.  
 EA insert can be used for machining stainless steel, titanium, nickel based alloys, Mn steel.*

## RAPID DRILL / RAPID DRILL

## ED...EB DÜZ YÜZEY KESİCİ UÇ / ED...EB FLAT SURFACE CUTTING INSERT

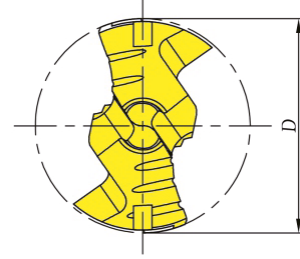
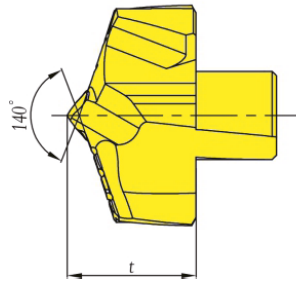
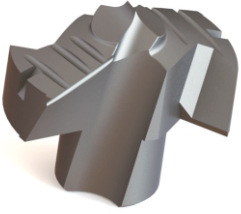

Uç Kodu Insert Code	Boyutlar Dimensions(mm)		Tutucu Kodu Holder Code
	D	t	
ED-080-EB	8	5,4	ED080/089-12-..D-..
ED-081-EB	8,1	5,4	
ED-082-EB	8,2	5,4	
ED-083-EB	8,3	5,4	
ED-084-EB	8,4	5,4	
ED-083-EB	8,5	5,4	
ED-086-EB	8,6	5,4	
ED-087-EB	8,7	5,4	
ED-088-EB	8,8	5,4	
ED-089-EB	8,9	5,4	
ED-090-EB	9	5,8	ED090/099-12-..D-..
ED-091-EB	9,1	5,8	
ED-092-EB	9,2	5,8	
ED-093-EB	9,3	5,8	
ED-094-EB	9,4	5,8	
ED-095-EB	9,5	5,8	
ED-096-EB	9,6	5,8	
ED-097-EB	9,7	5,8	
ED-098-EB	9,8	5,8	
ED-099-EB	9,9	5,8	
ED-100-EB	10	6,2	ED100/109-16-..D-..
ED-101-EB	10,1	6,2	
ED-102-EB	10,2	6,2	
ED-103-EB	10,3	6,2	
ED-104-EB	10,4	6,2	
ED-105-EB	10,5	6,2	
ED106-EB	10,6	6,2	
ED-107-EB	10,7	6,2	
ED108-EB	10,8	6,2	
ED-109-EB	10,9	6,2	

Uç Kodu Insert Code	Boyutlar Dimensions(mm)		Tutucu Kodu Holder Code
	D	t	
ED-110-EB	11,0	6,6	ED110/119-16-..D-..
ED-111-EB	11,1	6,6	
ED-112-EB	11,2	6,6	
ED-113-EB	11,3	6,6	
ED-114-EB	11,3	6,6	
ED-115-EB	11,3	6,6	
ED-116-EB	11,3	6,6	
ED-117-EB	11,3	6,6	
ED-118-EB	11,3	6,6	
ED-119-EB	11,3	6,6	
ED-120-EB	12,0	7,0	ED120/129-16-..D-..
ED-121-EB	12,1	7,0	
ED-122-EB	12,2	7,0	
ED-123-EB	12,3	7,0	
ED-124-EB	12,4	7,0	
ED-125-EB	12,5	7,0	
ED-126-EB	12,6	7,0	
ED-127-EB	12,7	7,0	
ED-128-EB	12,8	7,0	
ED-129-EB	12,9	7,0	
ED-130-EB	13,0	7,6	ED130/139-16-..D-..
ED-131-EB	13,1	7,6	
ED-132-EB	13,2	7,6	
ED-133-EB	13,3	7,6	
ED-134-EB	13,4	7,6	
ED-135-EB	13,5	7,6	
ED-136-EB	13,6	7,6	
ED-137-EB	13,7	7,6	
ED-138-EB	13,8	7,6	
ED-139-EB	13,9	7,6	

## RAPID DRILL / RAPID DRILL

### ED...EB DÜZ ÖZEL KESİCİ UÇ / ED...EB SPECIAL CUTTING INSERT

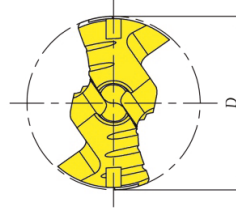
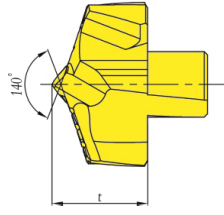
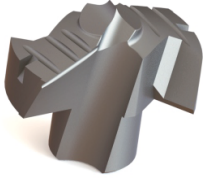

Uç Kodu Insert Code	Boyutlar Dimensions(mm)		Tutucu Kodu Holder Code
	D	t	
ED-140-EB	14	8,1	ED140/149-16-..D-..
ED-141-EB	14,1	8,1	
ED-142-EB	14,2	8,1	
ED-143-EB	14,3	8,1	
ED-144-EB	14,4	8,1	
ED-145-EB	14,5	8,1	
ED-146-EB	14,6	8,1	
ED-147-EB	14,7	8,1	
ED-148-EB	14,8	8,1	
ED-149-EB	14,9	8,1	
ED-150-EB	15,0	8,7	EDM150/159-20-..D-..
ED-151-EB	15,1	8,7	
ED-152-EB	15,2	8,7	
ED-153-EB	15,3	8,7	
ED-154-EB	15,4	8,7	
ED-155-EB	15,5	8,7	
ED-156-EB	15,6	8,7	
ED-157-EB	15,7	8,7	
ED-158-EB	15,8	8,7	
ED-159-EB	15,9	8,7	
ED-160-EB	16,0	9,3	ED160/169-20-..D-..
ED-161-EB	16,1	9,3	
ED-162-EB	16,2	9,3	
ED-163-EB	16,3	9,3	
ED-164-EB	16,4	9,3	
ED-165-EB	16,5	9,3	
ED-166-EB	16,6	9,3	
ED-167-EB	16,7	9,3	
ED-168-EB	16,8	9,3	
ED-169-EB	16,9	9,3	

Uç Kodu Insert Code	Boyutlar Dimensions(mm)		Tutucu Kodu Holder Code
	D	t	
ED-170-EB	17,0	9,9	ED170/179-20-..D-..
ED-171-EB	17,1	9,9	
ED-172-EB	17,2	9,9	
ED-173-EB	17,3	9,9	
ED-174-EB	17,4	9,9	
ED-175-EB	17,5	9,9	
ED-176-EB	17,6	9,9	
ED-177-EB	17,7	9,9	
ED-178-EB	17,8	9,9	
ED-179-EB	17,9	9,9	
ED-180-EB	18,0	10,5	ED180/189-25-..D-..
ED-181-EB	18,1	10,5	
ED-182-EB	18,2	10,5	
ED-183-EB	18,3	10,5	
ED-184-EB	18,4	10,5	
ED-185-EB	18,5	10,5	
ED-186-EB	18,6	10,5	
ED-187-EB	18,7	10,5	
ED-188-EB	18,8	10,5	
ED-189-EB	18,9	10,5	
ED-190-EB	19,0	11,0	ED190/199-25-..D-..
ED-191-EB	19,1	11,0	
ED-192-EB	19,2	11,0	
ED-193-EB	19,3	11,0	
ED-194-EB	19,4	11,0	
ED-195-EB	19,5	11,0	
ED-196-EB	19,6	11,0	
ED-197-EB	19,7	11,0	
ED-198-EB	19,8	11,0	
ED-199-EB	19,9	11,0	

EB uçlar çok iyi merkezleme özelliğine sahiptir ve düşük kesme kuvvetiyle delik delme operasyonlarını tamamlayabilir. Paslanmaz çelik, titanyum, nikel bazlı alaşımlar, mangan çeliği gibi işleme zor malzemeler için tavsiye edilir. *EB type insert ensures excellent hole positioning through its self-centering point and can drill with low cutting force. EA insert can be used for machining stainless steel, titanium, nickel based alloys, Mn steel.*

## RAPID DRILL / RAPID DRILL

## ED...EB DÜZ ÖZEL KESİCİ UÇ / ED...EB SPECIAL CUTTING INSERT

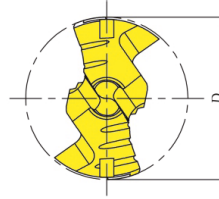
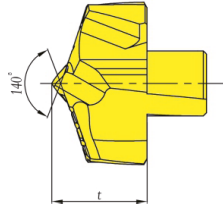
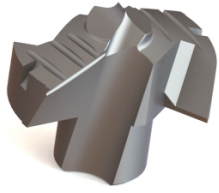

Uç Kodu Insert Code	Boyutlar Dimensions(mm)		Tutucu Kodu Holder Code
	D	t	
ED-200-EB	20	11,6	ED200/209-25-..D-..
ED-201-EB	20,1	11,6	
ED-202-EB	20,2	11,6	
ED-203-EB	20,3	11,6	
ED-204-EB	20,4	11,6	
ED-205-EB	20,5	11,6	
ED-206-EB	20,6	11,6	
ED-207-EB	20,7	11,6	
ED-208-EB	20,8	11,6	
ED-209-EB	20,9	11,6	
ED-210-EB	21	12,1	ED210/219-25-..D-..
ED-211-EB	21,1	12,1	
ED-212-EB	21,2	12,1	
ED-213-EB	21,3	12,1	
ED-214-EB	21,4	12,1	
ED-215-EB	21,5	12,1	
ED-216-EB	21,6	12,1	
ED-217-EB	21,7	12,1	
ED-218-EB	21,8	12,1	
ED-219-EB	21,9	12,1	
ED-220-EB	22	12,7	ED220/229-25- D-
ED-221-EB	22,1	12,7	
ED-222-EB	22,2	12,7	
ED-223-EB	22,3	12,7	
ED-224-EB	22,4	12,7	
ED-225-EB	22,5	12,7	
ED-226-EB	22,6	12,7	
ED-227-EB	22,7	12,7	
ED-228-EB	22,8	12,7	
ED-229-EB	22,9	12,7	

Uç Kodu Insert Code	Boyutlar Dimensions(mm)		Tutucu Kodu Holder Code
	D	t	
ED-230-EB	23,0	13,3	ED230/239-32-..D-..
ED-231-EB	23,1	13,3	
ED-232-EB	23,2	13,3	
ED-233-EB	23,3	13,3	
ED-234-EB	23,4	13,3	
ED-235-EB	23,5	13,3	
ED-236-EB	23,6	13,3	
ED-237-EB	23,7	13,3	
ED-238-EB	23,8	13,3	
ED-239-EB	23,9	13,3	
ED-240-EB	24,0	13,9	ED240/249-32-..D-..
ED-241-EB	24,1	13,9	
ED-242-EB	24,2	13,9	
ED-243-EB	24,3	13,9	
ED-244-EB	24,4	13,9	
ED-245-EB	24,5	13,9	
ED-246-EB	24,6	13,9	
ED-247-EB	24,7	13,9	
ED-248-EB	24,8	13,9	
ED-249-EB	24,9	13,9	
ED-250-EB	25,0	14,5	ED250/260-32- D-
ED-251-EB	25,1	14,5	
ED-252-EB	25,2	14,5	
ED-253-EB	25,3	14,5	
ED-254-EB	25,4	14,5	
ED-255-EB	25,5	14,5	
ED-256-EB	25,6	14,5	
ED-257-EB	25,7	14,5	
ED-258-EB	25,8	14,5	
ED-259-EB	25,9	14,5	
ED-260-EB	26,0	14,5	

EB uçlar çok iyi merkezleme özelliğine sahiptir ve düşük kesme kuvvetiyle delik delme operasyonlarını tamamlayabilir. Paslanmaz çelik, titanyum, nikel bazlı alaşımlar, mangan çeliği gibi işlenmesi zor malzemeler için tavsiye edilir. *EB type insert ensures excellent hole positioning through its self-centering point and can drill with low cutting force. EA insert can be used for machining stainless steel, titanium, nickel based alloys, Mn steel.*

## RAPID DRILL / RAPID DRILL

### ED...1,5D-CA MATKAPLAR / ED...1,5D-CA TOOLHOLDERS

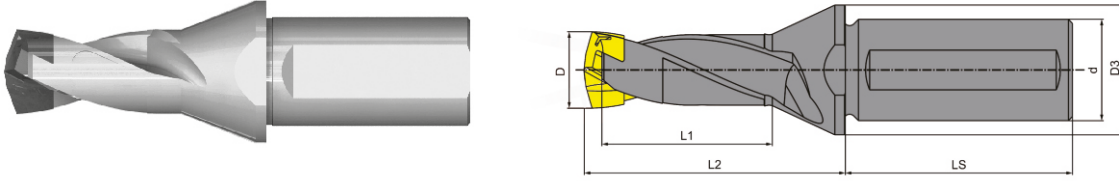

Ürün Kodu Order No	Uygulanabilir Kesim Kafa Çapı Applicable Cutting Head Dia	Boyutlar Dimensions(mm)					Anahtar Wrench
		d	D3	L1	Ls	D	
ED080/089-12-1,5D-CA	8,0-8,9	12	16	16	45	7,8	8-11,9
ED090/099-12-1,5D-CA	9,0-9,9	12	16	18	45	8,8	
ED100/109-16-1,5D-CA	10,0-10,9	16	20	20	48	9,8	
ED110/119-16-1,5D-CA	11,0-11,9	16	20	22	48	10,8	
ED120/129-16-1,5D-CA	12,0-12,9	16	20	24	48	11,8	12-16,9
ED130/139-16-1,5D-CA	13,0-13,9	16	20	25	48	12,8	
ED140/149-16-1,5D-CA	14,0-14,9	16	20	27	48	118,0	
ED150/159-20-1,5D-CA	15,0-15,9	20	25	29	50	14,8	
ED160/169-20-1,5D-CA	16,0-16,9	20	25	30	50	15,8	17-20,9
ED170/179-20-1,5D-CA	17,0-17,9	20	25	32	50	16,8	
ED180/189-23-1,5D-CA	18,0-18,9	25	32	34	56	17,8	
ED190/199-25-1,5D-CA	19,0-19,9	25	32	36	56	18,8	
ED200/209-25-1,5D-CA	20,0-20,9	25	32	38	56	19,8	21-26
ED210/219-23-1,5D-CA	21,0-21,9	25	32	40	56	20,8	
ED220/229-2S-1,5D-CA	22,0-22,9	25	32	42	56	21,8	
ED230/239-32-1,5D-CA	23,0-23,9	32	42	43	60	22,8	
ED240/249-32-1,5D-CA	24,0-24,9	32	42	45	60	23,8	
ED250/260-32-1,5D-CA	25,0-26,0	32	42	47	60	24,8	

## RAPID DRILL / RAPID DRILL

## ED...1,5D-CA MATKAPLAR / ED...1,5D-CA TOOLHOLDERS

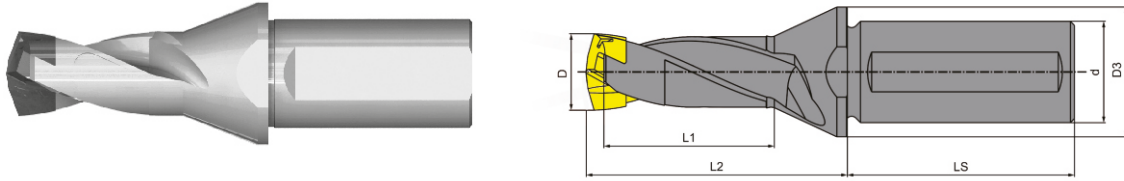

Ürün Kodu Order No	Uygulanabilir Kesim Kafa Çapı Applicable Cutting Head Dia	Boyutlar Dimensions(mm)					Anahtar Wrench
		d	D3	L1	Ls	D	
İnç/Inch	İnç/Inch	İnç/Inch	mm	mm	mm	mm	
ED/16-11/32-1/2-1,5D-CA	5/16-11/32	1/2	16	16	45	7,5	8-11,9
ED23/64-25/64-1/2-1,5D-CA	23/64-25/64	1/2	16	18	4S	8,8	
ED13/32-27/64-5/8-1,5D-CA	13/32-27/64	5/8	20	20	48	9,9	
ED7/16-15/32-5/8-1,5D-CA	7/16-15/32	5/8	20	22	48	10,7	
ED31/64-1/2-5/8-1,5D-CA	31/64-1/2	5/8	20	24	48	11,9	12-16,9
ED33/64-35/64-1/2-1,5D-CA	33/64-35/64	5/8	20	25	48	12,6	
ED9/16-37/64-1/2-1,5D-CA	9/16-37/64	5/8	25	27	48	13,8	
ED19/32-5/8-3/4-1,5D-CA	19/32-5/8	3/4	25	29	30	14,5	
ED41/64-21/32-3/4-1,5D-CA	41/64-21/32	3/4	25	30	50	15,6	17-20,9
ED43/64-45/64-3/4-1,5D-CA	43/64-45/64	3/4	2S	32	50	16,7	
ED23-32/47/64-1-11,5D-CA	23/32-47/64	1	32	34	36	17,6	
ED3/8-25/32-1-1,5D-CA	3/8-25/32	1	32	36	36	18,4	
ED51/64-13/16-1-1,5D-CA	51/64-13/16	1	32	38	56	19,6	21-26
ED53/64-55/64-1-1,5D-CA	53/64-55/64	1	32	40	56	20,4	
ED7/8-57/64-1-1,5D-CA	7/8-57/64	1	32	42	56	21,6	
ED29/32-59/64-1 1/4-1,5D-CA	29/32-59/64	1 1/4	42	43	60	22,4	
ED/61/64-31/32-1 1/4-1,5D-CA	61/64-1/32	1 1/4	42	45	60	23,6	21-26
ED63/64-1-1 1/4-1,5D-CA	63/64-1	1 1/4	42	47	60	24,4	

## RAPID DRILL / RAPID DRILL

### ED...1,5D-CA MATKAPLAR / ED...1,5D-CA TOOLHOLDERS

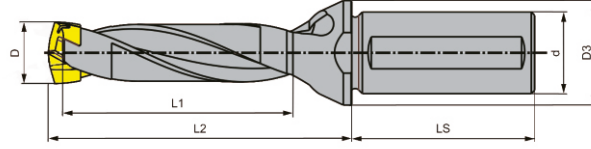

Ürün Kodu Order No	Uygulanabilir Kesim Kafa Çapı Applicable Cutting Head Dia	Boyutlar Dimensions(mm)					Anahtar Wrench
		d	D3	L1	Ls	D	
ED080/089-12-3D-CA	8,0-8,9	12	16	1	45	7,8	8-11,9
ED090/099-12-3D-CA	9,0-9,9	12	16	35	45	8,8	
ED100/109-16-3D-CA	10,0-10,9	16	20	39	48	9,8	
ED110/119-16-3D-CA	11,0-11,9	16	20	42	48	10,8	
ED120/129-16-3D-CA	12,0-12,9	16	20	45	48	11,8	12-16,9
ED130/139-16-3D-CA	13,0-13,9	16	20	49	48	12,8	
ED140/149-16-3D-CA	14,0-14,9	16	20	53	48	13,8	
ED150/159-20-3D-CA	15,0-15,9	20	25	56	fi0	14,8	
ED160/169-20-3D-CA	16,0-16,9	20	25	60	50	15,8	17-20,9
ED170/179-20-3D-CA	17,0-17,9	20	25	63	50	16,8	
ED180/189-25-3D-CA	18,0-18,9	25	25	66	56	17,8	
ED190/199-25-3D-CA	19,0-19,9	25	32	70	56	18,8	
ED200/209-25-3D-CA	20,0-20,9	25	32	73	56	19,8	21-26
ED210/219-25-3D-CA	21,0-21,9	23	32	77	56	20,8	
ED220/229-25-3D-CA	22,0-22,9	25	32	80	56	21,8	
ED230/239-32-3D-CA	23,0-23,9	32	42	84	60	22,8	
ED240/249-32-3D-CA	24,0-24,9	32	42	88	60	23,8	21-26
ED250/260-32-3D-CA	25,0-26,0	32	42	91	60	24,8	

## RAPID DRILL / RAPID DRILL

## ED...1,5D-CA MATKAPLAR / ED...1,5D-CA TOOLHOLDERS

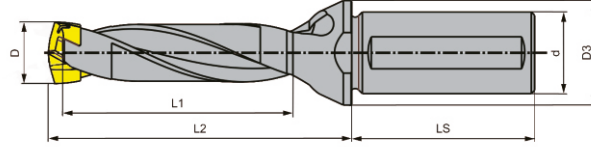

Ürün Kodu Order No	Uygulanabilir Kesim Kafa Çapı Applicable Cutting Head Dia	Boyutlar Dimensions(mm)					Anahtar Wrench
		d	D3	L1	Ls	D	
İnç/Inch	İnç/Inch	İnç/Inch	mm	mm	mm	mm	
ED5/16-11/32-1/2-3D-CA	5/16-11/32	1/2	16	32	45	7,5	8-11,9
ED23/64-25/64-1/2-3D-CA	23/64-25/64	1/2	16	32	45	8,8	
ED13/32-27/64-5/8-3D-CA	13/32-7/64	3/8	20	39	48	9,9	
ED7/16-15/32-5/8-3D-CA	7/16-15/32	5/8	20	42	48	10,7	
ED31/64-1/2-3/8-3D-CA	31/64-1/2	3/8	20	42	48	11,9	12-16,9
ED33/64-35/64-1/2-3D-CA	33/64-35/64	5/8	20	42	48	12,6	
ED9/16-37/64-1/2-3D-CA	9/16-37/64	3/8	25	53	48	13,8	
ED19/32-3/8-3/4-3D-CA	19/32-5/8	3/4	25	56	50	14,5	
ED41/64-21/32-3/4-3D-CA	41/64-21/32	3/4	23	60	50	15,6	17-20,9
ED43/64-45/64-3/4-3D-CA	43/64-21/32	3/4	25	63	50	16,7	
ED23/32-47/64-1-3D-CA	43/64-45/64	1	32	66	56	17,6	
ED3/8-25/32-1-3D-CA	23/32-47/64	1	32	70	56	18,4	
ED61/64-13/16-1-3D-CA	3/8-25/32	1	32	73	56	19,6	21-26
ED55/64-55/64-1-3D-CA	51/64-13/16	1	32	77	56	20,4	
ED7/8-57/64-1-3D-CA	53/64-55/64	1	32	80	56	21,6	
ED29/32-59/64-1 1/4-3D-CA	7/8-57/64	1 1/4	42	84	60	22,4	
ED61/64-31/32-1 1/4-3D-CA	29/32-59/64	1 1/4	42	88	60	23,6	21-26
ED63/64-1-1 1/4-3D-CA	61/64-1/32	1 1/4	42	91	60	24,4	

## RAPID DRILL / RAPID DRILL

### ED...1,5D-CA MATKAPLAR / ED...1,5D-CA TOOLHOLDERS

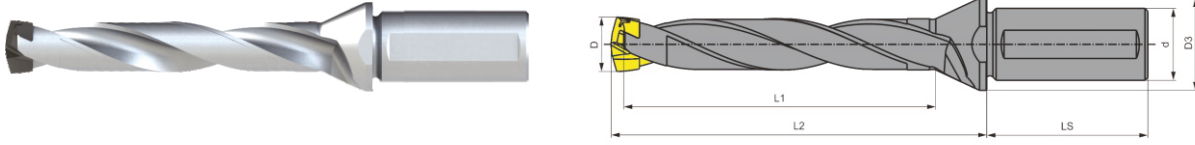

Ürün Kodu Order No	Uygulanabilir Kesim Kafa Çapı Applicable Cutting Head Dia	Boyutlar Dimensions(mm)					Anahtar Wrench
		d	D3	L1	Ls	D	
ED080/089-12-5D-CA	8,0-8,9	12	16	50	45	7,8	8-11,9
ED090/099-12-5D-CA	9,0-9,9	12	16	55	45	8,8	
ED100/109-16-5D-CA	10,0-10,9	16	20	60	48	9,8	
ED110/119-16-5D-CA	11,0-11,9	16	20	66	48	10,8	
ED120/129-16-5D-CA	12,0-12,9	16	20	71	48	11,8	12-16,9
ED130/139-16-5D-CA	13,0-13,9	16	20	77	48	12,8	
ED140/149-16-5D-CA	14,0-14,9	16	20	82	48	118,0	
ED150/159-20-5D-CA	15,0-15,9	20	23	88	50	14,8	
ED160/169-20-5D-CA	16,0-16,9	20	25	93	50	15,8	17-20,9
ED170/179-20-5D-CA	17,0-17,9	20	2fi	99	50	16,8	
ED180/189-25-5D-CA	18,0-18,9	25	32	104	56	17,8	
ED190/199-25-5D-CA	19,0-19,9	25	32	110	56	18,8	
ED200/209-25-5D-CA	20,0-20,9	25	32	115	56	19,8	21-26
ED210/219-25-5D-CA	21,0-21,9	25	32	121	56	20,8	
ED220/229-25-5D-CA	22,0-22,9	25	32	126	56	21,8	
ED230/239-32-5D-CA	23,0-23,9	32	42	132	60	22,8	
ED240/249-32-5D-CA	24,0-24,9	32	42	137	60	218,0	
ED250/260-32-5D-CA	25,0-26,0	32	42	143	60	24,8	

## RAPID DRILL / RAPID DRILL

## ED...1,5D-CA MATKAPLAR / ED...1,5D-CA TOOLHOLDERS

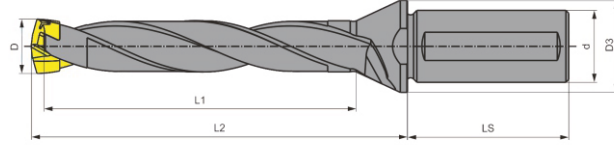

Ürün Kodu Order No	Uygulanabilir Kesim Kafa Çapı Applicable Cutting Head Dia	Boyutlar Dimensions(mm)					Anahtar Wrench
		d	D3	L1	Ls	D	
İnç/Inch	İnç/Inch	İnç/Inch	mm	mm	mm	mm	
ED6/1611/321/2-5D-CA	5/16-11/32	1/2	16	50	45	7,5	8,11,2009
ED25/64-25/64M/2-5D-CA	23/64-25/64	1/2	16	55	45	8,8	
ED13/32-27/64-5/8-5D-CA	13/32-27/64	5/8	20	60	48	9,9	
ED7/1615/325/8-5D-CA	7/16-15/32	5/8	20	66	48	10,7	
ED3/641/21/8-5D-CA	31/64-1/2	5/8	20	71	48	11,9	12-16,9
ED33/64-35/64-1/2-5D-CA	33/64-35/64	5/8	20	77	48	12,6	
ED9/16-37/64-1/2-5D-CA	9/16-37/64	5/8	25	82	48	13,8	
ED19/32-5/8-3/4-5D-CA	19/32-5/8	3/4	25	88	fi0	14,5	
ED41/64-21/32-3/4-5D-CA	41/64-21/32	3/4	25	93	50	15,6	17-20,9
ED43/64-43/64-3/4-SD-CA	43/64-45/64	3/4	25	99	50	16,7	
ED23/32-47/64-1-5D-CA	23/32-47/64	1	32	104	56	17,6	
ED3/8-25/32-1-5D-CA	3/8-25/32	1	32	110	56	18,4	
ED31/64-13/16-1-5D-CA	51/64-13/16	1	32	115	56	19,6	21-26
EDS3/64-35/64-1-5D-CA	53/64-55/64	1	32	121	56	20,4	
ED7/8-57/64-1-5D-CA	7/8-57/64	1	32	126	fi6	21,6	
ED29/32-59/64-1 1/4-5D-CA	29/32-59/64	1 1/4	42	132	60	22,4	
ED61/64-31/32-1 1/4-5D-CA	61/64-1/32	1 1/4	42	137	60	23,6	21-26
ED63/641-11/4-5D-CA	63/64-1	1 1/4	42	143	60	24,4	

## RAPID DRILL / RAPID DRILL

### ED...8D-CA MATKAPLAR / ED...8D-CA TOOLHOLDERS

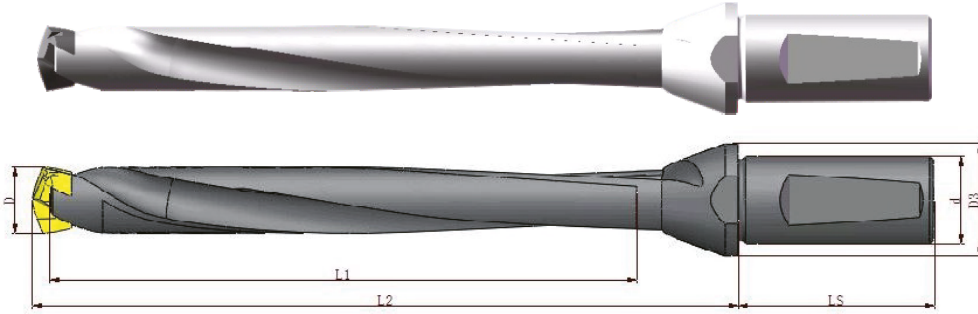

Ürün Kodu Order No	Uygulanabilir Kesim Kafa Çapı Applicable Cutting Head Dia	Boyutlar Dimensions(mm)					Anahtar Wrench
		d	D3	L1	Ls	D	
ED080/089-12-8D-CA	8,0-8,9	12	16	76	45	7,6	8-11,9
ED090/099-12-8D-CA	9,0-9,9	12	16	85	45	8,6	
ED100/109-16-8D-CA	10,0-10,9	16	20	93	48	9,6	
ED110/119-16-8D-CA	11,0-11,9	16	20	102	48	10,6	
ED120/129-16-8D-CA	12,0-12,9	16	20	110	48	11,6	12-16,9
ED130/139-16-8D-CA	13,0-13,9	16	20	119	48	12,6	
ED140/149-16-8D-CA	14,0-14,9	16	20	127	48	13,6	
ED150/159-20-8D-CA	15,0-15,9	20	25	136	50	14,6	
ED160/169-20-8D-CA	16,0-16,9	20	25	144	50	15,6	7-20,9
ED170/179-20-8D-CA	17,0-17,9	20	25	153	50	16,6	
ED180/189-25-8D-CA	18,0-18,9	25	32	161	56	17,6	
ED190/199-25-8D-CA	19,0-19,9	25	32	170	56	18,6	
ED200/209-25-8D-CA	20,0-20,9	25	32	178	56	19,6	21-26
ED210/219-25-8D-CA	21,0-21,9	25	32	187	56	20,6	
ED220/229-25-8D-CA	22,0-22,9	25	32	195	56	21,6	
ED230/239-32-8D-CA	23,0-23,9	32	42	204	60	22,6	
ED240/249-32-8D-CA	24,0-24,9	32	42	212	60	23,6	
ED250/260-32-8D-CA	25,0-26,0	32	42	221	60	24,6	

## RAPID DRILL / RAPID DRILL

## ED...8D-CA MATKAPLAR / ED...8D-CA TOOLHOLDERS

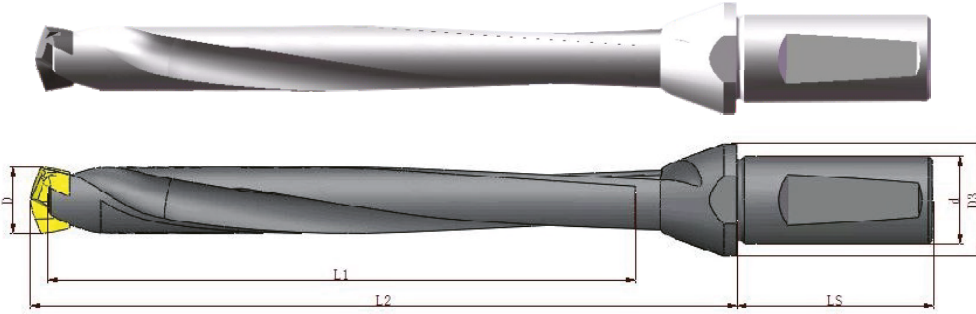

Ürün Kodu Order No	Uygulanabilir Kesim Kafa Çapı Applicable Cutting Head Dia	Boyutlar Dimensions(mm)					Anahtar Wrench
		d	D3	L1	Ls	D	
İnç/Inch	İnç/Inch	İnç/Inch	mm	mm	mm	mm	
ED6/1611/321/2-8D-CA	5/16-11/32	1/2	16	76	45	7,5	8-11,9
ED25/64-25/64M/2-8D-CA	23/64-25/64	1/2	16	85	45	8,8	
ED13/32-27/64-5/8-8D-CA	13/32-27/64	5/8	20	93	48	9,9	
ED7/1615/325/8-8D-CA	7/16-15/32	3/8	20	102	48	10,7	
ED3/641/21/8-8D-CA	31/64-1/2	5/8	20	110	48	11,9	12-16,9
ED33/64-35/64-1/2-8D-CA	33/64-35/64	5/8	20	119	48	12,6	
ED9/16-37/64-1/2-8D-CA	9/16-37/64	5/8	23	127	48	13,8	
ED19/32-5/8-3/4-8D-CA	19/32-5/8	3/4	25	136	50	14,5	
ED41/64-21/32-3/4-8D-CA	41/64-21/32	3/4	25	144	50	15,6	17-20,9
ED43/64-43/64-3/4-8D-CA	43/64-45/64	3/4	25	153	50	16,7	
ED23/32-47/64-1-8D-CA	23/32-47/64	1	32	161	56	17,6	
ED3/8-25/32-1-8D-CA	3/8-25/32	1	32	170	56	18,4	
ED31/64-13/16-1-8D-CA	51/64-13/16	1	32	178	56	19,6	21-26
EDS3/64-35/64-1-8D-CA	53/64-55/64	1	32	187	56	20,4	
ED7/8-57/64-1-8D-CA	7/8-57/64	1	32	195	56	21,6	
ED29/32-59/64-1 1/4-8D-CA	29/32-59/64	1 1/4	42	204	60	22,4	
ED61/64-31/32-1 1/4-8D-CA	61/64-1/32	1 1/4	42	212	60	23,6	21-26
ED63/641-11/4-8D-CA	63/64-1	1 1/4	42	221	60	24,4	

## RAPID DRILL / RAPID DRILL

### ED...12D-CA MATKAPLAR / ED...12D-CA TOOLHOLDERS

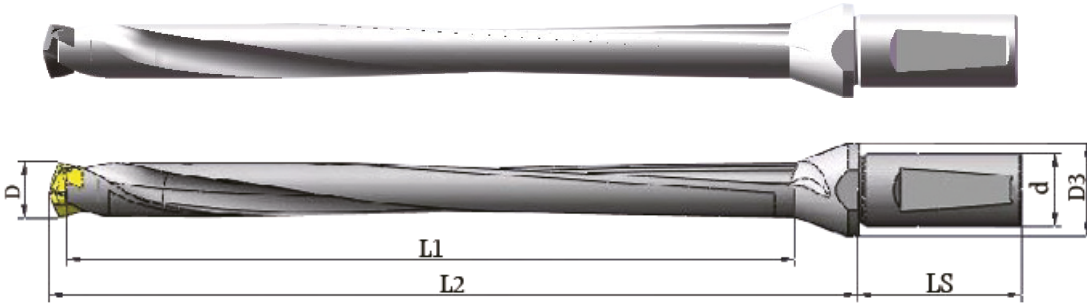

Ürün Kodu Order No	Uygulanabilir Kesim Kafa Çapı Applicable Cutting Head Dia	Boyutlar Dimensions(mm)					Anahtar Wrench
		d	D3	L1	Ls	D	
ED120/129-16-12D-CA	12,0-12,9	16	20	162	48	11,6	12-16,9
ED130/139-16-12D-CA	11,0-13,9	16	20	175	48	12,6	
ED140/149-16-12D-CA	14,0-14,9	16	20	187	48	13,6	
ED160/159-20-12D-CA	15,0-15,9	20	20	200	50	14,6	
ED160/169-20-12D-CA	16,0-16,9	20	20	212	50	15,6	
ED170/179-20-12D-CA	17,0-17,9	20	20	225	50	16,6	
ED180/189-23-12D-CA	18,0-18,9	25	32	237	56	17,6	
ED190/199-25-12D-CA	19,0-19,9	25	32	250	56	18,6	
ED200/209-25-12D-CA	20,0-20,9	25	32	262	56	19,6	
ED210/219-25-12D-CA	21,0-21,9	25	32	275	56	20,6	
ED220/229-25-12D-CA	22,0-22,9	25	32	287	56	21,6	21-26
ED230/239-32-12D-CA	23,0-23,9	32	42	300	60	22,6	
ED240/249-32-12D-CA	24,0-24,9	32	42	313	60	23,6	
ED260/260-32-12D-CA	25,0-26,0	32	42	325	60	24,6	
İnç/Inch	İnç/Inch	İnç/Inch	mm	mm	mm	mm	
ED31/64-1/2-5/8-12D-CA	31/64-1/2	5/8	20	162	48	11,9	
ED33/64-35/64-1/2-12D-CA	33/64-35/64	5/8	20	175	48	12,6	
ED9/16-37/64-1/2-12D-CA	9/16-37/64	5/8	25	187	48	13,8	
ED19/32-5/8-3/4-12D-CA	19/32-5/8	3/4	25	200	50	14,5	
ED41/64-21/32-3/4-12D-CA	41/64-21/32	3/4	25	212	50	15,6	
ED43/64-45/64-3/4-12D-CA	43/64-45/64	3/4	25	225	50	16,7	17-20,9
ED23/32-47/64-1-12D-CA	23/32-47/64	1	32	237	56	17,6	
ED51/64-13/16-1-12D-CA	51/64-13/16	1	32	262	56	19,6	
EDS3/64-55/64-1-12D-CA	53/64-55/64	1	32	275	56	20,4	
EDS7/64-57/64-1-12D-CA	7/8-57/64	1	32	287	56	21,6	
ED29/32-59/64-11/4-12D-CA	29/32-59/64	11/4	42	300	60	22,4	
ED61/64-31/32-11/4-12D-CA	61/64-1/32	11/4	42	313	60	23,6	

## DELME TAKIMI KODLAMA SİSTEMİ

### DRILLING TOOL CODING SYSTEM

**ED**
**120**
**129**
**16**
**3D**
**CA**

1

2

3

4

5

6

1 ED 120 129 16 3D CA ED: E-Drill	2 ED 120 129 16 3D CA Uygulanabilir min kesme kafası çapı(mm) Applicable min cutting head dia.(mm) 12,0 mm	3 ED 120 129 16 3D CA Uygulanabilir max kesme kafası çapı(mm) Applicable max cutting head dia.(mm) 12,9 mm
4 ED 120 129 16 3D CA Şaft Çapı(mm) Shank Dia. 16,0 mm	5 ED 120 129 16 3D CA Matkap Derinliği 1,5xD Drill Depth 1,5xD Matkap Derinliği 3xD Drill Depth 3xD Matkap Derinliği 5xD Drill Depth 5xD Matkap Derinliği 8xD Drill Depth 8xD Matkap Derinliği 12xD Drill Depth 12xD	6 ED 120 129 16 3D CA CA: Soğutucu ile CA: With coolant

## ÇOK UÇLU LINE YEKPARE TAKIM TUTUCU KOD SİSTEMİ

### MULTI DRILL SOLID TOOLHOLDER CODE SYSTEM

**ED**
**3300**
**32**
**8D**
**D16**
**W08**

1

2

3

4

5

6

1 ED 3300 32 8D D16 W08 ED: E-DRILL	2 ED 3300 32 8D D16 W08 Kesme Başlığı Çapı Cutting Drill Dia. 28-42 mm	3 ED 3300 32 8D D16 W08 Şaft Çapı Shank Dia. 32,0 mm
4 ED 3300 32 8D D16 W08 Delme Derinliği 3xD Drill Depth 3xD Delme Derinliği 5xD Drill Depth 5xD Delme Derinliği 6xD Drill Depth 6xD Delme Derinliği 7xD Drill Depth 7xD Delme Derinliği 8xD Drill Depth 8xD Delme Derinliği 10xD Drill Depth 10xD	5 ED 3300 32 8D D16 W08 Merkez Matkap Kafası Çapı 16 mm Center Drill Head Dia. 16 mm	6 ED 3300 32 8D D16 W08 Kesici Uç Geniřliđi 8 mm Side Insert Length 8 mm

## RAPID DRILL / RAPID DRILL

### ED...3D YEKPARE TAKIM TUTUCULAR / ED...3D SOLID TOOLHOLDERS

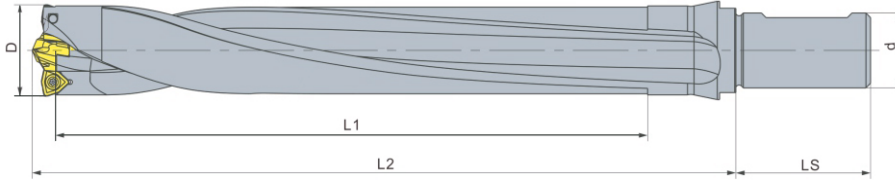

Ürün Kodu Order No	Merkez Matkap Başlığı Çapı Center Drill Head Dia	Yan Uç Side Inserts	Boyutlar Dimensions(mm)					Yedek Parça Spare Parts		
			d	L1	L2	Ls	D	Anahtar Key	Vida Screw	Anahtar Wrench
ED2800-32-3D-D14/A04	MD-140-EA	AOMT040308	32	84	118	60,0	28	14-16	M2.5X8	T9
ED2858-32-3D-D15/A04	MD-150-EA	AOMT040308	32	86	120	60,0	28,58			
ED2900-32-3D-D16/A04	MD-160-EA	AOMT040308	32	87	121	60,0	29			
ED2936-32-3D-D16/A04	MD-160-EA	AOMT040108	32	89	123	60,0	29,36			
ED3000-32-3D-D16/A04	MD-160-EA	AOMT040308	32	90	125	60,0	30			
ED3018-32-3D-D17/A04	MD-170-EA	AOMT040308	32	91	126	60,0	30,18	17-20		
ED3096-32-3D-D17/A04	MD-170-EA	AOMT040308	32	93	128	60,0	30,96			
ED3100-32-3D-D17/A04	MD-170-EA	AOMT040308	32	94	129	60,0	31			
ED3175-32-3D-D15/W08	MD-150-EA	WOMT080308-...-D33	32	96	133	60,0	31,75	14-16	M3X8	T10
ED3200-32-3D-D15/W08	MD-170-EA	WOMT080308-...-D33	32	97	134	60,0	32			
ED3300-32-3D-D16/W08	MD-160-EA	WOMT080308-...-D33	32	99	136	60,0	33			
ED3320-32-3D-D16/W08	MD-160-EA	WOMT080308-...-D33	32	100	137	60,0	33,2			
ED3335-32-3D-D16/W08	MD-160-EA	WOMT080308-...-D33	32	101	138	60,0	33,35			
ED3400-32-3D-D16/W08	MD-160-EA	WOMT080308-...-D33	32	102	139	60,0	34	17-20		
ED3493-32-3D-D18/W08	MD-180-EA	WOMT080308-...-D33	32	105	142	60,0	34,93			
ED3500-32-3D-D18/W08	MD-180-EA	WOMT080308-...-D33	32	106	144	60,0	35			
ED3600-32-3D-D18/W08	MD-180-EA	WOMT080308-...-D33	32	108	146	60,0	36	17-20		
ED3653-32-3D-D19/W08	MD-190-EA	WOMT080308-...-D33	32	110	148	60,0	36,53			
ED3700-32-3D-D16/W10	MD-160-EA	WOMT100308-...-D39	3	111	149	60,0	37	14-16		
ED3750-32-3D-D16/W10	MD-160-EA	WOMT100308-...-D39	32	113	151	60,0	37,5			
ED3800-32-3D-D16/W10	MD-160-EA	WOMT100308-...-D39	32	114	154	60,0	38			
ED3810-32-3D-D16/W10	MD-160-EA	WOMT100308-...-D39	32	115	155	60,0	38,1			
ED3900-32-3D-D18/W10	MD-180-EA	WOMT100308-...-D39	32	117	157	60,0	39			
ED3920-32-3D-D18/W10	MD-180-EA	WOMT100308-...-D39	32	118	158	60,0	39,2	17-20		
ED3970-32-3D-D18/W10	MD-180-EA	WOMT100308-...-D39	3	120	160	60,0	39,7			
ED4000-32-3D-D18/W10	MD-180-EA	WOMT100308-...-D39	50	121	164	70,0	40			
ED4100-32-3D-D19/ W10	MD-190-EA	WOMT100308-...-D39	50	123	166	70,0	41	17-20		
ED4128-32-3D-D19/W10	MD-190-EA	WOMT100308-...-D39	50	124	167	70,0	41,28			
ED4200-50-3D-D19/W10	MD-190-EA	WOMT120408-...-D42	fi0	126	170	70,0	42			
ED4300-50-3D-D16/W12	MD-160-EA	WOMT120408-...-D42	50	129	173	70,0	43	14-16		

## RAPID DRILL / RAPID DRILL

## ED...3D YEKPARE TAKIM TUTUCULAR / ED...3D SOLID TOOLHOLDERS

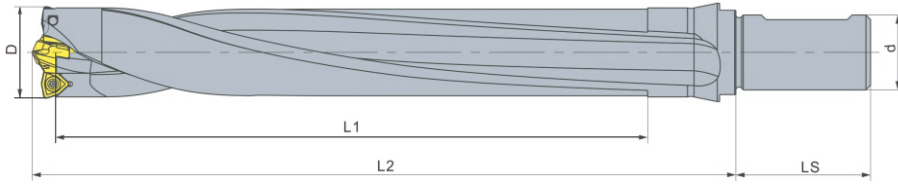

Ürün Kodu Order No	Merkez Matkap Başlığı Çapı Center Drill Head Dia	Yan Uç Side Inserts	Boyutlar Dimensions(mm)					Yedek Parça Spare Parts		
			d	L1	L2	Ls	D	Anahtar Key	Vida Screw	Anahtar Wrench
ED4400-50-3D-D18/W12	MD-180-EA	WOMT120408-...-D42	50	132	176	70,0	44	17-20	M4X10	TU
ED4445-50-3D-D18/W12	MD-180-EA	WOMT120408-...-D42	50	134	178	70,0	44,45			
ED4500-30-3D-D18/W12	MD-180-EA	WOMT120408-...-D42	50	135	179	70,0	45			
ED4600-50-3D-D19/W12	MD-190-EA	WOMT120408-...-D42	30	138	182	70,0	46			
ED4700-50-3D-D20/W12	MD-200-EA	WOMT120408-...-D42	50	141	185	70,0	47			
ED4763-30-3D-D21/W12	MD-210-EA	WOMT120408-...-D42	50	143	187	70,0	47,63			
ED4800-50-3D-D21/W12	MD-210-EA	WOMT120408-...-D42	50	144	189	70,0	48			
ED4900-50-3D-D227W12	MD-220-EA	WOMT120408-...-D42	50	147	192	70,0	49	21-28		
ED5000-50-3D-D23/W12	MD-230-EA	WOMT120408-...-D42	70	150	195	70,0	50			
ED5080-50-3D-D24/W12	MD-240-EA	WOMT120408-...-D42	50	153	198	70,0	50,8			
ED5100-50-3D-D24/W12	MD-240-EA	WOMT120408-...-D42	50	154	199	70,0	51			
ED5200-50-3D-D25/W12	MD-250-EA	WOMT120408-...-D42	50	156	201	70,0	52			
ED3300-30-3D-D26/W12	MD-260-EA	WOMT120408-...-D42	50	159	204	70,0	53			
ED5398-50-3D-D27/W12	MD-270-EA	WOMT120408-...-D42	50	162	207	70,0	53,98			
ED5400-50-3D-D27/W12	MD-270-EA	WOMT120408-...-D42	50	163	208	70,0	54			
ED5500-50-3D-D28/W12	MD-280-EA	WOMT120408-...-D42	50	165	210	70,0	55			

## RAPID DRILL / RAPID DRILL

### ED...5D YEKPARE TAKIM TUTUCULAR / ED...5D SOLID TOOLHOLDERS

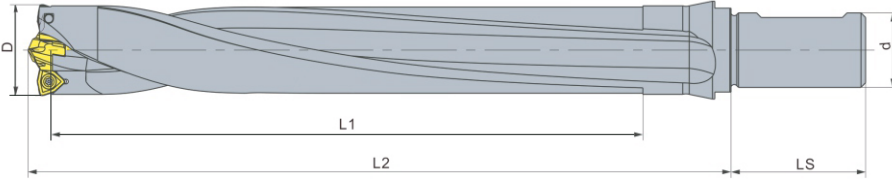

Ürün Kodu Order No	Merkez Matkap Başlığı Çapı Center Drill Head Dia	Yan Uç Side Inserts x2	Boyutlar Dimensions(mm)					Yedek Parça Spare Parts		
			d	L1	L2	Ls	D	Anahtar Key	Vida Screw	Anahtar Wrench
ED2800-32-5D-D14/A04	MD-140-EA	AOMT040308	32	140	174	60,0	28	14-16	M2.5X8	T9
ED2858-32-5D-D15/A04	MD-150-EA	AOMT040308	32	143	177	60,0	28,58			
ED2900-32-5D-D16/A04	MD-160-EA	AOMT040308	32	145	179	60,0	29			
ED2936-32-5D-D16/A04	MD-160-EA	AOMT040108	32	147	181	60,0	29,36			
ED3000-32-5D-D16/A04	MD-160-EA	AOMT040308	32	150	186	60,0	30			
ED3018-32-5D-D17/A04	MD-170-EA	AOMT040308	32	151	186	60,0	30,18			
ED3096-32-5D-D17/A04	MD-170-EA	AOMT040308	32	155	190	60,0	30,96			
ED3100-32-5D-D17/A04	MD-170-EA	AOMT040308	32	156	191	60,0	31	17-20		
ED3175-32-5D-D15/W08	MD-150-EA	WOMT080308-...-D33	32	159	196	60,0	31,75	14-16	M3X8	T10
ED3200-32-3D-D15/W08	MD-150-EA	WOMT080308-...-D33	32	160	197	60,0	32			
ED3300-32-5D-D16/W08	MD-160-EA	WOMT080308-...-D33	32	165	202	60,0	33			
ED3320-32-5D-D16/W08	MD-160-EA	WOMT080308-...-D33	32	166	203	60,0	33,2			
ED3335-32-5D-D16/W08	MD-160-EA	WOMT080308-...-D33	32	167	204	60,0	33,35			
ED3400-32-5D-D16/W08	MD-160-EA	WOMT080308-...-D33	32	170	207	60,0	34			
ED3493-32-5D-D18/W08	MD-180-EA	WOMT080308-...-D33	32	175	212	60,0	34,93			
ED3500-32-5D-D18/W08	MD-180-EA	WOMT080308-...-D33	32	176	214	60,0	35	17-20		
ED3600-32-5D-D18/W08	MD-180-EA	WOMT080308-...-D33	32	180	218	60,0	36			
ED3653-32-5D-D19/W08	MD-190-EA	WOMT080308-...-D33	32	183	221	60,0	36,53			
ED3700-32-5D-D16/W10	MD-160-EA	WOMT100308-...-D39	32	185	223	60,0	37	14-16		
ED3750-32-3D-D16/W10	MD-160-EA	WOMT100308-...-D39	32	188	226	60,0	37,5			
ED3800-32-5D-D16/W10	MD-160-EA	WOMT100308-...-D39	32	190	230	60,0	38			
ED3810-32-5D-D16/W10	MD-160-EA	WOMT100308-...-D39	32	191	231	60,0	38,1			
ED3900-32-5D-D18/W10	MD-180-EA	WOMT100308-...-D39	32	195	235	60,0	39			
ED3920-32-5D-D18/W10	MD-180-EA	WOMT100308-...-D39	32	196	236	60,0	39,2			
ED3970-32-5D-D18/W10	MD-180-EA	WOMT100308-...-D39	32	199	239	60,0	39,7			
ED4000-32-5D-D18/W10	MD-180-EA	WOMT100308-...-D39	50	200	243	70,0	40	17-20		
ED4100-32-5D-D19/W10	MD-190-EA	WOMT100308-...-D39	50	205	248	70,0	41			
ED4128-32-5D-D19/W10	MD-190-EA	WOMT100308-...-D39	50	207	250	70,0	41,28			
ED4200-50-5D-D19/W10	MD-190-EA	WOMT120408-...-D42	50	210	254	70,0	42			
ED4300-50-5D-D16/W12	MD-160-EA	WOMT120408-...-D42	50	213	259	70,0	43	14-16		

## RAPID DRILL / RAPID DRILL

## ED...5D YEKPARE TAKIM TUTUCULAR / ED...5D SOLID TOOLHOLDERS

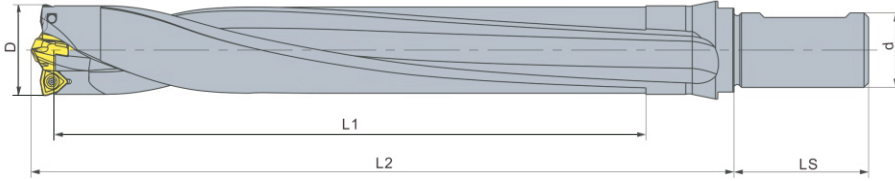

Ürün Kodu Order No	Merkez Matkap Başlığı Çapı Center Drill Head Dia	Yan Uç Side Inserts x2	Boyutlar Dimensions(mm)					Yedek Parça Spare Parts		
			d	L1	L2	Ls	D	Anahtar Key	Vida Screw	Anahtar Wrench
ED4400-50-5D-D18/W12	MD-180-EA	WOMT120408-...-D42	50	220	264	70,0	44	17-20	M4X10	T15
ED4445-50-5D-D18/W12	MD-180-EA	WOMT120408-...-D42	50	223	267	70,0	44,45			
ED4500-30-5D-D18/W12	MD-180-EA	WOMT120408-...-D42	50	225	269	70,0	45			
ED4600-50-5D-D19/W12	MD-190-EA	WOMT120408-...-D42	50	230	274	70,0	46			
ED4700-50-5D-D20/W12	MD-200-EA	WOMT120408-...-D42	50	235	279	70,0	47			
ED4763-30-5D-D21/W12	MD-210-EA	WOMT120408-...-D42	50	239	183	70,0	47,63			
ED4800-50-5D-D21/W12	MD-210-EA	WOMT120408-...-D42	50	240	285	70,0	48	21-28		
ED4900-50-5D-D22/W12	MD-220-EA	WOMT120408-...-D42	50	245	290	70,0	49			
ED5000-50-5D-D23/W12	MD-230-EA	WOMT120408-...-D42	50	250	295	70,0	50			
ED5080-50-3D-D24/W12	MD-240-EA	WOMT120408-...-D42	50	254	299	70,0	50,8			
ED5100-50-5D-D24/W12	MD-240-EA	WOMT120408-...-D42	50	255	300	70,0	51			
ED5200-50-5D-D25/W12	MD-250-EA	WOMT120408-...-D42	50	260	305	70,0	52			
ED3300-30-5D-D26/W12	MD-260-EA	WOMT120408-...-D42	50	265	310	70,0	53			
ED5398-50-5D-D27/W12	MD-270-EA	WOMT120408-...-D42	50	270	315	70,0	53,98			
ED5400-50-5D-D27/W12	MD-270-EA	WOMT120408-...-D42	50	271	316	70,0	54			
ED3500-30-5D-D28/W12	MD-280-EA	WOMT120408-...-D42	50	275	320	70,0	55			

## RAPID DRILL / RAPID DRILL

### ED...6D YEKPARE TAKIM TUTUCULAR / ED...6D SOLID TOOLHOLDERS

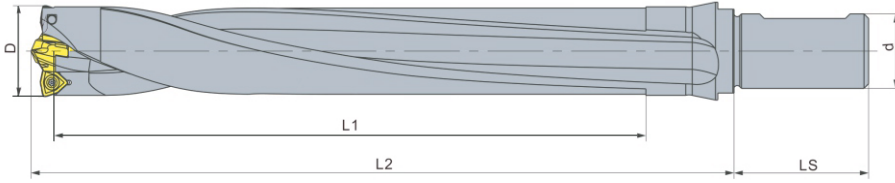

Ürün Kodu Order No	Merkez Matkap Başlığı Çapı Center Drill Head Dia	Yan Uç Side Inserts x2	Boyutlar Dimensions(mm)					Yedek Parça Spare Parts		
			d	L1	L2	Ls	D	Anahtar Key	Vida Screw	Anahtar Wrench
ED2800-32-6D-D14/A04	MD-140-EA	AOMT040308	32	168	202	60,0	28,0	14-16	M2,5X8	T9
ED2858-32-6D-D15/A04	MD-150-EA	AOMT040308	32	172	206	60,0	28,6			
ED2900-32-6D-D16/A04	MD-160-EA	AOMT040308	32	174	208	60,0	29,0			
ED2936-32-6D-D16/A04	MD-160-EA	AOMT040108	32	177	211	60,0	29,4			
ED3000-32-6D-D16/A04	MD-160-EA	AOMT040308	32	180	215	60,0	30,0			
ED3018-32-6D-D17/A04	MD-170-EA	AOMT040308	32	182	217	60,0	30,2			
ED3096-32-6D-D17/A04	MD-170-EA	AOMT040308	32	186	221	60,0	31,0	17-20		
ED3100-32-6D-D17/A04	MD-170-EA	AOMT040308	32	187	222	60,0	31,0			
ED3175-32-6D-D15/W08	MD-150-EA	WOMT080308-...-D33	32	191	228	60,0	31,8	14-16	M3X8	T10
ED3200-32-6D-D15/W08	MD-170-EA	WOMT080308-...-D33	32	192	229	60,0	32,0			
ED3300-32-6D-D16/W08	MD-160-EA	WOMT080308-...-D33	32	198	235	60,0	33,0			
ED3320-32-6D-D16/W08	MD-160-EA	WOMT080308-...-D33	32	200	237	60,0	33,2			
ED3335-32-6D-D16/W08	MD-160-EA	WOMT080308-...-D33	32	201	238	60,0	33,4			
ED3400-32-6D-D16/W08	MD-160-EA	WOMT080308-...-D33	32	204	241	60,0	34,0			
ED3493-32-6D-D18/W08	MD-180-EA	WOMT080308-...-D33	32	210	247	60,0	34,9	17-20		
ED3500-32-6D-D18/W08	MD-180-EA	WOMT080308-...-D33	32	211	249	60,0	35,0			
ED3600-32-6D-D18/W08	MD-180-EA	WOMT080308-...-D33	32	216	254	60,0	36,0			
ED3653-32-6D-D19/W08	MD-190-EA	WOMT080308-...-D33	32	220	258	60,0	36,5	14-16		
ED3700-32-6D-D16/W10	MD-160-EA	WOMT100308-...-D39	32	222	260	60,0	37,0			
ED3750-32-6D-D16/W10	MD-160-EA	WOMT100308-...-D39	32	225	263	60,0	37,5			
ED3800-32-6D-D16/W10	MD-160-EA	WOMT100308-...-D39	32	228	268	60,0	38,0			
ED3810-32-6D-D16/W10	MD-160-EA	WOMT100308-...-D39	32	229	269	60,0	38,1			
ED3900-32-6D-D18/W10	MD-180-EA	WOMT100308-...-D39	32	234	274	60,0	39,0			
ED3920-32-6D-D18/W10	MD-180-EA	WOMT100308-...-D39	32	236	276	60,0	39,2	17-20	M4X10	
ED3970-32-6D-D18/W10	MD-180-EA	WOMT100308-...-D39	32	239	279	70,0	39,7			
ED4000-32-6D-D18/W10	MD-180-EA	WOMT100308-...-D39	50	240	283	70,0	40,0			
ED4100-32-6D-D19/W10	MD-190-EA	WOMT100308-...-D39	50	246	289	70,0	41,0			
ED4128-32-6D-D19/W10	MD-190-EA	WOMT100308-...-D39	50	248	291	70,0	41,3	17-20		
ED4200-50-6D-D19/W10	MD-190-EA	WOMT120408-...-D42	50	252	296	70,0	42,0			

## RAPID DRILL / RAPID DRILL

## ED...6D YEKPARE TAKIM TUTUCULAR / ED...6D SOLID TOOLHOLDERS

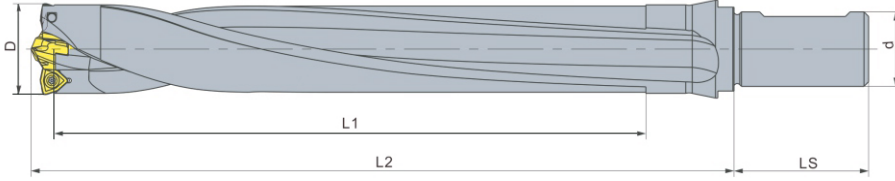

Ürün Kodu Order No	Merkez Matkap Başlığı Çapı Center Drill Head Dia	Yan Uç Side Inserts x2	Boyutlar Dimensions(mm)					Yedek Parça Spare Parts		
			d	L1	L2	Ls	D	Anahtar Key	Vida Screw	Anahtar Wrench
ED4300-S0-6D-D16/W12	MD-160-EA	WOMT120408-...-D42	50	258	302	70,0	43,0	14-16	M4X10	T15
ED4400-50-6D-D18/W12	MD-180-EA	WOMT120408-...-D42	50	264	308	70,0	44,0			
ED4445-50-6D-D18/W12	MD-180-EA	WOMT120408-...-D42	50	267	311	70,0	44,5			
ED4S00-30-6D-D18/W12	MD-180-EA	WOMT120408-...-D42	50	270	314	70,0	45,0			
ED4600-50-6D-D19/W12	MD-190-EA	WOMT120408-...-D42	50	276	320	70,0	46,0			
ED4700-50-6D-D20/W12	MD-200-EA	WOMT120408-...-D42	50	282	326	70,0	47,0			
ED4763-30-6D-D21/W12	MD-210-EA	WOMT120408-...-D42	50	286	330	70,0	47,6	17-20		
ED4800-50-6D-D21/W12	MD-210-EA	WOMT120408-...-D42	50	288	333	70,0	48,0			
ED4900-50-6D-D22/W12	MD-220-EA	WOMT120408-...-D42	50	294	339	70,0	49,0	14-16	M4X10	
ED5000-50-6D-D23/W12	MD-230-EA	WOMT120408-...-D42	50	300	345	70,0	50,0			
EDS080-S0-6D-D24/W12	MD-240-EA	WOMT120408-...-D42	50	305	350	70,0	50,8			
ED5100-50-6D-D24/W12	MD-240-EA	WOMT120408-...-D42	50	306	351	70,0	51,0			
ED5200-50-6D-D25/W12	MD-250-EA	WOMT120408-...-D42	50	312	357	70,0	52,0			
ED3300-30-6D-D26/W12	MD-260-EA	WOMT120408-...-D42	50	318	363	70,0	53,0			
ED5398-50-6D-D27/W12	MD-270-EA	WOMT120408-...-D42	50	324	369	70,0	54,0			
ED5400-50-6D-D27/W12	MD-270-EA	WOMT120408-...-D42	50	325	370	70,0	54,0			
ED3S00-30-6D-D28/W12	MD-280-EA	WOMT120408-...-D42	50	330	375	70,0	55,0			

## RAPID DRILL / RAPID DRILL

### ED...7D YEKPARE TAKIM TUTUCULAR / ED...7D SOLID TOOLHOLDERS

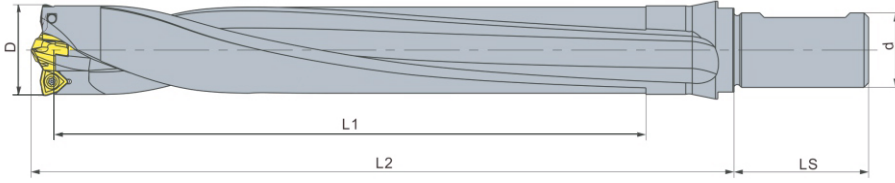

Ürün Kodu Order No	Merkez Matkap Başlığı Çapı Center Drill Head Dia	Yan Uç Side Inserts x2	Boyutlar Dimensions(mm)					Yedek Parça Spare Parts		
			d	L1	L2	Ls	D	Anahtar Key	Vida Screw	Anahtar Wrench
ED2800-32-7D-D14/A04	MD-140-EA	AOMT040308	32	196	230	60,0	28,0	14-16	M2.5X8	T9
ED2858-32-7D-D15/A04	MD-150-EA	AOMT040308	32	201	235	60,0	28,6			
ED2900-32-7D-D16/A04	MD-160-EA	AOMT040308	32	203	237	60,0	29,0			
ED2936-32-7D-D16/A04	MD-160-EA	AOMT040108	32	206	240	60,0	29,4			
ED3000-32-7D-D16/A04	MD-160-EA	AOMT040308	32	210	245	60,0	30,0			
ED3018-32-7D-D17/A04	MD-170-EA	AOMT040308	32	212	247	60,0	30,2	17-20		
ED3096-32-7D-D17/A04	MD-170-EA	AOMT040308	32	217	252	60,0	31,0			
ED3100-32-7D-D17/A04	MD-170-EA	AOMT040308	32	218	253	60,0	31,0			
ED3175-32-7D-D15/W08	MD-150-EA	WOMT080308-...-D33	32	223	260	60,0	35,8	14-16	M3X8	T10
ED3200-32-7D-D15/W08	MD-150-EA	WOMT080308-...-D33	32	224	261	60,0	32,0			
ED3300-32-7D-D16/W08	MD-160-EA	WOMT080308-...-D33	32	231	268	60,0	33,0			
ED3320-32-7D-D16/W08	MD-160-EA	WOMT080308-...-D33	32	233	270	60,0	33,2			
ED3335-32-7D-D16/W08	MD-160-EA	WOMT080308-...-D33	32	234	271	60,0	33,4			
ED3400-32-7D-D16/W08	MD-160-EA	WOMT080308-...-D33	32	238	275	60,0	34,0			
ED3493-32-7D-D18/W08	MD-180-EA	WOMT080308-...-D33	32	245	282	60,0	34,9	17-20		
ED3500-32-7D-D18/W08	MD-180-EA	WOMT080308-...-D33	32	246	284	60,0	35,0			
ED3600-32-7D-D18/W08	MD-180-EA	WOMT080308-...-D33	32	252	290	60,0	36,0			
ED3653-32-7D-D19/W08	MD-190-EA	WOMT080308-...-D33	32	256	294	60,0	36,5	14-16		
ED3700-32-7D-D16/W10	MD-160-EA	WOMT100308-...-D39	32	259	297	60,0	37,0			
ED3750-32-7D-D16/W10	MD-160-EA	WOMT100308-...-D39	32	263	301	60,0	37,5			
ED3800-32-7D-D16/W10	MD-160-EA	WOMT100308-...-D39	32	266	306	60,0	38,0			
ED3810-32-7D-D16/W10	MD-160-EA	WOMT100308-...-D39	32	267	307	60,0	38,1			
ED3900-32-7D-D18/W10	MD-180-EA	WOMT100308-...-D39	32	273	313	60,0	39,0	17-20		
ED3920-32-7D-D18/W10	MD-180-EA	WOMT100308-...-D39	32	275	315	60,0	39,2			
ED3970-32-7D-D18/W10	MD-180-EA	WOMT100308-...-D39	32	278	318	60,0	39,7			
ED4000-50-7D-D18/W10	MD-180-EA	WOMT100308-...-D39	50	280	323	60,0	40			
ED4100-50-7D-D19/W10	MD-190-EA	WOMT100308-...-D39	50	287	330	70,0	41			
ED4128-50-7D-D19/W10	MD-190-EA	WOMT100308-...-D39	50	289	332	70,0	41,28	14-16		
ED4200-50-7D-D19/W10	MD-190-EA	WOMT120408-...-D42	50	294	338	70,0	42,0			
ED4300-S0-7D-D16/W12	MD-160-EA	WOMT120408-...-D42	50	301	345	70,0	43,0			

## RAPID DRILL / RAPID DRILL

## ED...7D YEKPARE TAKIM TUTUCULAR / ED...7D SOLID TOOLHOLDERS

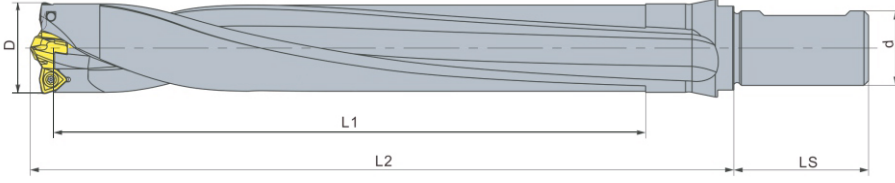

Ürün Kodu Order No	Merkez Matkap Başlığı Çapı Center Drill Head Dia	Yan Uç Side Inserts x2	Boyutlar Dimensions(mm)					Yedek Parça Spare Parts		
			d	L1	L2	Ls	D	Anahtar Key	Vida Screw	Anahtar Wrench
ED4400-50-7D-D18/W12	MD-180-EA	WOMT120408-...-D42	50	308	352	70,0	44,0	17-20	M4X10	T15
ED4445-50-7D-D18/W12	MD-180-EA	WOMT120408-...-D42	50	312	356	70,0	44,5			
ED4500-30-7D-D18/W12	MD-180-EA	WOMT120408-...-D42	50	315	359	70,0	45			
ED4600-50-7D-D19/W12	MD-190-EA	WOMT120408-...-D42	50	322	366	70,0	46,0			
ED4700-50-7D-D20/W12	MD-200-EA	WOMT120408-...-D42	50	329	373	70,0	47,0			
ED4763-30-7D-D21/W12	MD-210-EA	WOMT120408-...-D42	50	334	378	70,0	47,6			
ED4800-50-7D-D21/W12	MD-210-EA	WOMT120408-...-D42	50	336	381	70,0	48,0	21-28		
ED4900-50-7D-D22/W12	MD-220-EA	WOMT120408-...-D42	50	343	388	70,0	49,0			
ED5000-50-7D-D23/W12	MD-230-EA	WOMT120408-...-D42	50	350	395	70,0	50,0			
ED5080-50-7D-D24/W12	MD-240-EA	WOMT120408-...-D42	50	356	401	70,0	50,8			
ED5100-50-7D-D24/W12	MD-240-EA	WOMT120408-...-D42	50	357	402	70,0	51,0			
ED5200-50-7D-D25/W12	MD-250-EA	WOMT120408-...-D42	50	364	409	70,0	52,0			
ED5300-30-7D-D26/W12	MD-260-EA	WOMT120408-...-D42	50	371	416	70,0	53,0			
ED5398-50-7D-D27/W12	MD-270-EA	WOMT120408-...-D42	50	378	423	70,0	54,0			
ED5400-50-7D-D27/W12	MD-270-EA	WOMT120408-...-D42	50	379	424	70,0	54,0			
ED5500-30-7D-D28/W12	MD-280-EA	WOMT120408-...-D42	50	385	430	70,0	55,0			

## RAPID DRILL / RAPID DRILL

### ED...8D YEKPARE TAKIM TUTUCULAR / ED...8D SOLID TOOLHOLDERS

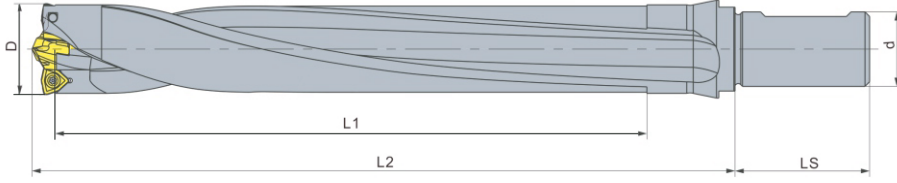

Ürün Kodu Order No	Merkez Matkap Başlığı Çapı Center Drill Head Dia	Yan Uç Side Inserts x2	Boyutlar Dimensions(mm)					Yedek Parça Spare Parts		
			d	L1	L2	Ls	D	Anahtar Key	Vida Screw	Anahtar Wrench
ED2800-32-8D-D14/A04	MD-140-EA	AOMT040308	32	224	258	60,0	28,0	14-16	M2,5X8	T9
ED2858-32-8D-D15/A04	MD-150-EA	AOMT040308	32	229	263	60,0	28,6			
ED2900-32-8D-D16/A04	MD-160-EA	AOMT040308	32	232	266	60,0	29,0			
ED2936-32-8D-D16/A04	MD-160-EA	AOMT040108	32	235	269	60,0	29,4			
ED3000-32-8D-D16/A04	MD-160-EA	AOMT040308	32	240	275	60,0	30,0			
ED3018-32-8D-D17/A04	MD-170-EA	AOMT040308	32	242	277	60,0	30,2	17-20		
ED3096-32-8D-D17/A04	MD-170-EA	AOMT040308	32	248	283	60,0	31,0			
ED3100-32-8D-D17/A04	MD-170-EA	AOMT040308	32	249	284	60,0	31,0			
ED3175-32-8D-D15/W08	MD-150-EA	WOMT080308-...-D33	32	254	291	60,0	31,8	14-16	M3X8	T10
ED3200-32-8D-D15/W08	MD-150-EA	WOMT080308-...-D33	32	256	293	60,0	32,0			
ED3300-32-8D-D16/W08	MD-160-EA	WOMT080308-...-D33	32	264	301	60,0	33,0			
ED3320-32-8D-D16/W08	MD-160-EA	WOMT080308-...-D33	32	266	303	60,0	33,2			
ED3335-32-8D-D16/W08	MD-160-EA	WOMT080308-...-D33	32	267	304	60,0	33,4			
ED3400-32-8D-D16/W08	MD-160-EA	WOMT080308-...-D33	32	272	309	60,0	34,0			
ED3493-32-8D-D18/W08	MD-180-EA	WOMT080308-...-D33	32	280	317	60,0	34,9	17-20		
ED3500-32-8D-D18/W08	MD-180-EA	WOMT080308-...-D33	32	281	319	60,0	35,0			
ED3600-32-8D-D18/W08	MD-180-EA	WOMT080308-...-D33	32	288	326	60,0	36,0			
ED3653-32-8D-D19/W08	MD-190-EA	WOMT080308-...-D33	32	293	331	60,0	36,5	14-16		
ED3700-32-8D-D16/W10	MD-160-EA	WOMT100308-...-D39	32	296	334	60,0	37,0			
ED3750-32-8D-D16/W10	MD-160-EA	WOMT100308-...-D39	32	300	338	60,0	37,5			
ED3800-32-8D-D16/W10	MD-160-EA	WOMT100308-...-D39	32	304	344	60,0	38,0			
ED3810-32-8D-D16/W10	MD-160-EA	WOMT100308-...-D39	32	305	345	60,0	38,1			
ED3900-32-8D-D18/W10	MD-180-EA	WOMT100308-...-D39	32	312	352	60,0	39,0	17-20		
ED3920-32-8D-D18/W10	MD-180-EA	WOMT100308-...-D39	32	314	354	60,0	39,2			
ED3970-32-8D-D18/W10	MD-180-EA	WOMT100308-...-D39	32	318	358	60,0	39,7			
ED4000-50-8D-D18/W10	MD-180-EA	WOMT100308-...-D39	32	320	363	70,0	40,0	14-16		
ED4100-50-8D-D19/W10	MD-190-EA	WOMT100308-...-D39	32	328	371	70,0	41,0			
ED4128-50-8D-D19/W10	MD-190-EA	WOMT100308-...-D39	32	331	374	70,0	41,3			
ED4200-50-8D-D19/W10	MD-190-EA	WOMT120408-...-D42	32	336	380	70,0	42,0			
ED4300-S0-8D-D16/W12	MD-160-EA	WOMT120408-...-D42	32	34	388	70,0	43,0			

## RAPID DRILL / RAPID DRILL

## ED...8D YEKPARE TAKIM TUTUCULAR / ED...8D SOLID TOOLHOLDERS

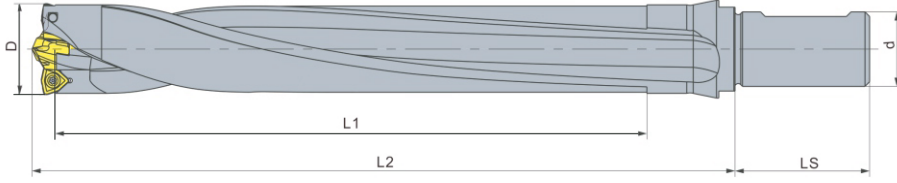

Ürün Kodu Order No	Merkez Matkap Başlığı Çapı Center Drill Head Dia	Yan Uç Side Inserts x2	Boyutlar Dimensions(mm)					Yedek Parça Spare Parts		
			d	L1	L2	Ls	D	Anahtar Key	Vida Screw	Anahtar Wrench
ED4400-50-8D-D18/W12	MD-180-EA	WOMT120408-...-D42	32	352	396	70,0	44,0	17-20	M4X10	T15
ED4445-50-8D-D18/W12	MD-180-EA	WOMT120408-...-D42	32	356	400	70,0	44,5			
ED4500-30-8D-D18/W12	MD-180-EA	WOMT120408-...-D42	32	360	404	70,0	45,0			
ED4600-50-8D-D19/W12	MD-190-EA	WOMT120408-...-D42	32	368	412	70,0	46,0			
ED4700-50-8D-D20/W12	MD-200-EA	WOMT120408-...-D42	32	376	420	70,0	47,0			
ED4763-30-8D-D21/W12	MD-210-EA	WOMT120408-...-D42	32	382	426	70,0	47,6			
ED4800-50-8D-D21/W12	MD-210-EA	WOMT120408-...-D42	32	384	429	70,0	48,0	21-28		
ED4900-50-8D-D22/W12	MD-220-EA	WOMT120408-...-D42	32	392	437	70,0	49,0			
ED5000-50-8D-D23/W12	MD-230-EA	WOMT120408-...-D42	32	400	445	70,0	50,0			
ED5080-S0-8D-D24/W12	MD-240-EA	WOMT120408-...-D42	32	407	452	70,0	50,8			
ED5100-50-8D-D24/W12	MD-240-EA	WOMT120408-...-D42	32	408	453	70,0	51,0			
ED5200-50-8D-D25/W12	MD-250-EA	WOMT120408-...-D42	32	416	461	70,0	52,0			
ED5300-30-8D-D26/W12	MD-260-EA	WOMT120408-...-D42	32	424	469	70,0	53,0			
ED5398-50-8D-D27/W12	MD-270-EA	WOMT120408-...-D42	32	432	477	70,0	54,0			
ED5400-50-8D-D27/W12	MD-270-EA	WOMT120408-...-D42	32	433	478	70,0	54,0			
ED5500-30-8D-D28/W12	MD-280-EA	WOMT120408-...-D42	32	440	485	70,0	55,0			

## RAPID DRILL / RAPID DRILL

### ED...10D YEKPARE TAKIM TUTUCULAR / ED...10D SOLID TOOLHOLDERS

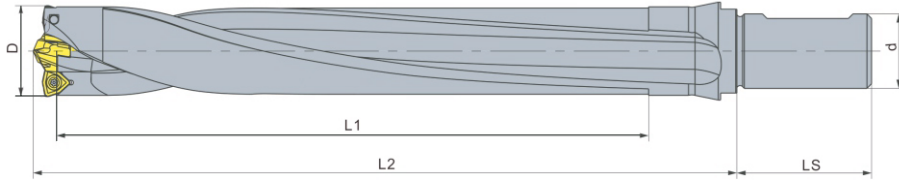

Ürün Kodu Order No	Merkez Matkap Başlığı Çapı Center Drill Head Dia	Yan Uç Side Inserts x2	Boyutlar Dimensions(mm)					Yedek Parça Spare Parts		
			d	L1	L2	Ls	D	Anahtar Key	Vida Screw	Anahtar Wrench
ED2800-32-10D-D14/A04	MD-140-EA	AOMT040308	32	280	314	60,0	28,0	14-16	M2.5X8	T9
ED2858-32-10D-D15/A04	MD-150-EA	AOMT040308	32	286	320	60,0	28,6			
ED2900-32-10D-D16/A04	MD-160-EA	AOMT040308	32	290	324	60,0	29,0			
ED2936-32-10D-D16/A04	MD-160-EA	AOMT040108	32	294	328	60,0	29,4			
ED3000-32-10D-D16/A04	MD-160-EA	AOMT040308	32	300	335	60,0	30,0			
ED3018-32-10D-D17/A04	MD-170-EA	AOMT040308	32	302	337	60,0	30,2	17-20		
ED3096-32-10D-D17/A04	MD-170-EA	AOMT040308	32	310	345	60,0	31,0			
ED3100-32-10D-D17/A04	MD-170-EA	AOMT040308	32	311	346	60,0	31,0			
ED3175-32-10D-D15/W08	MD-150-EA	WOMT080308-...-D33	32	318	355	60,0	31,8	14-16	M3X8	T10
ED3200-32-10D-D15/W08	MD-150-EA	WOMT080308-...-D33	32	320	357	60,0	32,0			
ED3300-32-10D-D16/W08	MD-160-EA	WOMT080308-...-D33	32	330	367	60,0	33,0			
ED3320-32-10D-D16/W08	MD-160-EA	WOMT080308-...-D33	32	332	369	60,0	32,2			
ED3335-32-10D-D16/W08	MD-160-EA	WOMT080308-...-D33	32	334	371	60,0	33,4			
ED3400-32-10D-D16/W08	MD-160-EA	WOMT080308-...-D33	32	340	377	60,0	34,0			
ED3493-32-10D-D18/W08	MD-180-EA	WOMT080308-...-D33	32	350	387	60,0	34,9	17-20		
ED3500-32-10D-D18/W08	MD-180-EA	WOMT080308-...-D33	32	350	388	60,0	35,0			
ED3600-32-10D-D18/W08	MD-180-EA	WOMT080308-...-D33	32	360	398	60,0	36,0			
ED3653-32-10D-D19/W08	MD-190-EA	WOMT080308-...-D33	32	366	404	60,0	36,5	14-16		
ED3700-32-10D-D16/W10	MD-160-EA	WOMT100308-...-D39	32	370	408	60,0	37,0			
ED3750-32-10D-D16/W10	MD-160-EA	WOMT100308-...-D39	32	375	413	60,0	37,5			
ED3800-32-10D-D16/W10	MD-160-EA	WOMT100308-...-D39	32	380	420	60,0	38,0			
ED3810-32-10D-D16/W10	MD-160-EA	WOMT100308-...-D39	32	381	421	60,0	38,1			
ED3900-32-10D-D18/W10	MD-180-EA	WOMT100308-...-D39	32	390	430	60,0	39,0			
ED3920-32-10D-D18/W10	MD-180-EA	WOMT100308-...-D39	32	392	432	60,0	39,2	17-20	M4X10	T15
ED3970-32-10D-D18/W10	MD-180-EA	WOMT100308-...-D39	32	397	437	60,0	39,7			
ED4000-50-10D-D18/W10	MD-180-EA	WOMT100308-...-D39	32	400	443	60,0	40,0			
ED4100-50-10D-D19/W10	MD-190-EA	WOMT100308-...-D39	32	410	453	70,0	41,0	14-16		
ED4128-50-10D-D19/W10	MD-190-EA	WOMT100308-...-D39	32	413	454	70,0	41,3			
ED4200-50-10D-D19/W10	MD-190-EA	WOMT120408-...-D42	32	420	464	70,0	42,0			
ED4300-S0-10D-D16/W12	MD-160-EA	WOMT120408-...-D42	32	430	474	70,0	43,0			

## RAPID DRILL / RAPID DRILL

## ED...10D YEKPARE TAKIM TUTUCULAR / ED...10D SOLID TOOLHOLDERS

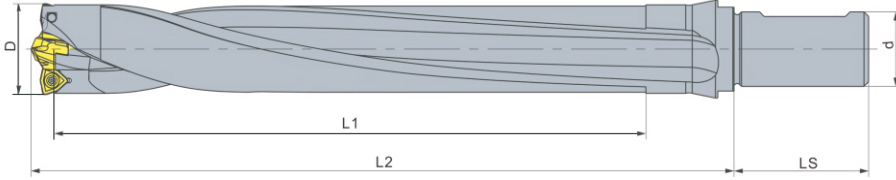

Ürün Kodu Order No	Merkez Matkap Başlığı Çapı Center Drill Head Dia	Yan Uç Side Inserts x2	Boyutlar Dimensions(mm)					Yedek Parça Spare Parts		
			d	L1	L2	Ls	D	Anahtar Key	Vida Screw	Anahtar Wrench
ED4400-50-10D-D18/W12	MD-180-EA	WOMT120408-...-D42	32	440	484	70,0	44,0	17-20	M4X10	T15
ED4445-50-10D-D18/W12	MD-180-EA	WOMT120408-...-D42	32	445	489	70,0	44,5			
ED4500-30-10D-D18/W12	MD-180-EA	WOMT120408-...-D42	32	450	494	70,0	45,0			
ED4600-50-10D-D19/W12	MD-190-EA	WOMT120408-...-D42	32	460	504	70,0	46,0			
ED4700-50-10D-D20/W12	MD-200-EA	WOMT120408-...-D42	32	470	514	70,0	47,0			
ED4763-30-10D-D21/W12	MD-210-EA	WOMT120408-...-D42	32	477	521	70,0	47,6			
ED4800-50-10D-D21/W12	MD-210-EA	WOMT120408-...-D42	32	480	525	70,0	48,0	21-28		
ED4900-50-10D-D22/W12	MD-220-EA	WOMT120408-...-D42	32	490	535	70,0	49,0			
ED5000-50-10D-D23/W12	MD-230-EA	WOMT120408-...-D42	32	500	545	70,0	50,0			
ED5080-50-10D-D24/W12	MD-240-EA	WOMT120408-...-D42	32	508	553	70,0	50,8			
ED5100-50-10D-D24/W12	MD-240-EA	WOMT120408-...-D42	32	510	555	70,0	51,0			
ED5200-50-10D-D25/W12	MD-250-EA	WOMT120408-...-D42	32	520	565	70,0	52,0			
ED5300-30-10D-D26/W12	MD-260-EA	WOMT120408-...-D42	32	530	575	70,0	53,0			
ED5398-50-10D-D27/W12	MD-270-EA	WOMT120408-...-D42	32	540	585	70,0	54,0			
ED5400-50-10D-D27/W12	MD-270-EA	WOMT120408-...-D42	32	541	586	70,0	54,0			
ED5500-30-10D-D28/W12	MD-280-EA	WOMT120408-...-D42	32	550	595	70,0	55,0			

## RAPID DRILL / RAPID DRILL

### ÇOK UÇ HATTI MODÜLER TAKIM TUTUCU KOD SİSTEMİ

#### MULTI INSERT LINE MODULAR TOOLHOLDER CODE SYSTEM

- Kesme Ünitesi Sipariş Kodu Sistemi / Cutting Unit Ordering Code System

# ED

1

# 3300

2

# D16

3

# W08

4

1 ED 3300 D16 W08

ED: E-DRILL  
Kesme Birimi  
Cutting Unit

2 ED 3300 D16 W08

Matkap Çapı  
Drill Dia.  
30,0 mm(28-55)

3 ED 3300 D16 W08

Merkez Matkap Başlığı Çapı  
Center Drill Head Dia.  
16 mm

4 ED 3300 D16 W08

Kesici Uç Geniřliđi 8 mm  
Side Insert Length 8 mm

- Tutucu Birim Sipariş Kodu Sistemi / Holder Unit Ordering Code System

# ED

1

# 31

2

# 32

3

# 3D

4

1 ED 31 32 3D

ED: E-DRILL  
Tutucu Birimi  
Holder Unit

2 ED 31 32 3D

Tutucu Çapı  
Holder Dia.  
mm

3 ED 31 32 3D

Sap Çapı  
Shank Dia.  
32,0 mm

4 ED 31 32 3D

Tutucu Uzunluđu  
Holder Length

## RAPID DRILL / RAPID DRILL

## MD...EA MERKEZ MATKAP UCU / MD...EA CENTER DRILL INSERT

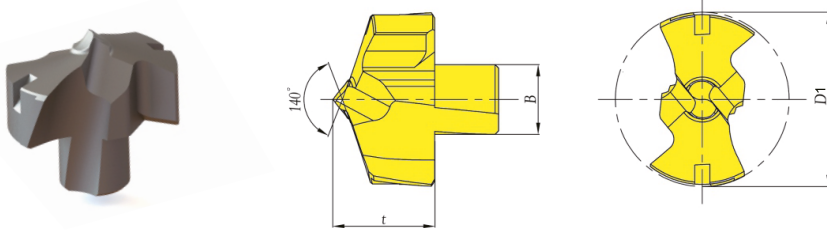

Ürün Kodu Order Code	Boyutlar Dimensions (mm)		
	D	D1	R
MD-150-EA	15	6	8.7
MD-160-EA	16	8	8.8
MD-170-EA	17	8	9.9
MD-180-EA	18	8	10,5
MD-190-EA	19	8	11,5
MD-200-EA	20	8	11,6
MD-210-EA	21	8	12,1
MD-220-EA	22	10	12,7
MD-230-EA	23	10	13,3
MD-240-EA	24	12	13,9
MD-250-EA	25	12	14,5
MD-260-EA	26	12	14,5
MD-270-EA	27	12	15,5
MD-280-EA	28	12	15,5
MD-290-EA	29	14	15,5
MD-300-EA	30	14	15,5
MD-310-EA	31	14	15,5
MD-320-EA	32	14	16,5
MD-330-EA	33	14	16,5
MD-340-EA	34	14	16,5

## RAPID DRILL / RAPID DRILL

### WOMT... W... YAN UÇLAR / WOMT... W... SIDE INSERTS

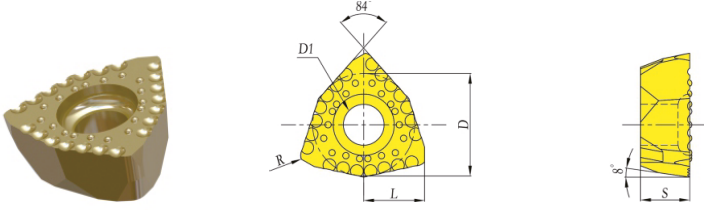

Ürün Kodu Order Code	Boyutlar Dimensions (mm)			
	D	D1	R	S
WOMT080308-W6-D33	8	3,4	0,8	3,75
WOMT100308-W6-D39	10	4,4	0,8	3,75
WOMT120408-W6-D42	12	4,4	0,8	4,75
WOMT150508-W6-D55	15	5,5	0,8	5,25

### WOMT... V... YAN UÇLAR / WOMT... V... SIDE INSERTS

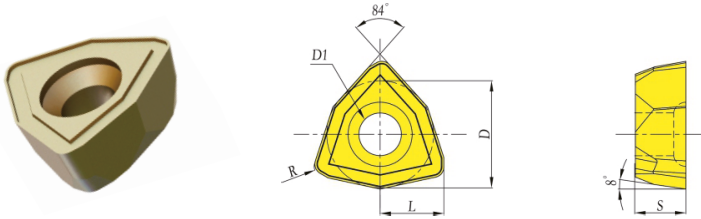

Ürün Kodu Order Code	Boyutlar Dimensions (mm)			
	D	D1	R	S
WOMT080308-V1-D33	8	3,4	0,8	3,75
WOMT100308-V1-D39	10	4,4	0,8	3,75
WOMT120408-V1-D42	12	4,4	0,8	4,75
WOMT150508-V1-DSC	15	5,5	0,8	5,25
WOMT080308-V2-D33	8	3,4	0,8	3,75
WOMT100308-V2-D39	10	4,4	0,8	3,75
WOMT120408-V2-D42	12	4,4	0,8	4,75
WOMT150508-V2-DSC	15	5,5	0,8	5,25

RAPID DRILL / RAPID DRILL

AOMT YAN UÇLAR / AOMT SIDE INSERTS

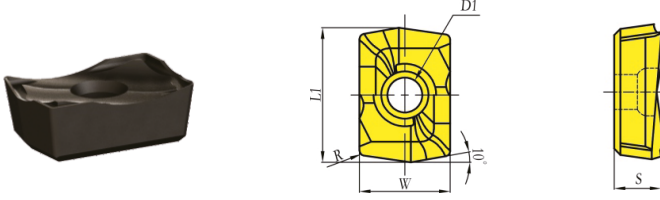

Ürün Kodu Order Code	Boyutlar Dimensions (mm)				
	W	L1	D1	R	S
AOMT040308	7,26	10,76	2,85	0,4	3,79

WOMT... W... YAN UÇLAR / WOMT... W... SIDE INSERTS

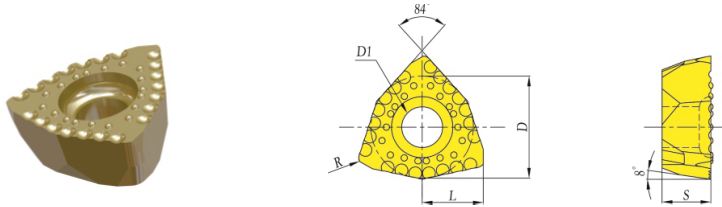

Ürün Kodu Order Code	Boyutlar Dimensions (mm)			
	D	D1	R	S
WOMT080308-W5-D33	8	3,4	0,8	3,75
WOMT100308-W5-D39	10	4,4	0,8	3,75
WOMT120408-W5-D42	12	4,4	0,8	4,75
WOMT150508-W5-D55	15	5,5	0,8	5,25

## RAPID DRILL / RAPID DRILL

### 3D... TAKIM TUTUCULAR / 3D... TOOLHOLDERS

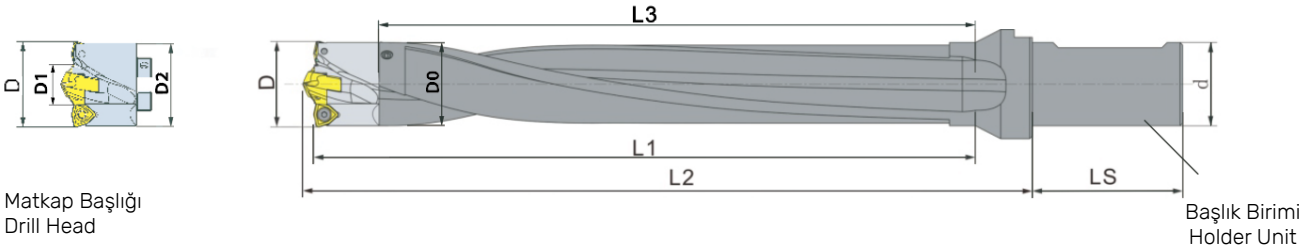

Kesici Birimi Cutting Unit	Matkap Çapı D Drill Dia D(mm)	Merkez Matkap Başlığı Çapı D1 Center Drill Head Dia D0	Yan Uç Side Inserts x1	Tutucu Birimi Holder Unit	Boyutlar Dimensions (mm)							Arayüzey Kodu Interface Code	Yedek Parça Spare Parts		
					D2	D0	d	L1	L2	L3	L4		Anahtar Key	Vida Screw	Anahtar Wrench
E2800-D14/A04	28,00	MD-140-EA	AOMT040308	S27-32-3D	27,5	27	32	95	134	75	60	IF28	14-16	M2,5x8	T9
E2858-D15/A04	28,58	MD-150-EA	AOMT040308		27,5	27	32	95	134	75	60				
E2900-D16/A04	29,00	MD-160-EA	AOMT040308		27,5	27	32	95	134	75	60				
E2936-D16/A04	29,36	MD-160-EA	AOMT040308		27,5	27	32	95	134	75	60				
E3000-D16/A04	30,00	MD-160-EA	AOMT040308	S29-32-3D	29,5	29	32	100	138	80	60	IF28	17-20	M2,5x8	T9
E3018-D17/A04	30,18	MD-170-EA	AOMT040308		29,5	29	32	100	138	80	60				
E3096-D17/A04	30,96	MD-170-EA	AOMT040308		29,5	29	32	100	138	80	60				
E3100-D17/A04	31,00	MD-170-EA	AOMT040308		29,5	29	32	100	138	80	60				
E3175-D15/W08	31,75	MD-150-EA	WOMT080308...-D33	S31-32-3D	31,3	30,8	32	112	148	90	60	IF32	14-16	M3X10	T10
E3200-D15/W08	32,00	MD-150-EA	WOMT080308...-D33		31,3	30,8	32	112	148	90	60				
E3300-D15/W08	33,00	MD-160-EA	WOMT080308...-D33		31,3	30,8	32	112	148	90	60				
E3320-D15/W08	33,20	MD-160-EA	WOMT080308...-D33		31,3	30,8	32	112	148	90	60				
E3335-D15/W08	33,35	MD-160-EA	WOMT080308...-D33	S34-32-3D	31,3	30,8	32	112	148	90	60	IF32	17-20	M3X10	T10
E3400-D16/W08	34,00	MD-160-EA	WOMT080308...-D33		31,3	30,8	32	112	148	90	60				
E3493-D18/W08	34,93	MD-180-EA	WOMT080308...-D33		31,3	30,8	32	112	148	90	60				
E3500-D18/W08	35,00	MD-180-EA	WOMT080308...-D33		34,5	34	32	122	160	100	60				
E3600-D18/W08	36,00	MD-180-EA	WOMT080308...-D33	S37-32-3D	34,5	34	32	122	160	100	60	IF38	14-16	M3X10	T10
E3653-D19/W08	36,53	MD-190-EA	WOMT080308...-D33		34,5	34	32	122	160	100	60				
E3700-D16/W10	37,00	MD-160-EA	WOMT080308...-D33		34,5	34	32	122	160	100	60				
E3750-D16/W10	37,50	MD-160-EA	WOMT080308...-D33		34,5	34	32	122	160	100	60				
E3800-D16/W10	38,00	MD-160-EA	WOMT080308...-D33	S39-50-3D	37,5	37	32	125	165	100	60	IF38	17-20	M3X10	T10
E3810-D16/W10	38,10	MD-160-EA	WOMT080308...-D33		37,5	37	32	125	165	100	60				
E3900-D18/W10	39,00	MD-180-EA	WOMT080308...-D33		37,5	37	32	125	165	100	60				
E3920-D18/W10	39,20	MD-180-EA	WOMT080308...-D33		37,5	37	32	125	165	100	60				
E3970-D18/W10	39,70	MD-180-EA	WOMT080308...-D33	S39-50-3D	37,5	37	32	125	165	100	60	IF38	17-20	M3X10	T10
E4000-D18/W10	40,00	MD-180-EA	WOMT080308...-D33		39,5	39	50	135	180	110	70				
E4100-D19/W10	41,00	MD-190-EA	WOMT080308...-D33		39,5	39	50	135	180	110	70				
E4128-D19/W10	41,28	MD-190-EA	WOMT080308...-D33	S39-50-3D	39,5	39	50	135	180	110	70	IF38	17-20	M3X10	T10

## RAPID DRILL / RAPID DRILL

## 3D... TAKIM TUTUCULAR / 3D... TOOLHOLDERS

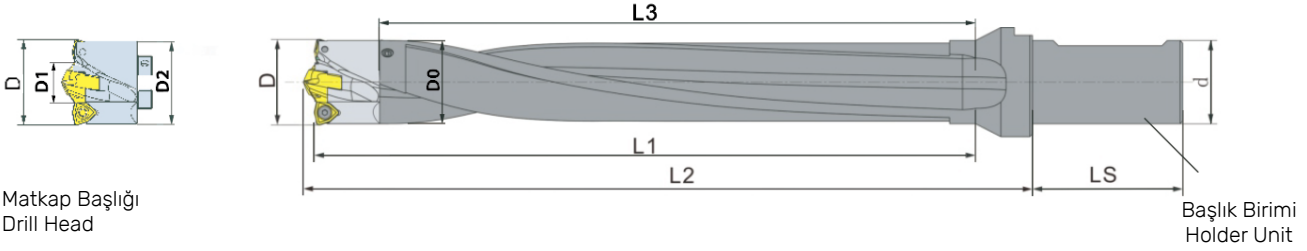

Kesici Birimi Cutting Unit	Matkap Çapı D Drill Dia D(mm)	Merkez Matkap Başlığı Çapı D1 Center Drill Head Dia D0	Yan Uç Side Inserts x1	Tutucu Birimi Holder Unit	Boyutlar Dimensions (mm)							Arayüzey Kodu Interface Code	Yedek Parça Spare Parts		
					D2	D0	d	L1	L2	L3	LS		Anahtar Key	Vida Screw	Anahtar Wrench
E4200-D19/W10	42,00	MD-190-EA	WOMT120408--D42	S41-50-3D	41,5	41	50	140	185	115	70	IF42	14-16	M4X12	T15
E4300-D16/W12	43,00	MD-160-EA	WOMT120408--D42		41,5	41	50	140	185	115	70				
E4400-D18/W12	44,00	MD-180-EA	WOMT120408--D42		41,5	41	50	140	185	115	70				
E4445-D18/W12	44,45	MD-180-EA	WOMT120408--D42		41,5	41	50	140	185	115	70				
E4500-D18/W12	45,00	MD-180-EA	WOMT120408--D42	S44-50-3D	44,5	44	50	150	195	124	70	IF42	17-20	M4X12	T15
E4600-D19/W12	46,00	MD-190-EA	WOMT120408--D42		44,5	44	50	150	195	124	70				
E4700-D20/W12	47,00	MD-200-EA	WOMT120408--D42		44,5	44	50	150	195	124	70				
E4763-D21/W12	47,63	MD-210-EA	WOMT120408--D42		44,5	44	50	150	195	124	70				
E4800-D21/W12	48,00	MD-210-EA	WOMT120408--D42	S47-50-3D	47	47	50	160	200	135	70	IF48	21-28	M4X12	T15
E4900-D22/W12	49,00	MD-220-EA	WOMT120408--D42		47	47	50	160	200	135	70				
E5000-D23/W12	50,00	MD-230-EA	WOMT120408--D42		47	47	50	160	200	135	70				
E5080-D24/W12	50,80	MD-240-EA	WOMT120408--D42	S50-50-3D	49,8	49,8	50	170	210	135	70	IF48	21-28	M4X12	T15
E5100-D24/W12	51,00	MD-240-EA	WOMT120408--D42		49,8	49,8	50	170	210	135	70				
E5200-D25/W12	52,00	MD-250-EA	WOMT120408--D42		49,8	49,8	50	170	210	135	70				
E5300-D26/W12	53,00	MD-260-EA	WOMT120408--D42		49,8	49,8	50	170	210	135	70				
E5398-D27/W12	53,98	MD-270-EA	WOMT120408--D42	S53-50-3D	53,4	53	50	175	215	140	70	IF48	21-28	M4X12	T15
E5400-D27/W12	54,00	MD-270-EA	WOMT120408--D42		53,4	53	50	175	215	140	70				
E5550-D28/W12	55,00	MD-280-EA	WOMT120408--D42		53,4	53	50	175	215	140	70				

## RAPID DRILL / RAPID DRILL

### 5D... TAKIM TUTUCULAR / 5D... TOOLHOLDERS

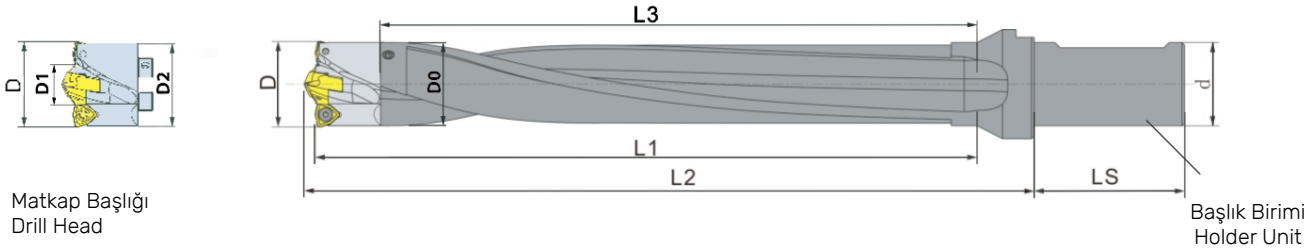

Kesici Birimi Cutting Unit	Matkap Çapı D Drill Dia D(mm)	Merkez Matkap Başlığı Çapı D1 Center Drill Head Dia D0	Yan Uç Side Inserts x1	Tutucu Birimi Holder Unit	Boyutlar Dimensions (mm)							Arayüzey Kodu Interface Code	Yedek Parça Spare Parts		
					D2	D0	d	L1	L2	L3	LS		Anahtar Key	Vida Screw	Anahtar Wrench
E2800-D14/A04	28	MD-140-EA	AOMT040308	S27-32-5D	27,5	27	32	155	194	135	60	IF28	14-16	M2,5X8	T9
E2858-D15/A04	28,58	MD-150-EA	AOMT040308		27,5	27	32	155	194	135	60				
E2900-D16/A04	29	MD-160-EA	AOMT040308		27,5	27	32	155	194	135	60				
E2936-D16/A04	29,36	MD-160-EA	AOMT040308		27,5	27	32	155	194	135	60				
E3000-D16/A04	30	MD-160-EA	AOMT040308	S29-32-5D	29,5	29	32	160	199	140	60	IF28	17-20	M2,5X8	T9
E3018-D17/A04	30,18	MD-170-EA	AOMT040308		29,6	29	32	160	199	140	60				
E3096-D17/A04	30,96	MD-170-EA	AOMT040308		29,7	29	32	160	199	140	60				
E3100-D17/A04	31	MD-170-EA	AOMT040308		29,8	29	32	160	199	140	60				
E3175-D15/W08	31,75	MD-150-EA	WOMT080308-...-D33	S31-32-5D	31,3	30,8	32	177	212	155	60	IF32	14-16	M3X10	T10
E3200-D13/W08	32	MD-150-EA	WOMT080308-...-D33		31,3	30,8	32	177	212	155	60				
E3300-D16/W08	33	MD-160-EA	WOMT080308-...-D33		31,3	30,8	32	177	212	155	60				
E3320-D16/W08	33,2	MD-160-EA	WOMT080308-...-D33		31,3	30,8	32	177	212	155	60				
E3333-D16/W08	33,33	MD-160-EA	WOMT080308-...-D33	S34-32-5D	31,3	30,8	32	177	212	155	60	IF32	17-20	M3X10	T10
E3400-D16/W08	34	MD-160-EA	WOMT080308-...-D31		31,3	30,8	32	177	212	155	60				
E3493-D18/W08	34,93	MD-180-EA	WOMT080308-...-D33		31,3	30,8	32	177	212	155	60				
E3500-D18/W08	35	MD-180-EA	WOMT080308-...-D33		34,5	34	32	192	230	170	60				
E3600-D18/W08	36,00	MD-180-EA	WOMT080308-...-D33	S37-32-5D	34,5	34	32	192	230	170	60	IF8	14-16	M3X10	T10
E3653-D19/W08	36,53	MD-190-EA	WOMT080308-...-D33		34,5	34	32	192	230	170	60				
E3700-D16/W10	37	MD-160-EA	WOMT100308-...-D39		34,5	34	32	192	230	170	60				
E3730-D16/W10	37,5	MD-160-EA	WOMT100308-...-D39		34,5	34	32	192	230	170	60				
E3800-D16/W10	38	MD-160-EA	WOMT100308-...-D39	S39-50-5D	37,5	37	32	215	245	190	60	IF8	17-20	M3X10	T10
E3810-D16/W10	38,1	MD-160-EA	WOMT100308-...-D39		37,5	37	32	215	245	190	60				
E3900-D18/W10	39	MD-180-EA	WOMT100308-...-D39		37,5	37	32	213	243	190	60				
E3920-D18/W10	39,2	MD-180-EA	WOMT100308-...-D39		37,5	37	32	215	245	190	60				
E3970-D18/W10	39,7	MD-180-EA	WOMT100308-...-D39	S39-50-5D	37,5	37	32	215	245	190	60	IF8	17-20	M3X10	T10
E4000-D18/W10	40	MD-180-EA	WOMT100308-...-D39		39,5	39	50	220	265	195	70				
E4100-D19/W10	41	MD-190-EA	WOMT100308-...-D39		39,5	39	50	220	265	195	70				
E4128-D19/W10	41,28	MD-190-EA	WOMT100308-...-D39	S39-50-5D	39,5	39	50	220	265	195	70	IF8	17-20	M3X10	T10

## RAPID DRILL / RAPID DRILL

## 5D... TAKIM TUTUCULAR / 5D... TOOLHOLDERS

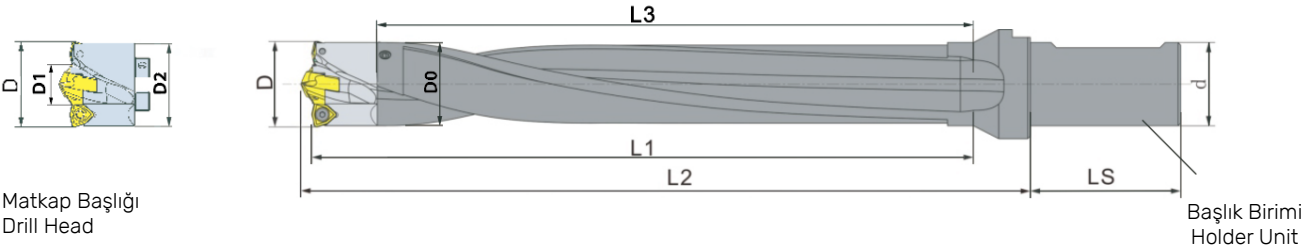

Kesici Birimi Cutting Unit	Matkap Çapı D Drill Dia D(mm)	Merkez Matkap Başlığı Çapı D1 Center Drill Head Dia D0	Yan Uç Side Inserts x1	Tutucu Birimi Holder Unit	Boyutlar Dimensions (mm)							Arayüzey Kodu Interface Code	Yedek Parça Spare Parts		
					D2	D0	d	L1	L2	L3	LS		Anahtar Key	Vida Screw	Anahtar Wrench
E4200-D19/W10	42	MD-190-EA	WOMT120408-...-D42	S41-50-5D	41.5	41	50	230	277	205	70	IF42	14-16	M4X12	T15
E4300-D16/W12	43	MD-160-EA	WOMT120408-...-D42		41.5	41	50	230	277	205	70				
E4400-D18/W12	44	MD-180-EA	WOMT120408-...-D42		41.5	41	50	230	277	205	70				
E4445-D18/W12	44,45	MD-180-EA	WOMT120408-...-D42		41.5	41	50	230	277	205	70				
E4S00-D18/W12	45	MD-180-EA	WOMT120408-...-D42	S47-50-5D	44.5	44	50	243	283	219	70	IF42	17-20	M4X12	T15
E4600-D19/W12	46,00	MD-190-EA	WOMT120408-...-D42		44.5	44	50	243	283	219	70				
E4700-D20/W12	47	MD-200-EA	WOMT120408-...-D42		44.5	44	50	243	283	219	70				
E4763-D21/W12	47,63	MD-210-EA	WOMT120408-...-D42		44.5	44	50	243	283	219	70				
E4800-D21/W12	48	MD-210-EA	WOMT120408-...-D42	547-50-5D	47,5	47	50	260	305	225	70	IF48	21-28	M4X12	T15
E4900-D22/W12	49	MD-220-EA	WOMT120408-...-D42		47,5	47	50	260	305	225	70				
E5000-D23/W12	50	MD-230-EA	WOMT120408-...-D42	S50-50-5D	47,5	47	50	260	305	225	70	IF48	21-28	M4X12	T15
E5080-D24/W12	50,8	MD-240-EA	WOMT120408-...-D42		50,3	49,8	50	275	315	240	70				
E5100-D24/W12	51	MD-240-EA	WOMT120408-...-D42		50,3	49,8	50	275	315	240	70				
E5200-D25/W12	52	MD-250-EA	WOMT120408-...-D42		50,3	49,8	50	275	315	240	70				
E5300-D26/W12	53	MD-260-EA	WOMT120408-...-D42	S53-50-5D	50,3	49,8	50	275	315	240	70	IF48	21-28	M4X12	T15
E5398-D27/W12	53,98	MD-270-EA	WOMT120408-...-D42		53,4	53	50	280	320	245	70				
E5400-D27/W12	54	MD-270-EA	WOMT120408-...-D42		53,4	53	50	280	320	245	70				
E5500-D28/W12	55	MD-280-EA	WOMT120408-...-D42		53,4	53	50	280	320	245	70				

## RAPID DRILL / RAPID DRILL

### 6D... TAKIM TUTUCULAR / 6D... TOOLHOLDERS

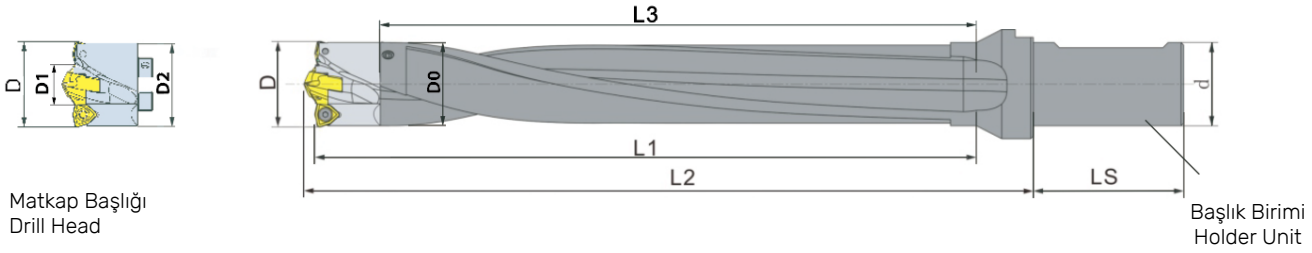

Kesici Birimi Cutting Unit	Matkap Çapı D Drill Dia D(mm)	Merkez Matkap Başlığı Çapı D1 Center Drill Head Dia D0	Yan Uç Side Inserts x1	Tutucu Birimi Holder Unit	Boyutlar Dimensions (mm)								Arayüzey Kodu Interface Code	Yedek Parça Spare Parts		
					D2	D0	d	L1	L2	L3	LS	Anahtar Key		Vida Screw	Anahtar Wrench	
E2800-D14/A04	28	MD-140-EA	AOMT040308	S27-32-6D	27,5	27	32	180	220	160	60	IF28	14-16	M2,5X8	T9	
E2858-D15/A04	28,58	MD-150-EA	AOMT040308		27,5	27	32	180	220	160	60					
E2900-D16/A04	29	MD-160-EA	AOMT040308		27,5	27	32	180	220	160	60					
E2936-D16/A04	29,36	MD-160-EA	AOMT040308		27,5	27	32	180	220	160	60					
E3000-D16/A04	30	MD-160-EA	AOMT040308	S29-32-6D	29,5	29	32	195	23	175	60	IF28	17-20	M2,5X8	T9	
E3018-D17/A04	30,18	MD-170-EA	AOMT040308		29,5	29	32	195	23	175	60					
E3096-D17/A04	30,96	MD-170-EA	AOMT040308		29,5	29	32	195	23	175	60					
E3100-D17/A04	31	MD-170-EA	AOMT040308		29,5	29	32	195	23	175	60					
E3175-D15/W08	31,75	MD-150-EA	WOMT080308-...-D33	S31-32-6D	31,3	30,8	32	211	246	189	60	IF32	14-16	M3X10	T10	
E3200-D13/W08	32	MD-150-EA	WOMT080308-...-D33		31,3	30,8	32	211	246	189	60					
E3300-D16/W08	33	MD-160-EA	WOMT080308-...-D33		31,3	30,8	32	211	246	189	60					
E3320-D16/W08	33,2	MD-160-EA	WOMT080308-...-D73		31,3	30,8	32	211	246	189	60					
E3333-D16/W08	33,33	MD-160-EA	WOMT080308-...-D33	S34-32-6D	31,3	30,8	32	211	246	189	60	IF32	17-20	M3X10	T10	
E3400-D16/W08	34	MD-160-EA	WOMT080308-...-D31		31,3	30,8	32	211	246	189	60					
E3493-D18/W08	34,93	MD-180-EA	WOMT080308-...-D33		31,3	30,8	32	211	246	189	60					
E3500-D18/W08	35	MD-180-EA	WOMT080308-...-D33		34,5	34	32	227	265	205	60					
E3600-D18/W08	36,00	MD-180-EA	WOMT080308-...-D33	S34-32-6D	34,5	34	32	227	265	205	60	IF32	17-20	M3X10	T10	
E3653-D19/W08	36,53	MD-190-EA	WOMT080308-...-D33		34,5	34	32	227	265	205	60					
E3700-D16/W10	37	MD-160-EA	WOMT100308-...-D39		34,5	34	32	227	265	205	60					
E3730-D16/W10	37,5	MD-160-EA	WOMT100308-...-D39		34,5	34	32	227	265	205	60					
E3800-D16/W10	38	MD-160-EA	WOMT100308-...-D39	S37-32-6D	37,5	37	32	255	290	230	60	IF8	14-16	M3X10	T10	
E3810-D16/W10	38,1	MD-160-EA	WOMT100308-...-D79		37,5	37	32	255	290	230	60					
E3900-D18/W10	39	MD-180-EA	WOMT100308-...-D39		37,5	37	32	255	290	230	60					
E3920-D18/W10	39,2	MD-180-EA	WOMT100308-...-D39		37,5	37	32	255	290	230	60					
E3970-D18/W10	39,7	MD-180-EA	WOMT100308-...-D39	S39-50-6D	37,5	37	32	255	290	230	60	IF8	17-20	M3X10	T10	
E4000-D18/W10	40	MD-180-EA	WOMT100308-...-D39		39,5	39	50	257	305	232	70					
E4100-D19/W10	41	MD-190-EA	WOMT100308-...-D39		39,5	39	50	257	305	232	70					
E4128-D19/W10	41,28	MD-190-EA	WOMT100308-...-D39		39,5	39	50	257	305	232	70					

## RAPID DRILL / RAPID DRILL

## 6D... TAKIM TUTUCULAR / 6D... TOOLHOLDERS

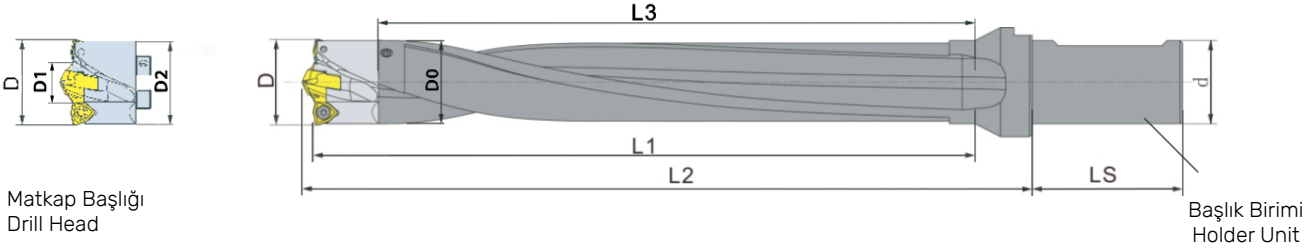

Kesici Birimi Cutting Unit	Matkap Çapı D Drill Dia D(mm)	Merkez Matkap Başlığı Çapı D1 Center Drill Head Dia D0	Yan Uç Side Inserts x1	Tutucu Birimi Holder Unit	Boyutlar Dimensions (mm)							Arayüzey Kodu Interface Code	Yedek Parça Spare Parts			
					D2	D0	d	L1	L2	L3	LS		Anahtar Key	Vida Screw	Anahtar Wrench	
E4200-D19/W10	42	MD-190-EA	WOMT120408-...-D42	S41-50-6D	41.5	41	50	275	320	250	70	IF42	14-16	M4X12	T15	
E4300-D16/W12	43	MD-160-EA	WOMT120408-...-D42		41.5	41	50	275	320	250	70					
E4400-D18/W12	44	MD-180-EA	WOMT120408-...-D42		41.5	41	50	275	320	250	70					
E4445-D18/W12	44,45	MD-180-EA	WOMT120408-...-D42		41.5	41	50	275	320	250	70					
E4500-D18/W12	45	MD-180-EA	WOMT120408-...-D42	S47-50-6D	44.5	44	50	295	350	269	70		17-20			
E4600-D19/W12	46,00	MD-190-EA	WOMT120408-...-D42		44.5	44	50	295	350	269	70					
E4700-D20/W12	47	MD-200-EA	WOMT120408-...-D42		44.5	44	50	295	350	269	70					
E4763-D21/W12	47,63	MD-210-EA	WOMT120408-...-D42		44.5	44	50	295	350	269	70					
E4800-D21/W12	48	MD-210-EA	WOMT120408-...-D42	S47-50-6D	47.5	47	50	310	350	275	70		IF48			21-28
E4900-D22/W12	49	MD-220-EA	WOMT120408-...-D42		47.5	47	50	310	350	275	70					
E5000-D23/W12	50	MD-230-EA	WOMT120408-...-D42		47.5	47	50	310	350	275	70					
E5080-D24/W12	50,8	MD-240-EA	WOMT120408-...-D42		S50-50-6D	50.3	49.8	50	330	370	295	70				
E5100-D24/W12	51	MD-240-EA	WOMT120408-...-D42	50.3		49.8	50	330	370	295	70					
E5200-D25/W12	52	MD-250-EA	WOMT120408-...-D42	50.3		49.8	50	330	370	295	70					
E5300-D26/W12	53	MD-260-EA	WOMT120408-...-D42	50.3		49.8	50	330	370	295	70					
E5398-D27/W12	53,98	MD-270-EA	WOMT120408-...-D42	S53-50-6D	53.4	53	50	340	380	305	70	IF48	21-28			
E5400-D27/W12	54	MD-270-EA	WOMT120408-...-D42		53.4	53	50	340	380	305	70					
E5500-D28/W12	55	MD-280-EA	WOMT120408-...-D42		53.4	53	50	340	380	305	70					

## RAPID DRILL / RAPID DRILL

### 7D... TAKIM TUTUCULAR / 7D... TOOLHOLDERS

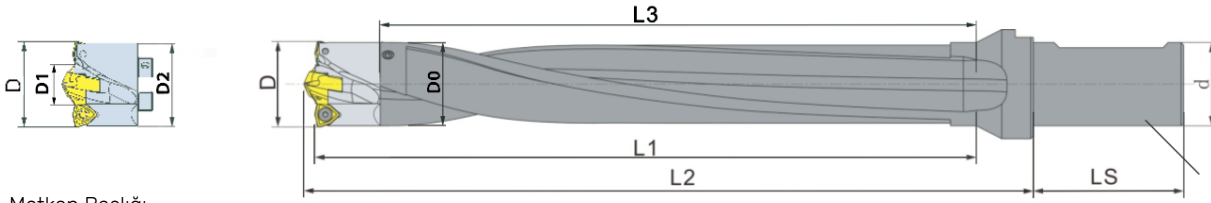

Matkap Başlığı  
Drill Head

Başlık Birimi  
Holder Unit

Kesici Birimi Cutting Unit	Matkap Çapı D Drill Dia D(mm)	Merkez Matkap Başlığı Çapı D1 Center Drill Head Dia D0	Yan Uç Side Inserts x1	Tutucu Birimi Holder Unit	Boyutlar Dimensions (mm)								Arayüzey Kodu Interface Code	Yedek Parça Spare Parts		
					D2	D0	d	L1	L2	L3	LS	Anahtar Key		Vida Screw	Anahtar Wrench	
E2800-D14/A04	28,00	MD-140-EA	AOMT040308	S27-32-7D	27,5	27	32	215	255	195	60	IF28	14-16	M2.5X8	T9	
E2858-D15/A04	28,58	MD-150-EA	AOMT040308		27,5	27	32	215	255	195	60					
E2900-D16/A04	29,00	MD-160-EA	AOMT040308		27,5	27	32	215	255	195	60					
E2936-D16/A04	29,36	MD-160-EA	AOMT040308		27,5	27	32	215	255	195	60					
E3000-D16/A04	30,00	MD-160-EA	AOMT040308	S29-32-7D	29,5	29	32	220	258	200	60	IF28	17-20	M2.5X8	T9	
E3018-D17/A04	30,18	MD-170-EA	AOMT040308		29,5	29	32	220	258	200	60					
E3096-D17/A04	30,96	MD-170-EA	AOMT040308		29,5	29	32	220	258	200	60					
E3100-D17/A04	31,00	MD-170-EA	AOMT040308		29,5	29	32	220	258	200	60					
E3175-D15/W08	31,75	MD-150-EA	WOMT080308-...-D33	S31-32-7D	31,3	30,8	32	251	286	229	60	IF32	14-16	M3X10	T10	
E3200-D13/W08	32,00	MD-150-EA	WOMT080308-...-D33		31,3	30,8	32	251	286	229	60					
E3300-D16/W08	33,00	MD-160-EA	WOMT080308-...-D33		31,3	30,8	32	251	286	229	60					
E3320-D16/W08	33,20	MD-160-EA	WOMT080308-...-D73		31,3	30,8	32	251	286	229	60					
E3333-D16/W08	33,33	MD-160-EA	WOMT080308-...-D33	S34-32-7D	31,3	30,8	32	251	286	229	60	IF32	17-20	M3X10	T10	
E3400-D16/W08	34,00	MD-160-EA	WOMT080308-...-D31		31,3	30,8	32	251	286	229	60					
E3493-D18/W08	34,93	MD-180-EA	WOMT080308-...-D33		31,3	30,8	32	251	286	229	60					
E3500-D18/W08	35,00	MD-180-EA	WOMT080308-...-D33		34,5	34	32	272	308	250	60					
E3600-D18/W08	36,00	MD-180-EA	WOMT080308-...-D33	S37-32-7D	34,5	34	32	272	308	250	60	IF8	14-16	M3X10	T10	
E3653-D19/W08	36,53	MD-190-EA	WOMT080308-...-D33		34,5	34	32	272	308	250	60					
E3700-D16/W10	37,00	MD-160-EA	WOMT100308-...-D39		34,5	34	32	272	308	250	60					
E3730-D16/W10	37,50	MD-160-EA	WOMT100308-...-D39		34,5	34	32	272	308	250	60					
E3800-D16/W10	38,00	MD-160-EA	WOMT100308-...-D39	S39-50-7D	37,5	37	32	295	329	270	60	IF8	17-20	M3X10	T10	
E3810-D16/W10	38,10	MD-160-EA	WOMT100308-...-D79		37,5	37	32	295	329	270	60					
E3900-D18/W10	39,00	MD-180-EA	WOMT100308-...-D39		37,5	37	32	295	329	270	60					
E3920-D18/W10	39,20	MD-180-EA	WOMT100308-...-D39		37,5	37	32	295	329	270	60					
E3970-D18/W10	39,70	MD-180-EA	WOMT100308-...-D39	S39-50-7D	37,5	37	32	295	329	270	60	IF8	17-20	M3X10	T10	
E4000-D18/W10	40,00	MD-180-EA	WOMT100308-...-D39		39,5	39	50	300	343	275	70					
E4100-D19/W10	41,00	MD-190-EA	WOMT100308-...-D39		39,5	39	50	300	343	275	70					
E4128-D19/W10	41,28	MD-190-EA	WOMT100308-...-D39		39,5	39	50	300	343	275	70					

## RAPID DRILL / RAPID DRILL

## 7D... TAKIM TUTUCULAR / 7D... TOOLHOLDERS

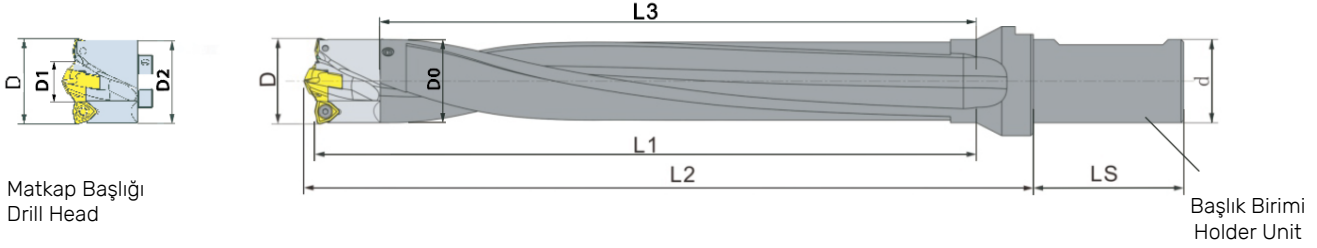

Kesici Birimi Cutting Unit	Matkap Çapı D Drill Dia D(mm)	Merkez Matkap Başlığı Çapı D1 Center Drill Head Dia D0	Yan Uç Side Inserts x1	Tutucu Birimi Holder Unit	Boyutlar Dimensions (mm)								Arayüzey Kodu Interface Code	Yedek Parça Spare Parts		
					D2	D0	d	L1	L2	L3	LS	Anahtar Key		Vida Screw	Anahtar Wrench	
E4200-D19/W10	42,00	MD-190-EA	WOMT120408-...-D42	S41-50-7D	41,5	41	50	320	360	295	70	IF42	14-16	M4X12	T15	
E4300-D16/W12	43,00	MD-160-EA	WOMT120408-...-D42		41,5	41	50	320	360	295	70					
E4400-D18/W12	44,00	MD-180-EA	WOMT120408-...-D42		41,5	41	50	320	360	295	70					
E4445-D18/W12	44,45	MD-180-EA	WOMT120408-...-D42		41,5	41	50	320	360	295	70					
E4S00-D18/W12	45,00	MD-180-EA	WOMT120408-...-D42	S47-50-7D	44,5	44	50	346	390	320	70	IF42	17-20	M4X12	T15	
E4600-D19/W12	46,00	MD-190-EA	WOMT120408-...-D42		44,5	44	50	346	390	320	70					
E4700-D20/W12	47,00	MD-200-EA	WOMT120408-...-D42		44,5	44	50	346	390	320	70					
E4763-D21/W12	47,63	MD-210-EA	WOMT120408-...-D42		44,5	44	50	346	390	320	70					
E4800-D21/W12	48,00	MD-210-EA	WOMT120408-...-D42	547-50-7D	47,5	47	50	360	400	325	70	IF48	21-28			
E4900-D22/W12	49,00	MD-220-EA	WOMT120408-...-D42		47,5	47	50	360	400	325	70					
E5000-D23/W12	50,00	MD-230-EA	WOMT120408-...-D42		47,5	47	50	360	400	325	70					
E5080-D24/W12	50,80	MD-240-EA	WOMT120408-...-D42	S50-50-7D	50,3	49,8	50	375	415	340	70	IF48	21-28			
E5100-D24/W12	51,00	MD-240-EA	WOMT120408-...-D42		50,3	49,8	50	375	415	340	70					
E5200-D25/W12	52,00	MD-250-EA	WOMT120408-...-D42		50,3	49,8	50	375	415	340	70					
E5300-D26/W12	53,00	MD-260-EA	WOMT120408-...-D42		50,3	49,8	50	375	415	340	70					
E5398-D27/W12	53,98	MD-270-EA	WOMT120408-...-D42	S53-50-7D	53,4	53	50	385	425	350	70	IF48	21-28			
E5400-D27/W12	54,00	MD-270-EA	WOMT120408-...-D42		53,4	53	50	385	425	350	70					
E5500-D28/W12	55,00	MD-280-EA	WOMT120408-...-D42		53,4	53	50	385	425	350	70					

## RAPID DRILL / RAPID DRILL

## 8D... TAKIM TUTUCULAR / 8D... TOOLHOLDERS

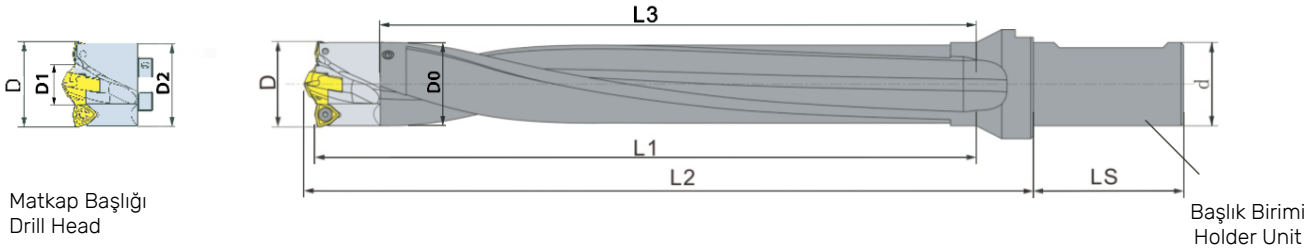

Matkap Başlığı  
Drill Head

Başlık Birimi  
Holder Unit

Kesici Birimi Cutting Unit	Matkap Çapı D Drill Dia D(mm)	Merkez Matkap Başlığı Çapı D1 Center Drill Head Dia D0	Yan Uç Side Inserts x1	Tutucu Birimi Holder Unit	Boyutlar Dimensions (mm)								Arayüzey Kodu Interface Code	Yedek Parça Spare Parts		
					D2	D0	d	L1	L2	L3	LS	Anahtar Key		Vida Screw	Anahtar Wrench	
E2800-D14/A04	28	MD-140-EA	AOMT040308	S27-32-8D	27.5	27	32	300	340	280	60	IF28	14-16	M2.5X8	T9	
E2858-D15/A04	28,58	MD-150-EA	AOMT040308													
E2900-D16/A04	29	MD-160-EA	AOMT040308													
E2936-D16/A04	29,36	MD-160-EA	AOMT040308													
E3000-D16/A04	30	MD-160-EA	AOMT040308	S29-32-8D	29.5	29	32	310	348	w	60	IF28	17-20			
E3018-D17/A04	30,18	MD-170-EA	AOMT040308													
E3096-D17/A04	30,96	MD-170-EA	AOMT040308													
E3100-D17/A04	31	MD-170-EA	AOMT040308													
E3175-D15/W08	31,75	MD-150-EA	WOMT080308-...-D33	S31-32-8D	31,25	30,75	32	349	384	327	60	IF32	14-16	M3X10	T10	
E3200-D13/W08	32	MD-150-EA	WOMT080308-...-D33													
E3300-D16/W08	33	MD-160-EA	WOMT080308-...-D33													
E3320-D16/W08	33,2	MD-160-EA	WOMT080308-...-D33													
E3333-D16/W08	33,33	MD-160-EA	WOMT080308-...-D33	S34-32-8D	34,5	34	32	382	412	360	60	IF32	17-20			
E3400-D16/W08	34	MD-160-EA	WOMT080308-...-D31													
E3493-D18/W08	34,93	MD-180-EA	WOMT080308-...-D33													
E3500-D18/W08	35	MD-180-EA	WOMT080308-...-D33													
E3600-D18/W08	36,00	MD-180-EA	WOMT080308-...-D33	S37-32-8D	37,5	37	32	412	443	387	60	IF8	14-16			
E3653-D19/W08	36,53	MD-190-EA	WOMT080308-...-D33													
E3700-D16/W10	37	MD-160-EA	WOMT100308-...-D39													
E3730-D16/W10	37,5	MD-160-EA	WOMT100308-...-D39													
E3800-D16/W10	38	MD-160-EA	WOMT100308-...-D39	S39-50-8D	39,5	39	50	425	480	400	70	IF8	17-20			
E3810-D16/W10	38,1	MD-160-EA	WOMT100308-...-D39													
E3900-D18/W10	39	MD-180-EA	WOMT100308-...-D39													
E3920-D18/W10	39,2	MD-180-EA	WOMT100308-...-D39													
E3970-D18/W10	39,7	MD-180-EA	WOMT100308-...-D39	S39-50-8D	39,5	39	50	425	480	400	70	IF8	17-20			
E4000-D18/W10	40	MD-180-EA	WOMT100308-...-D39													
E4100-D19/W10	41	MD-190-EA	WOMT100308-...-D39													
E4128-D19/W10	41,28	MD-190-EA	WOMT100308-...-D39													

## RAPID DRILL / RAPID DRILL

## 8D... TAKIM TUTUCULAR / 8D... TOOLHOLDERS

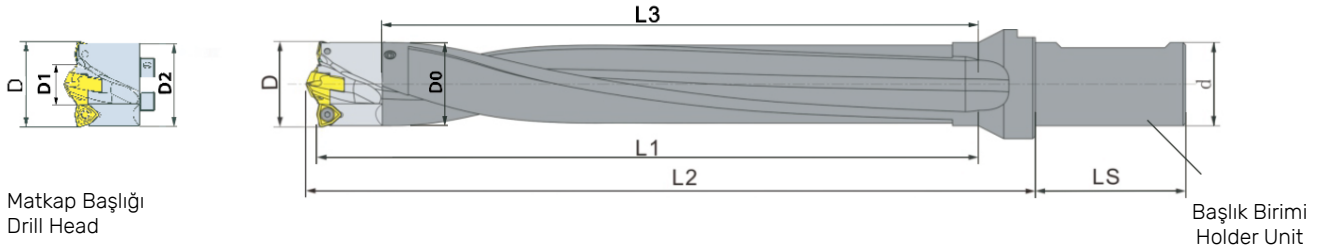

Kesici Birimi Cutting Unit	Matkap Çapı D Drill Dia D(mm)	Merkez Matkap Başlığı Çapı D1 Center Drill Head Dia D0	Yan Uç Side Inserts x1	Tutucu Birimi Holder Unit	Boyutlar Dimensions (mm)								Arayüzey Kodu Interface Code	Yedek Parça Spare Parts			
					D2	D0	d	L1	L2	L3	LS	Anahtar Key		Vida Screw	Anahtar Wrench		
E4200-D19/W10	42	MD-190-EA	WOMT120408-...-D42	S41-50-8D	41.5	41	50	455	500	430	70	IF42	14-16	M4X12	T15		
E4300-D16/W12	43	MD-160-EA	WOMT120408-...-D42														
E4400-D18/W12	44	MD-180-EA	WOMT120408-...-D42														
E4445-D18/W12	44,45	MD-180-EA	WOMT120408-...-D42														
E4S00-D18/W12	45	MD-180-EA	WOMT120408-...-D42	S47-50-8D	44.5	44	50	485	530	459	70		IF48	17-20	M4X12	T15	
E4600-D19/W12	46.00	MD-190-EA	WOMT120408-...-D42														
E4700-D20/W12	47	MD-200-EA	WOMT120408-...-D42														
E4763-D21/W12	47.63	MD-210-EA	WOMT120408-...-D42														
E4800-D21/W12	48	MD-210-EA	WOMT120408-...-D42	S47-50-8D	47.5	47	50	510	550	475	70			IF48	21-28	M4X12	T15
E4900-D22/W12	49	MD-220-EA	WOMT120408-...-D42														
E5000-D23/W12	50	MD-230-EA	WOMT120408-...-D42														
E5080-D24/W12	50,8	MD-240-EA	WOMT120408-...-D42														
E5100-D24/W12	51	MD-240-EA	WOMT120408-...-D42	S50-50-8D	50.3	49.8	50	530	570	495	70	IF48			21-28	M4X12	T15
E5200-D25/W12	52	MD-250-EA	WOMT120408-...-D42														
E5300-D26/W12	53	MD-260-EA	WOMT120408-...-D42														
E5398-D27/W12	53,98	MD-270-EA	WOMT120408-...-D42														
E5400-D27/W12	54	MD-270-EA	WOMT120408-...-D42	S53-50-8D	53.4	53	50	550	590	515	70		IF48		21-28	M4X12	T15
E5500-D28/W12	55	MD-280-EA	WOMT120408-...-D42														

## RAPID DRILL / RAPID DRILL

### 10D... TAKIM TUTUCULAR / 10D... TOOLHOLDERS

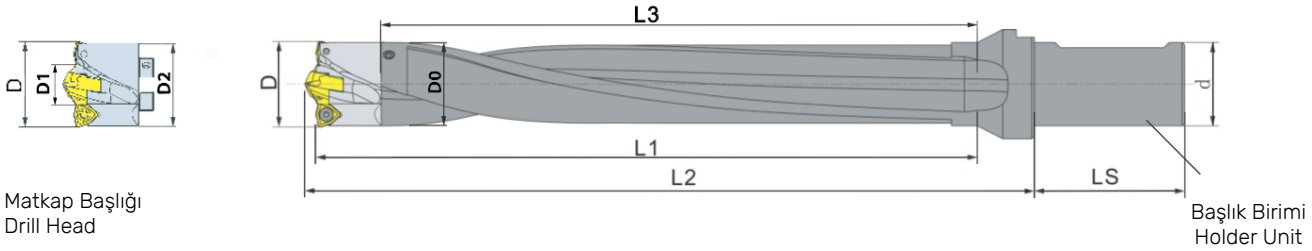

Kesici Birimi Cutting Unit	Matkap Çapı D Drill Dia D(mm)	Merkez Matkap Başlığı Çapı D1 Center Drill Head Dia D0	Yan Uç Side Inserts x1	Tutucu Birimi Holder Unit	Boyutlar Dimensions (mm)								Arayüzey Kodu Interface Code	Yedek Parça Spare Parts		
					D2	D0	d	L1	L2	L3	LS	Anahtar Key		Vida Screw	Anahtar Wrench	
E2800-D14/A04	28,00	MD-140-EA	AOMT040308	S27-32-10D	27,5	27	32	245	285	225	60	IF28	14-16	M2.5X8	T9	
E2858-015/A04	28,58	MD-150-EA	AOMT040308		27,5	27	32	245	285	225	60					
E2900-D16/A04	29,00	MD-160-EA	AOMT040308		27,5	27	32	245	285	225	60					
E2936-D16/A04	29,36	MD-160-EA	AOMT040308		27,5	27	32	245	285	225	60					
E3000-D16/A04	30,00	MD-160-EA	AOMT040308	S29-32-10D	29,5	29	32	250	288	230	60	IF28	17-20	M2.5X8	T9	
E3018-D17/A04	30,18	MD-170-EA	AOMT040308		29,5	29	32	250	288	230	60					
E3096-D17/A04	30,96	MD-170-EA	AOMT040308		29,5	29	32	250	288	230	60					
E3100-D17/A04	31,00	MD-170-EA	AOMT040308		29,5	29	32	250	288	230	60					
E3175-D15/W08	31,75	MD-150-EA	WOMT080308- ...-D33	S31-32-10D	31,3	31	32	279	314	257	60	IF32	14-16	M3X10	T10	
E3200-D13/W08	32,00	MD-150-EA	WOMT080308- ...-D33		31,3	31	32	279	314	257	60					
E3300-D16/W08	33,00	MD-160-EA	WOMT080308- ...-D33		31,3	31	32	279	314	257	60					
E3320-D16/W08	33,20	MD-160-EA	WOMT080308- ...-D33		31,3	31	32	279	314	257	60					
E3333-D16/W08	33,33	MD-160-EA	WOMT080308- ...-D33	S34-32-10D	31,3	31	32	279	314	257	60	IF32	17-20	M3X10	T10	
E3400-D16/W08	34,00	MD-160-EA	WOMT080308- ...-D31		31,3	31	32	279	314	257	60					
E3493-D18/W08	34,93	MD-180-EA	WOMT080308- ...-D33		31,3	31	32	279	314	257	60					
E3500-D18/W08	35,00	MD-180-EA	WOMT080308- ...-D33		34,5	34	32	312	348	290	60					
E3600-D18/W08	36,00	MD-180-EA	WOMT080308- ...-D33	S37-32-10D	34,5	34	32	312	348	290	60	IF8	14-16	M4X12	T15	
E3653-D19/W08	36,53	MD-190-EA	WOMT080308- ...-D33		34,5	34	32	312	348	290	60					
E3700-D16/WI 0	37,00	MD-160-EA	WOMTI 00308- ...-D39		34,5	34	32	312	348	290	60					
E3730-D16/WI 0	37,50	MD-160-EA	WOMTI 00308- ...-D39		34,5	34	32	312	348	290	60					
E3800-D16/WI 0	38,00	MD-160-EA	WOMTI 00308- ...-D39	S39-32-10D	37,5	37	32	335	366	310	60	IF8	17-2D 14-16 17-2D	M4X12	T15	
E3810-D16/WID	38,10	MD-160-EA	WOMTI 00308- ...-D39		37,5	37	32	335	366	310	60					
E3900-D18/WI 0	39,00	MD-180-EA	WOMTI 00308- ...-D39		37,5	37	32	335	366	310	60					
E3920-D18/WI 0	39,20	MD-180-EA	WOMTI 00308- ...-D39		37,5	37	32	335	366	310	60					
E3970-D18/WI 0	39,70	MD-180-EA	WOMTI 00308- ...-D39	S39-32-10D	37,5	37	32	335	366	310	60	IF8	17-2D 14-16 17-2D	M4X12	T15	
E4000-D18/WI 0	40,00	MD-180-EA	WOMTI 003D8- ...-D39		39,5	39	50	345	395	320	70					
E4100-D19/WI 0	41,00	MD-190-EA	WOMTI 00308- ...-D39		39,5	39	50	345	395	320	70					
E4128-D19/WI 0	41,28	MD-190-EA	WOMTI 003D8- ...-D39		39,5	39	50	345	395	320	70					

## RAPID DRILL / RAPID DRILL

## 10D... TAKIM TUTUCULAR / 10D... TOOLHOLDERS

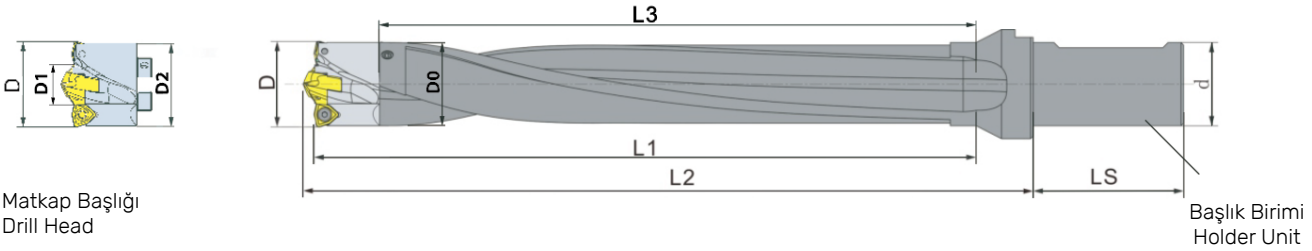

Kesici Birimi Cutting Unit	Matkap Çapı D Drill Dia D(mm)	Merkez Matkap Başlığı Çapı D1 Center Drill Head Dia D0	Yan Uç Side Inserts x1	Tutucu Birimi Holder Unit	Boyutlar Dimensions (mm)								Arayüzey Kodu Interface Code	Yedek Parça Spare Parts		
					D2	D0	d	L1	L2	L3	LS	Anahtar Key		Vida Screw	Anahtar Wrench	
E4200-D19/WI 0	42,00	MD-190-EA	WOMTI 20408-...-D42	S41-32-10D	41.5	41	50	365	405	340	7D	IF42	17-2D 14-16 17-2D	M4X12	T15	
E4300-D16/WI 2	43,00	MD-160-EA	WOMTI 20408-...-D42		41.5	41	50	365	405	340	7D					
E4400-D18/WI 2	44,00	MD-180-EA	WOMTI 20408-...-D42		41.5	41	50	365	405	340	7D					
E4445-D18/WI 2	44,45	MD-180-EA	WOMTI 20408-...-D42		41.5	41	50	365	405	340	7D					
E4S00-D18/WI 2	45,00	MD-180-EA	WOMTI 20408-...-D42	S47-32-10D	44.5	44	50	390	435	364	7D	IF48	21-28	M4X12	T15	
E4600-D19/WI 2	46,00	MD-190-EA	WOMTI 20408-...-D42		44.5	44	50	390	435	364	7D					
E4700-D20/WI 2	47,00	MD-200-EA	WOMTI 20408-...-D42		44.5	44	50	390	435	364	7D					
E4763-D21/WI 2	47,63	MD-210-EA	WOMTI 20408-...-D42		44.5	44	50	390	435	364	7D					
E480D-D21/WI2	48,00	MD-210-EA	WOMTI 20408-...-D42	547-50-10D	47.5	47	50	410	450	375	7D	IF48	21-28	M4X12	T15	
E4900-D22/WI 2	49,00	MD-220-EA	WOMTI 20408-...-D42		47.5	47	50	410	450	375	7D					
E5000-D23/WI 2	50,00	MD-230-EA	WOMTI 20408-...-D42		47.5	47	50	410	450	375	7D					
E5080-D24/WI 2	50,80	MD-240-EA	WOMTI 20408-...-D42	S50-50-10D	50.3	49.8	50	425	465	390	7D	IF48	21-28	M4X12	T15	
E5100-D24/WI 2	51,00	MD-240-EA	WOMTI 20408-...-D42		50.3	49.8	50	425	465	390	7D					
E5200-D25/WI 2	52,00	MD-250-EA	WOMTI 20408-...-D42		50.3	49.8	50	425	465	390	7D					
E5300-D26/WI 2	53,00	MD-260-EA	WOMTI 20408-...-D42		50.3	49.8	50	425	465	390	7D					
E5398-D27/WI 2	53,98	MD-270-EA	WOMTI 20408-...-D42	S53-50-111D	53.4	53	50	440	480	405	7D	IF48	21-28	M4X12	T15	
E5400-D27/WI 2	54,00	MD-270-EA	WOMTI 20408-...-D42		53.4	53	50	440	480	405	7D					
E5500-D28/WI 2	55,00	MD-280-EA	WOMTI 20408-...-D42		53.4	53	50	440	480	405	7D					

## RAPID DRILL / RAPID DRILL

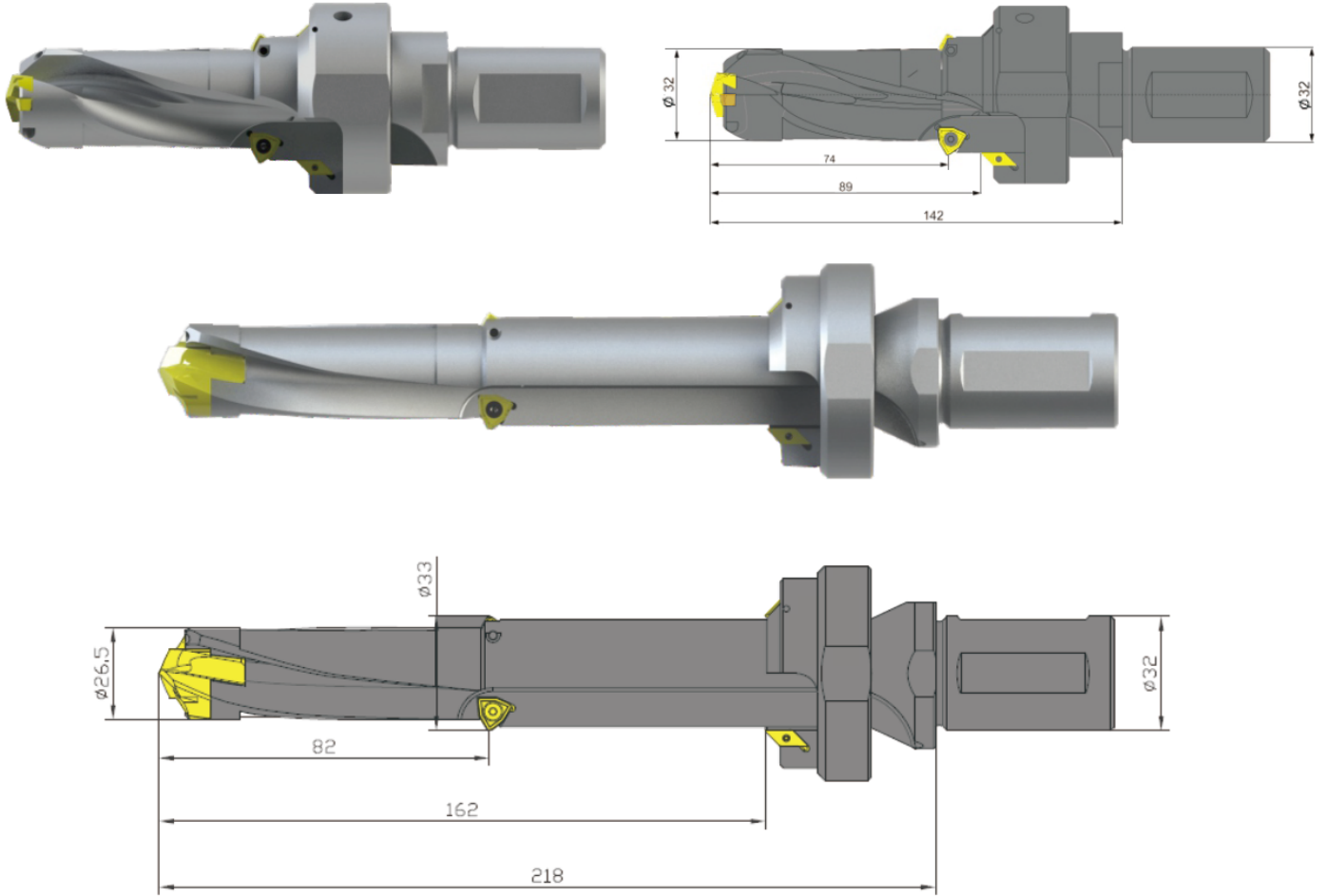
SOĞUTMA DELİKLİ ÇOK UÇLU KADEMELİ MATKAP TAKIMLARI  
SPECIAL MULTI-INSERT STEP DRILL TOOLHOLDERS WITH COOLANT

\*Euroloy müşterinin ihtiyaçlarına göre özel çok uçlu delme takımları tasarlar ve üretir.

\*Euroloy can design and produce special multi-insert drilling tools according to customer's requests.

## RAPID DRILL / RAPID DRILL

## ÇOKLU UÇ TEKNİK BİLGİ / MULTI INSERT TECHNICAL INFORMATION

Materyal Materials	Isı Tedavisi Heat Treatment	VC m/min		Metrik Sistem Metric System				
				(F mm/r)				
		min	max	28,00-31,74mm	31,75-35,99mm	36,00-44,99mm	45,00-55,00mm	
P	2	S	90	230	0,160-0,280	0,160-0,280	0,200-0,360	0,200-0,400
		U	70	170	0,160-0,280	0,160-0,280	0,200-0,360	0,200-0,400
		I	50	110	0,160-0,280	0,160-0,280	0,200-0,320	0,200-0,400
	3	S	90	230	0,160-0,280	0,160-0,280	0,200-0,320	0,200-0,400
		U	70	170	0,160-0,280	0,160-0,280	0,200-0,320	0,200-0,400
		I	50	106	0,160-0,280	0,160-0,280	0,200-0,320	0,200-0,400
	4	S	90	220	0,160-0,280	0,160-0,280	0,200-0,320	0,200-0,400
		U	70	160	0,160-0,280	0,160-0,280	0,200-0,320	0,200-0,400
		I	50	110	0,160-0,280	0,160-0,280	0,200-0,320	0,200-0,400
	5	S	90	210	0,160-0,280	0,160-0,280	0,200-0,320	0,200-0,400
		U	70	150	0,160-0,280	0,160-0,280	0,200-0,320	0,200-0,400
		I	50	100	0,160-0,280	0,160-0,280	0,200-0,320	0,200-0,400
6	S	90	180	0,160-0,280	0,160-0,280	0,200-0,320	0,200-0,400	
	U	75	120	0,160-0,280	0,160-0,280	0,200-0,320	0,200-0,400	
	I	60	100	0,160-0,280	0,160-0,280	0,200-0,320	0,200-0,400	
M	1	S	110	135	0,130-0,250	0,130-0,250	0,160-0,280	0,160-0,320
		U	70	90	0,130-0,250	0,130-0,250	0,160-0,280	0,160-0,320
		I	50	65	0,130-0,250	0,130-0,250	0,160-0,280	0,160-0,320
	2	S	100	135	0,130-0,250	0,130-0,250	0,160-0,280	0,160-0,320
		U	60	90	0,130-0,250	0,130-0,250	0,160-0,280	0,160-0,320
		I	50	65	0,130-0,250	0,130-0,250	0,160-0,280	0,160-0,320
	3	S	90	135	0,130-0,250	0,130-0,250	0,160-0,280	0,160-0,320
		U	60	90	0,130-0,250	0,130-0,250	0,160-0,280	0,160-0,320
		I	40	65	0,130-0,250	0,130-0,250	0,160-0,280	0,160-0,320
K	1	S	170	230	0,180-0,300	0,180-0,300	0,216-0,360	0,240-0,420
		U	120	160	0,180-0,300	0,180-0,300	0,216-0,360	0,240-0,420
		I	70	90	0,180-0,300	0,180-0,300	0,216-0,360	0,240-0,420
	2	S	160	220	0,180-0,300	0,180-0,300	0,216-0,360	0,240-0,420
		U	110	160	0,180-0,300	0,180-0,300	0,216-0,360	0,240-0,420
		I	70	100	0,180-0,300	0,180-0,300	0,216-0,360	0,240-0,420
3	S	150	210	0,180-0,300	0,180-0,300	0,216-0,360	0,240-0,420	
	U	100	150	0,180-0,300	0,180-0,300	0,216-0,360	0,240-0,420	
	I	660	90	0,180-0,300	0,180-0,300	0,216-0,360	0,240-0,420	
N	1	S	240	360	0,120-0,200	0,120-0,200	0,144-0,280	0,160-0,320
		U	160	240	0,120-0,200	0,120-0,200	0,144-0,280	0,160-0,320
		I	100	160	0,120-0,200	0,120-0,200	0,144-0,280	0,160-0,320
	2	S	220	360	0,120-0,200	0,120-0,200	0,144-0,280	0,160-0,320
		U	150	240	0,120-0,200	0,120-0,200	0,144-0,280	0,160-0,320
		I	100	160	0,120-0,200	0,120-0,200	0,144-0,280	0,160-0,320
	3	S	200	360	0,120-0,200	0,120-0,200	0,144-0,280	0,160-0,320
		U	140	240	0,120-0,200	0,120-0,200	0,144-0,280	0,160-0,320
		I	90	160	0,120-0,200	0,120-0,200	0,144-0,280	0,160-0,320
	4	S	220	260	0,120-0,200	0,120-0,200	0,144-0,280	0,160-0,320
		U	140	170	0,120-0,200	0,120-0,200	0,144-0,280	0,160-0,320
		I	90	110	0,120-0,200	0,120-0,200	0,144-0,280	0,160-0,320

Engineered for Excellence.

#EuroloyExcellence



### Italy Office / İtalya Ofis



Via Leonardo Da Vinci, 4 – 20054  
Milano MI ITALIA



(+39) 0282398309



info@euroloy.com

### Turkey Office / Türkiye Ofis



Üsküdar Cad. YEDPA No:1  
Ataşehir -İstanbul -TÜRKİYE



(+90) 850 933 3408



euroloytr@euroloy.com