

KOMPLE KARBÜR TAKIMLAR

SOLID CARBIDE
TOOLS

2026 | CATALOG

www.euroloy.com

 **EUROLOY**
CARBIDE TOOLS





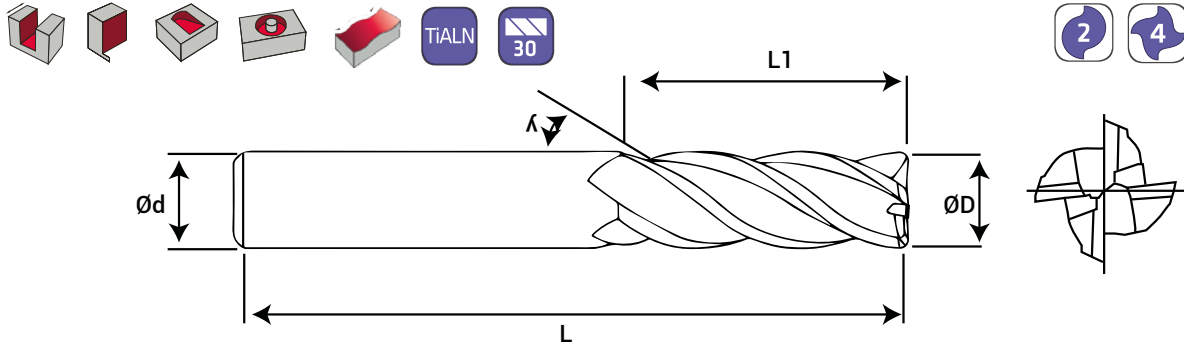
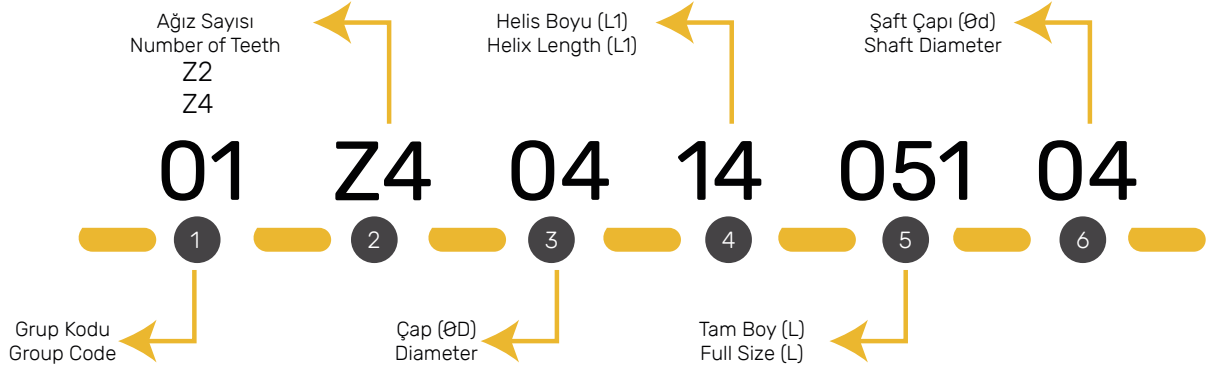













KARBÜR FREZELEME KODLAMA SİSTEMİ





CARBIDE ENDMILL CODING SYSTEM



Grup Kodu / Group Code			
1	01 Z4 04 14 051 04		
01	Karbür Düz Freze (45HRC) Flat Carbide Endmill (45HRC)	03	Karbür Küre Freze (45HRC & 60HRC) Ball Nose Carbide Endmill (45HRC & 60HRC)
02	Karbür Uzun Düz Freze (45HRC) Long Flat Carbide Endmill (45HRC)	04	Karbür Uzun Küre Freze (45HRC & 60HRC) Ball Nose Long Carbide Endmill (45HRC & 60HRC)
03	Karbür Pirr Freze (60HRC) Carbide Pirr Endmill (60HRC)	05	Karbür Köşe Radyüs Freze (55≤HRC) Corner Radius Carbide Endmill (55≤HRC)
04	Karbür Köşe Radyüs Uzun Freze (55≤HRC) Corner Radius Long Carbide Endmill (55≤HRC)	06	Karbür Alüminyum Uzun Finiş Freze Long Carbide Aluminium Finishing Endmill
05	Karbür Alüminyum Performans Freze Carbide Aluminium Performance Endmill	07	Karbür Alüminyum Uzun Performans Freze Long Carbide Aluminium Performance Endmill
06	Karbür Alüminyum Uzun Küre Freze Ball Nose Long Carbide Aluminium Endmill	08	Karbür Kaba Talaş Freze Ball Roughing Endmill
07	Karbür Alüminyum Uzun Performans Freze Long Carbide Aluminium Performance Endmill	09	Karbür Uzun Kaba Talaş Freze Long Roughing Endmill
08	Karbür Kaba Talaş Freze Ball Roughing Endmill	10	Karbür Uzun Kaba Talaş Freze Long Roughing Endmill
09	Karbür Uzun Kaba Talaş Freze Long Roughing Endmill	11	Karbür Uzun Kaba Talaş Freze Long Roughing Endmill
10	Karbür Uzun Kaba Talaş Freze Long Roughing Endmill	12	Karbür İç Bükey Freze Carbide Rounding Concave Cutter
11	Karbür Uzun Kaba Talaş Freze Long Roughing Endmill	13	Karbür Uzun Kaba Talaş Freze Long Roughing Endmill
12	Karbür Uzun Kaba Talaş Freze Long Roughing Endmill	14	Karbür Uzun Kaba Talaş Freze Long Roughing Endmill
13	Karbür Uzun Kaba Talaş Freze Long Roughing Endmill	15	Karbür Uzun Kaba Talaş Freze Long Roughing Endmill
14	Karbür Uzun Kaba Talaş Freze Long Roughing Endmill	16	Karbür Uzun Kaba Talaş Freze Long Roughing Endmill
15	Karbür Uzun Kaba Talaş Freze Long Roughing Endmill	17	Karbür Uzun Kaba Talaş Freze Long Roughing Endmill
16	Karbür Uzun Kaba Talaş Freze Long Roughing Endmill	18	Karbür Uzun Kaba Talaş Freze Long Roughing Endmill
17	Karbür Uzun Kaba Talaş Freze Long Roughing Endmill	19	Karbür Uzun Kaba Talaş Freze Long Roughing Endmill
18	Karbür Uzun Kaba Talaş Freze Long Roughing Endmill	20	Karbür Uzun Kaba Talaş Freze Long Roughing Endmill
19	Karbür Uzun Kaba Talaş Freze Long Roughing Endmill	21	Karbür Uzun Kaba Talaş Freze Long Roughing Endmill
20	Karbür Uzun Kaba Talaş Freze Long Roughing Endmill	22	Karbür Uzun Kaba Talaş Freze Long Roughing Endmill
21	Karbür Uzun Kaba Talaş Freze Long Roughing Endmill	23	Karbür Uzun Kaba Talaş Freze Long Roughing Endmill
22	Karbür Uzun Kaba Talaş Freze Long Roughing Endmill	24	Karbür Uzun Kaba Talaş Freze Long Roughing Endmill
23	Karbür Uzun Kaba Talaş Freze Long Roughing Endmill	25	Karbür Uzun Kaba Talaş Freze Long Roughing Endmill
24	Karbür Uzun Kaba Talaş Freze Long Roughing Endmill	26	Karbür Uzun Kaba Talaş Freze Long Roughing Endmill
25	Karbür Uzun Kaba Talaş Freze Long Roughing Endmill	27	Karbür Uzun Kaba Talaş Freze Long Roughing Endmill
26	Karbür Uzun Kaba Talaş Freze Long Roughing Endmill	28	Karbür Uzun Kaba Talaş Freze Long Roughing Endmill
27	Karbür Uzun Kaba Talaş Freze Long Roughing Endmill		
28	Karbür Uzun Kaba Talaş Freze Long Roughing Endmill		

★ Önerilir / Recommended
○ Kullanılabilir / Acceptable

Takım Kodu No Team No	Ürün Product	Çubuk Kalitesi Rod Grade	Resim Image	Sayfa Page	Kaplama Coating	Kullanım Alanı Application Area	Ağız Sayısı Number of Teeth	İş Parçası / Workpiece					
								P	M	K	N	S	H
								Çelik-Steel	Paslanmaz Çelik Stainless Steel	Dökme Demir Cast Iron	Demir Dışı Metal Non-ferrous Metal	Isıya Dirençli Alaşım Heat Resistant Alloy	Sertleştirilmiş Çelik Hardened Steel
01	Karbür Düz Freze Flat Carbide Endmill	KH100S		8	○	Genel General	4	★	○	★			
02	Karbür Uzun Düz Freze Long Flat Carbide Endmill	KH100S		9	○	Genel General	4	★	○	★			
03	Karbür Küre Freze Ball Nose Carbide Endmill	KH100S		10	○	Genel General	2-4	★	○	★			
04	Karbür Uzun Küre Freze Ball Nose Long Carbide Endmill	KH100S		11	○	Genel General	2-4	★	○	★			
05	Karbür Pirr Freze Carbide Pirr Endmill	KH103S		12	○	Genel General	4	★	○	★	○	★	
06	Karbür Köşe Radyüs Freze Corner Radius Carbide Endmill	KH085U		13	○	Yüksek Hız High Speed	4	★		○		★	★
07	Karbür Köşe Radyüs Uzun Freze Corner Radius Long Carbide Endmill	KH085U		14	○	Yüksek Hız High Speed	4	★		○		★	★
08	Karbür Alüminyum Finiş Freze Carbide Aluminium Finishing Endmill	KH060S		15	□	Alüminyum Finiş Aluminum Finish	2-3				★		
09	Karbür Alüminyum Uzun Finiş Freze Long Carbide Aluminium Finishing Endmill	KH060S		16	□	Alüminyum Finiş Aluminum Finish	2-3				★		
10	Karbür Alüminyum Performans Freze Carbide Aluminium Performance Endmill	KH060S		17	□	Alüminyum Performans Aluminum Performance	3				★		
11	Karbür Alüminyum Uzun Performans Freze Long Carbide Aluminium Performance Endmill	KH060S		18	□	Alüminyum Performans Aluminum Performance	3				★		
12	Karbür Alüminyum Küre Freze Ball Nose Carbide Aluminium Endmill	KH060S		19	□	Alüminyum Aluminum	2				★		
13	Karbür Alüminyum Uzun Küre Freze Ball Nose Long Carbide Aluminium Endmill	KH060S		20	□	Alüminyum Aluminum	2				★		
14	Karbür Kaba Talaş Freze Carbide Roughing Endmill	KH103S		21	○	Genel General	4	★				○	
15	Karbür Uzun Kaba Talaş Freze Long Carbide Roughing Endmill	KH103S		22	○	Genel General	4	★				○	
16	Karbür Finiş Freze Z6 Carbide Finishing Endmill Z6	KH103S		23	○	Genel General	6	★	★			★	○
17	Karbür Uzun Finiş Freze Z6 Long Carbide Finishing Endmill Z6	KH103S		24	○	Genel General	6	★	★			★	○
22	Karbür İç Bükey Freze Carbide Rounding Concave Cutter	KH103S		25	○	Genel General	4-6-8	★	○	★	○		

Takım Kodu No Team No	Ürün Product	Çubuk Kalitesi Rod Grade	Resim Image	Sayfa Page	Kaplama Coating	Kullanım Alanı Application Area	Ağız Sayısı Number of Teeth	İş Parçası / Workpiece					
								P	M	K	N	S	H
23	Karbür T Freze Carbide T-Slovt Endmill	KH103S		26	○	Genel General		Çelik-Steel	Paslanmaz Çelik Stainless Steel	Dökme Demir Cast Iron	Demir Dışı Metal Non-ferrous Metal	Isıya Dirençli Alaşım Heat Resistant Alloy	Sertleştirilmiş Çelik Hardened Steel
25	3D Karbür Matkap 3D Carbide Drill	KH103S		27	○	Genel General		★	○	★		○	
26	5D Karbür Matkap 5D Carbide Drill	KH103S		34	○	Genel General		★	○	★		○	
27	Karbür Mikro Matkap Carbide Micro Drill	KH103S		37	○	Genel General		★	○	★		○	
28	Karbür Ekstra Uzun Matkap Extra Long Carbide Drill	KH103S		38	○	Genel General		★	○	★		○	

★ Önerilir / Recommended
○ Kullanılabilir / Acceptable

KARBÜR TAKIMLAR

SOLID CARBIDE TOOLS

01

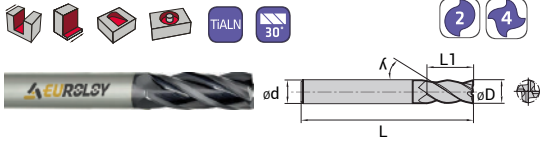
KARBÜR DÜZ FREZE
FLAT CARBIDE ENDMILLÇap:Ø3 - Ø20
Diameter:Ø3 - Ø20

Sayfa -Page: 8

02

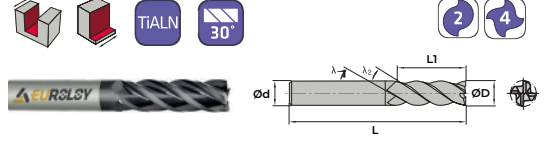
KARBÜR UZUN DÜZ FREZE
LONG FLAT CARBIDE ENDMILLÇap:Ø3 - Ø20
Diameter:Ø3 - Ø20

Sayfa -Page:9

03

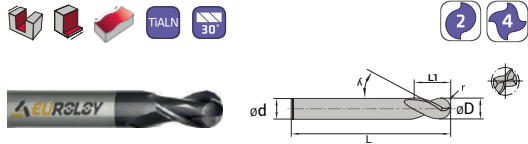
KARBÜR KÜRE FREZE
BALL NOSE CARBIDE ENDMILLÇap:Ø3 - Ø20
Diameter:Ø3 - Ø20

Sayfa -Page:10

04

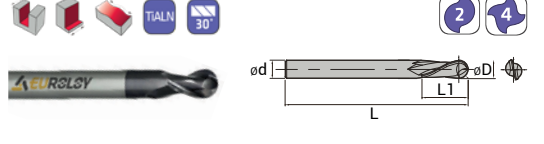
KARBÜR UZUN KÜRE FREZE
BALL NOSE LONG CARBIDE ENDMILLÇap:Ø3 - Ø20
Diameter:Ø3 - Ø20

Sayfa -Page:11

05

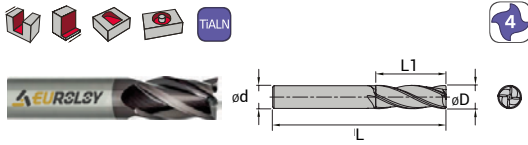
KARBÜR PİRR FREZE
CARBIDE PİRR ENDMILLÇap:Ø6 - Ø20
Diameter:Ø6 - Ø20

Sayfa -Page:12

06

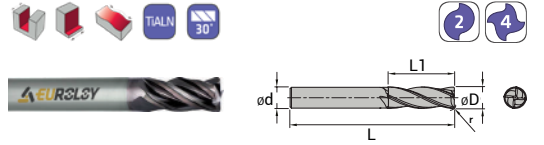
KARBÜR KÖŞE RADYUS FREZE
CORNER RADIUS CARBIDE ENDMILLÇap:Ø3 - Ø20
Diameter:Ø3 - Ø20

Sayfa -Page:13

07

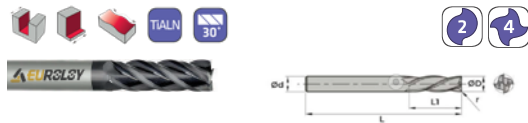
KARBÜR KÖŞE RADYUS UZUN FREZE
CORNER RADIUS LONG CARBIDE ENDMILLÇap:Ø3 - Ø20
Diameter:Ø3 - Ø20

Sayfa -Page: 14

08

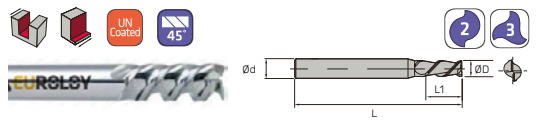
KARBÜR ALUMİNYUM FİNİŞ FREZE
CARBIDE ALUMINUM FINISHING ENDMILLÇap:Ø3 - Ø20
Diameter:Ø3 - Ø20

Sayfa -Page:15

KARBÜR TAKIMLAR

SOLID CARBIDE TOOLS

09 KARBÜR ALÜMİNYUM UZUN FİNİŞ FREZE
LONG CARBIDE ALUMINIUM FINISHING ENDMILL

Çap:Ø3 - Ø20
Diameter:Ø3 - Ø20

Sayfa -Page: 16

10 KARBÜR ALÜMİNYUM PERFORMANS FREZE
CARBIDE ALUMINIUM PERFORMANCE ENDMILL

Çap:Ø3 - Ø20
Diameter:Ø3 - Ø20

Sayfa -Page:17

11 KARBÜR ALÜMİNYUM UZUN PERFORMANS FREZE
LONG C. ALUMINIUM PERFORMANCE ENDMILL

Çap:Ø3 - Ø20
Diameter:Ø3 - Ø20

Sayfa -Page: 18

12 KARBÜR ALÜMİNYUM KÜRE FREZE
BALL NOSE CARBIDE ALUMINIUM ENDMILL

Çap:Ø3 - Ø20
Diameter:Ø3 - Ø20

Sayfa -Page:19

13 KARBÜR UZUN KABA TALAŞ FREZE
LONG CARBIDE ROUGHING ENDMILL

Çap:Ø6 - Ø25
Diameter:Ø6 - Ø25

Sayfa -Page: 20

14 KARBÜR KABA TALAŞ FREZE
CARBIDE ROUGHING ENDMILL

Çap:Ø6 - Ø28
Diameter:Ø6 - Ø28

Sayfa -Page:21

15 KARBÜR UZUN FİNİŞ FREZE Z6
LONG CARBIDE FINISHING ENDMILL Z6

Çap:Ø6 - Ø25
Diameter:Ø6 - Ø25

Sayfa -Page: 22

16 KARBÜR FİNİŞ FREZE Z6
CARBIDE FINISHING ENDMILL Z6

Çap:Ø6 - Ø28
Diameter:Ø6 - Ø28

Sayfa -Page:23

17 KARBÜR UZUN FİNİŞ FREZE Z6
LONG CARBIDE FINISHING ENDMILL Z6

Çap:Ø6 - Ø25
Diameter:Ø6 - Ø25

Sayfa -Page: 24

22 KARBÜR İÇ BÜKEY FREZE
CARBIDE ROUNDING CONCAVE CUTTER

Çap:Ø8 - Ø22
Diameter:Ø8 - Ø22

Sayfa -Page:25

KARBÜR TAKIMLAR

SOLID CARBIDE TOOLS

23

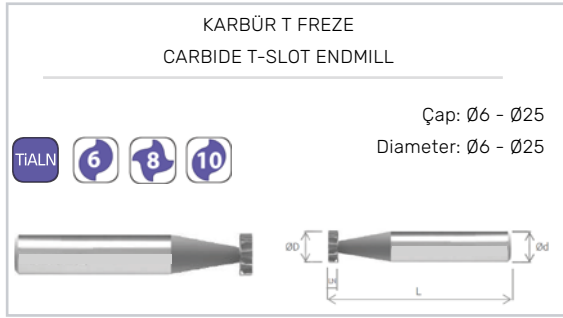

Sayfa -Page: 26

25

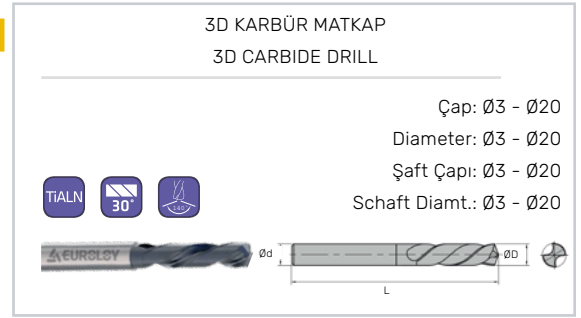

Sayfa -Page: 27

26

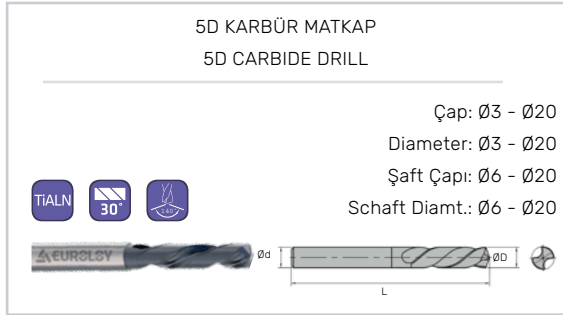

Sayfa -Page:34

27

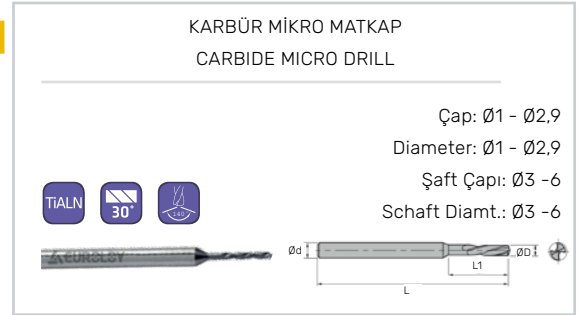

Sayfa -Page: 37

28

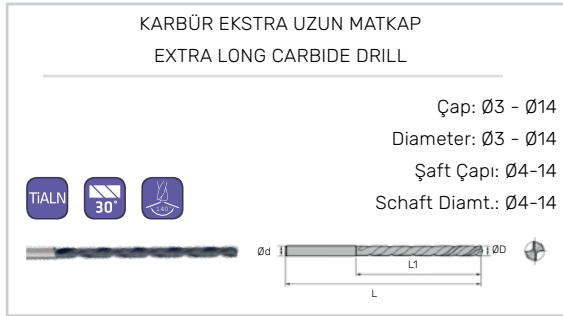

Sayfa -Page:38

01

KARBÜR DÜZ FREZE FLAT CARBIDE ENDMILL

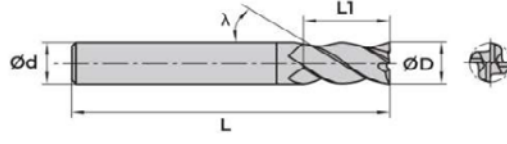

Sipariş Kodu (Z:2) Order Code	Sipariş Kodu (Z:4) Order Code	ØD(mm)	L1(mm)	L(mm)	Ød(mm)
01Z2031205003	01Z4031205003	3	12	50	3
01Z2041405104	01Z4041405104	4	14	51	4
01Z2051605105	01Z4051605105	5	16	51	5
01Z2061905806	01Z4061905806	6	19	58	6
01Z2072006407	01Z4072006407	7	20	64	7
01Z2082006408	01Z4082006408	8	20	64	8
01Z2092107309	01Z4092107309	9	21	73	9
01Z2102107310	01Z4102107310	10	21	73	10
01Z2112508411	01Z4112508411	11	25	84	11
01Z2122508412	01Z4122508412	12	25	84	12
01Z2133208413	01Z4133208413	13	32	84	13
01Z2143208414	01Z4143208414	14	32	84	14
01Z2153209315	01Z4153209315	15	32	93	15
01Z2163209316	01Z4163209316	16	32	93	16
01Z2183509318	01Z4183509318	18	35	93	18
01Z2203810020	01Z4203810020	20	38	100	20
01Z2223810022	01Z4223810022	22	38	100	22
01Z2243810024	01Z4243810024	24	38	100	24
01Z2253810025	01Z4253810025	25	38	100	25

02

KARBÜR UZUN DÜZ FREZE LONG FLAT CARBIDE ENDMILL

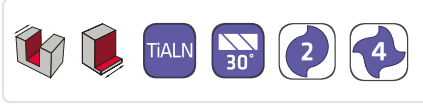
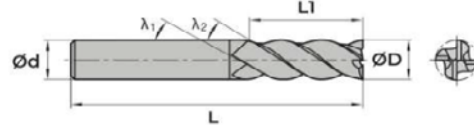

Sipariş Kodu (Z:2) Order Code	Sipariş Kodu (Z:4) Order Code	ØD(mm)	L1(mm)	L(mm)	Ød(mm)
02Z2032007503	02Z4032007503	3	20	75	3
02Z2042007504	02Z4042007504	4	20	75	4
02Z2052507505	02Z4052507505	5	25	75	5
02Z2063007506	02Z4063007506	6	30	75	6
02Z2083007508	02Z4083007508	8	30	75	8
02Z2032010003	02Z4032010003	3	20	100	3
02Z2042010004	02Z4042010004	4	20	100	4
02Z2052510005	02Z4052510005	5	25	100	5
02Z2064010006	02Z4064010006	6	40	100	6
02Z2084510008	02Z4084510008	8	45	100	8
02Z2104510010	02Z4104510010	10	45	100	10
02Z2124510012	02Z4124510012	12	45	100	12
02Z2144510014	02Z4144510014	14	45	100	14
02Z2164510016	02Z4164510016	16	45	100	16
02Z2184510018	02Z4184510018	18	45	100	18
02Z2204510020	02Z4204510020	20	45	100	20
02Z2086515008	02Z4086515008	8	65	150	8
02Z2106515010	02Z4106515010	10	65	150	10
02Z2126515012	02Z4126515012	12	65	150	12
02Z2146515014	02Z4146515014	14	65	150	14
02Z2167515016	02Z4167515016	16	75	150	16
02Z2187515018	02Z4187515018	18	75	150	18
02Z2207515020	02Z4207515020	20	75	150	20
02Z2227515022	02Z4227515022	22	75	150	22
02Z2247515024	02Z4247515024	24	75	150	24
02Z2257515025	02Z4257515025	25	75	150	25

03

KARBÜR KÜRE FREZE

BALL NOSE CARBIDE ENDMILL

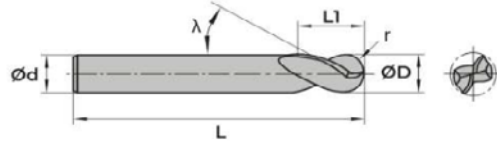

Sipariş Kodu (Z:2) Order Code	Sipariş Kodu (Z:4) Order Code	$\varnothing D$ (mm)	L_1 (mm)	L (mm)	$\varnothing d$ (mm)
03Z2031205003A	03Z4031205003A	3	12	50	3
03Z2041405104A	03Z4041405104A	4	14	51	4
03Z2051605105A	03Z4051605105A	5	16	51	5
03Z2061905806A	03Z4061905806A	6	19	58	6
03Z2072006407A	03Z4072006407A	7	20	64	7
03Z2082006408A	03Z4082006408A	8	20	64	8
03Z2092107309A	03Z4092107309A	9	21	73	9
03Z2102107310A	03Z4102107310A	10	21	73	10
03Z2112508411A	03Z4112508411A	11	25	84	11
03Z2122508412A	03Z4122508412A	12	25	84	12
03Z2132508413A	03Z4132508413A	13	32	84	13
03Z2143208414A	03Z4143208414A	14	32	84	14
03Z2163209316A	03Z4163209316A	16	32	93	16
03Z2183509318A	03Z4183509318A	18	35	93	18
03Z2203810020A	03Z4203810020A	20	38	100	20
03Z2203810022A	03Z4203810022A	22	38	100	22
03Z2403810024A	03Z4403810024A	24	38	100	24
03Z2253810025A	03Z4253810025A	25	38	100	25

04

KARBÜR UZUN KÜRE FREZE

BALL NOSE LONG CARBIDE ENDMILL

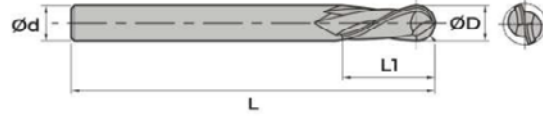

Sipariş Kodu (Z:2) Order Code	Sipariş Kodu (Z:4) Order Code	ØD(mm)	L1(mm)	L(mm)	Ød(mm)
04Z2032007503A	04Z4032007503A	3	20	75	3
04Z2042007504A	04Z4042007504A	4	20	75	4
04Z2052007505A	04Z4052007505A	5	25	75	5
04Z2063007506A	04Z4063007506A	6	30	75	6
04Z2083007508A	04Z4083007508A	8	30	75	8
04Z2032010003A	04Z4032010003A	3	20	100	3
04Z2042010004A	04Z4042010004A	4	20	100	4
04Z2052510005A	04Z4052510005A	5	25	100	5
04Z2064010006A	04Z4064010006A	6	40	100	6
04Z2084510008A	04Z4084510008A	8	45	100	8
04Z2104510010A	04Z4104510010A	10	45	100	10
04Z2124510012A	04Z4124510012A	12	45	100	12
04Z2144510014A	04Z4144510014A	14	45	100	14
04Z2164510016A	04Z4164510016A	16	45	100	16
04Z2184510018A	04Z4184510018A	18	45	100	18
04Z2204510020A	04Z4204510020A	20	45	100	20
04Z2086515008A	04Z4086515008A	8	65	150	8
04Z2106515010A	04Z4106515010A	10	65	150	10
04Z2126515012A	04Z4126515012A	12	65	150	12
04Z2146515014A	04Z4146515014A	14	65	150	14
04Z2167515016A	04Z4167515016A	16	75	150	16
04Z2187515018A	04Z4187515018A	18	75	150	18
04Z2207515020A	04Z4207515020A	20	75	150	20
04Z2227515022A	04Z4227515022A	22	75	150	22
04Z2247515024A	04Z4247515024A	24	75	150	24
04Z2257515025A	04Z4257515025A	25	75	150	25

05

KARBÜR PİRR FREZE CARBIDE PIRR ENDMILL

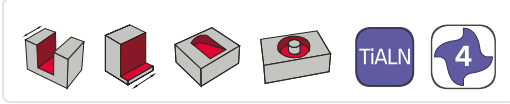
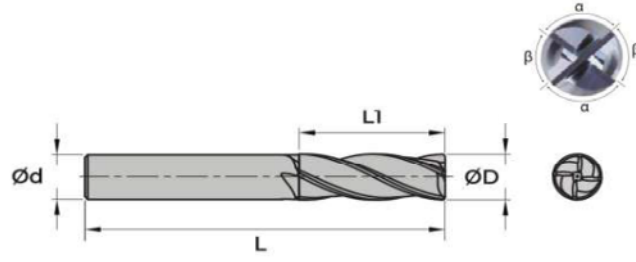

Sipariş Kodu (Z:4) Order Code	ØD(mm)	L1(mm)	L(mm)	Ød(mm)
05Z4030905806	3	9	58	6
05Z4041105806	4	11	58	6
05Z4051405806	5	14	58	6
05Z4061905806	6	19	58	6
05Z4072006407	7	20	64	7
05Z4082006408	8	20	64	8
05Z4092107309	9	21	73	9
05Z4102107310	10	21	73	10
05Z4112508411	11	25	84	11
05Z4122508412	12	25	84	12
05Z4133208413	13	32	84	13
05Z4143208414	14	32	84	14
05Z4153209315	15	32	93	16
05Z4163209316	16	32	93	16
05Z4183509318	18	35	93	18
05Z4203810020	20	38	100	20

06

KARBÜR KÖŞE RADYÜS FREZE CORNER RADIUS CARBIDE ENDMILL

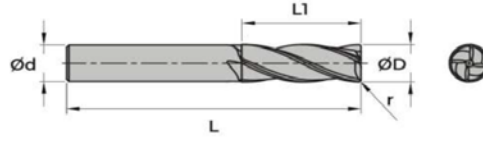

Ürün Kodu (Z:2) Order Code	Ürün Kodu (Z:4) Order Code	ØD(mm)	L1(mm)	L(mm)	Ød(mm)
06Z2031205003R#	06Z4031205003R#	3	12	50	3
06Z2041405104R#	06Z4041405104R#	4	14	51	4
06Z2051605105R#	06Z4051605105R#	5	16	51	5
06Z2061905806R#	06Z4061905806R#	6	19	58	6
06Z2072006407R#	06Z4072006407R#	7	20	64	7
06Z2082006408R#	06Z4082006408R#	8	20	64	8
06Z2092107309R#	06Z4092107309R#	9	21	73	9
06Z2102107310R#	06Z4102107310R#	10	21	73	10
06Z2112508411R#	06Z4112508411R#	11	25	84	11
06Z2122508412R#	06Z4122508412R#	12	25	84	12
06Z2133208413R#	06Z4133208413R#	13	32	84	13
06Z2143208414R#	06Z4143208414R#	14	32	84	14
06Z2153209315R#	06Z4153209315R#	15	32	93	15
06Z2163209316R#	06Z4163209316R#	16	32	93	16
06Z2183509318R#	06Z4183509318R#	18	35	93	18
06Z2203810020R#	06Z4203810020R#	20	38	100	20
06Z2223810022R#	06Z4223810022R#	22	38	100	22
06Z2243810024R#	06Z4243810024R#	24	38	100	24
06Z2253810025R#	06Z4253810025R#	25	38	100	25

07

KARBÜR KÖŞE RADYÜS UZUN FREZE

CORNER RADIUS LONG CARBIDE ENDMILL

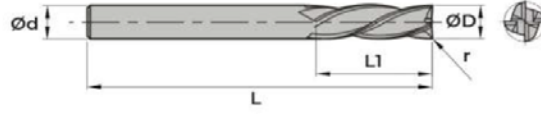

Ürün Kodu (Z:2) Order Code	Ürün Kodu (Z:4) Order Code	ØD(mm)	L1(mm)	L(mm)	Ød(mm)
07Z2032007503R#	07Z4032007503R#	3	20	75	3
07Z2042007504R#	07Z4042007504R#	4	20	75	4
07Z2052507506R#	07Z4052507506R#	5	25	75	5
07Z2063007506R#	07Z4063007506R#	6	30	75	6
07Z2083007508R#	07Z4083007508R#	8	30	75	8
07Z2032010003R#	07Z4032010003R#	3	20	100	3
07Z2042010004R#	07Z4042010004R#	4	20	100	4
07Z2052510005R#	07Z4052510005R#	5	25	100	5
07Z2064010006R#	07Z4064010006R#	6	40	100	6
07Z2084510008R#	07Z4084510008R#	8	45	100	8
07Z2104510010R#	07Z4104510010R#	10	45	100	10
07Z2124510012R#	07Z4124510012R#	12	45	100	12
07Z2144510014R#	07Z4144510014R#	14	45	100	14
07Z2164510016R#	07Z4164510016R#	16	45	100	16
07Z2184510018R#	07Z4184510018R#	18	45	100	18
07Z2204510020R#	07Z4204510020R#	20	45	100	20
07Z2086515008R#	07Z4086515008R#	8	65	150	8
07Z2106515010R#	07Z4106515010R#	10	65	150	10
07Z2126515012R#	07Z4126515012R#	12	65	150	12
07Z2146515014R#	07Z4146515014R#	14	65	150	14
07Z2167515016R#	07Z4167515016R#	16	75	150	16
07Z2187515018R#	07Z4187515018R#	18	75	150	18
07Z2207515020R#	07Z4207515020R#	20	75	150	20
07Z2227515022R#	07Z4227515022R#	22	75	150	22
07Z2247515024R#	07Z4247515024R#	24	75	150	24
07Z2257515025R#	07Z4257515025R#	25	75	150	25

08

KARBÜR ALÜMİNYUM FİNİŞ FREZE

CARBIDE ALUMINIUM FINISHING ENDMILL

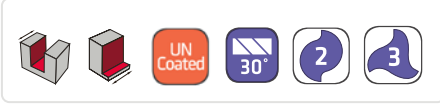

Ürün Kodu (Z:2) Order Code	Ürün Kodu (Z:3) Order Code	ØD(mm)	L1(mm)	L(mm)	Ød(mm)
08Z2031205003	08Z3031205003	3	12	50	3
08Z2041405105	08Z3041405105	4	14	51	4
08Z2051605105	08Z3051605105	5	16	51	5
08Z2061905806	08Z3061905806	6	19	58	6
08Z2072006007	08Z3072006007	7	20	60	7
08Z2082006408	08Z3082006408	8	20	64	8
08Z2092106709	08Z3092106709	9	21	67	9
08Z2102107310	08Z3102107310	10	21	73	10
08Z2112507512	08Z3112507512	11	25	75	12
08Z2122508412	08Z3122508412	12	25	84	12
08Z2133208413	08Z3133208413	13	32	84	13
08Z2143208414	08Z3143208414	14	32	84	14
08Z2153209315	08Z3153209315	15	32	93	15
08Z2163209316	08Z3163209316	16	32	93	16
08Z2183509318	08Z3183509318	18	35	93	18
08Z2203810020	08Z3203810020	20	38	100	20

09

KARBÜR ALÜMİNYUM UZUN FİNİŞ FREZE LONG CARBIDE ALUMINIUM FINISHING ENDMILL

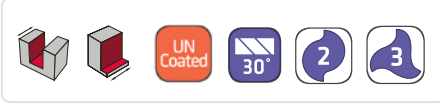
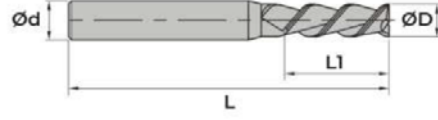

Ürün Kodu (Z:2) Order Code	Ürün Kodu (Z:3) Order Code	ØD(mm)	L1(mm)	L(mm)	Ød(mm)
09Z2032007503	09Z3032007503	3	20	75	3
09Z2042007504	09Z3042007504	4	20	75	4
09Z2052507505	09Z3052507505	5	25	75	5
09Z2063007506	09Z3063007506	6	30	75	6
09Z2083007508	09Z3083007508	8	30	75	8
09Z2032010003	09Z3032010003	3	20	100	3
09Z2042010004	09Z3042010004	4	20	100	4
09Z2052510005	09Z3052510005	5	25	100	5
09Z2063010006	09Z3063010006	6	30	100	6
09Z2083010008	09Z3083010008	8	30	100	8
09Z2104510010	09Z3104510010	10	45	100	10
09Z2124510012	09Z3124510012	12	45	100	12
09Z2144510014	09Z3144510014	14	45	100	14
09Z2164510016	09Z3164510016	16	45	100	16
09Z2184510018	09Z3184510018	18	45	100	18
09Z2204510020	09Z3204510020	20	45	100	20
09Z2086515008	09Z3086515008	8	65	150	8
09Z2106515010	09Z2106515010	10	65	150	10
09Z2126515012	09Z4126515012	12	65	150	12
09Z2146515014	09Z4146515014	14	65	150	14
09Z2167515016	09Z4167515016	16	75	150	16
09Z2187515018	09Z4187515018	18	75	150	18
09Z2207515020	09Z4207515020	20	75	150	20

10

KARBÜR ALÜMİNYUM PERFORMANS FREZE CARBIDE ALUMINIUM PERFORMANCE ENDMILL

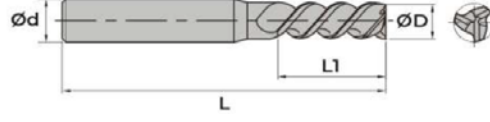

Ürün Kodu (Z:3) Order Code	ØD(mm)	L1(mm)	L(mm)	Ød(mm)
10Z3031205003	3	12	50	3
10Z3041405104	4	14	51	4
10Z3051605105	5	16	51	5
10Z3061905806	6	19	58	6
10Z3072006407	7	20	64	7
10Z3082006408	8	20	64	8
10Z3092107309	9	21	73	9
10Z3102107310	10	21	73	10
10Z3112508411	11	25	84	11
10Z3122508412	12	25	84	12
10Z3133208413	13	32	84	13
10Z3143208414	14	32	84	14
10Z3153209315	15	32	93	15
10Z3163209316	16	32	93	16
10Z3183509318	18	35	93	18
10Z3203810020	20	38	100	20

11

KARBÜR ALÜMİNYUM UZUN PERFORMANS FREZE LONG CARBIDE ALUMINIUM PERFORMANCE ENDMILL

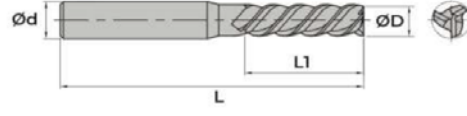

Ürün Kodu (Z:3) Order Code	ØD(mm)	L1(mm)	L(mm)	Ød(mm)
11Z3032007503	3	20	75	3
11Z3052007504	4	20	75	4
11Z3052507505	5	25	75	5
11Z3063007506	6	30	75	6
11Z3083007508	8	30	75	8
11Z3032010003	3	20	100	3
11Z3042010004	4	20	100	4
11Z3052510005	5	25	100	5
11Z3063010006	6	30	100	6
11Z3083010008	8	30	100	8
11Z3104510010	10	45	100	10
11Z3124510012	12	45	100	12
11Z3144510014	14	45	100	14
11Z3164510016	16	45	100	16
11Z3184510018	18	45	100	18
11Z3204510020	20	45	100	20
11Z3086515008	8	65	150	8
11Z3105515010	10	65	150	10
11Z3126515012	12	65	150	12
11Z3146515014	14	65	150	14
11Z3167515016	16	75	150	16
11Z3187515018	18	75	150	18
11Z3207515020	20	75	150	20

12

KARBÜR ALÜMİNYUM KÜRE FREZE BALL NOSE CARBIDE ALUMINIUM ENDMILL

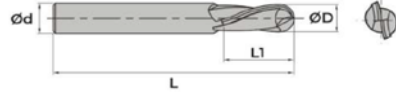

Sipariş Kodu (Z:2) Order Code	ØD(mm)	L1(mm)	L(mm)	Ød(mm)
12Z2031205003	3	12	50	3
12Z2041405104	4	14	51	4
12Z2051605105	5	16	51	5
12Z2061905806	6	19	58	6
12Z2082006408	8	20	64	8
12Z2102107310	10	21	73	10
12Z2122508412	12	25	84	12
12Z2143208414	14	32	84	14
12Z2163209316	16	32	93	16
12Z2183509318	18	35	93	18
12Z2203810020	20	38	100	20

13

KARBÜR ALÜMİNYUM UZUN KÜRE FREZE

BALL NOSE LONG CARBIDE ALUMINIUM ENDMILL

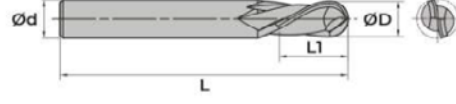

Sipariş Kodu (Z:2) Order Code	ØD(mm)	L1(mm)	L(mm)	Ød(mm)
13Z2032007503	3	20	75	3
13Z2042007504	4	20	75	4
13Z2052507505	5	25	75	5
13Z2063007506	6	30	75	6
13Z2083007508	8	30	75	8
13Z2032010003	3	20	100	3
13Z2042010004	4	20	100	4
13Z2052510005	5	25	100	5
13Z2063010006	6	30	100	6
13Z2083010008	8	30	100	8
13Z2104510010	10	45	100	10
13Z2124510012	12	45	100	12
13Z2144510014	14	45	100	14
13Z2164510016	16	45	100	16
13Z2184510018	18	45	100	18
13Z2204510020	20	45	100	20

14

KARBÜR KABA TALAŞ FREZE CARBIDE ROUGHING ENDMILL

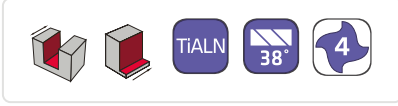
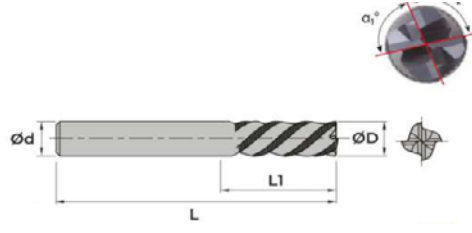

Sipariş Kodu (Z:4) Order Code	ØD(mm)	L1(mm)	L(mm)	Ød(mm)
14Z4061905706	6	19	57	6
14Z4082006308	8	20	63	8
14Z4102107210	10	21	72	10
14Z4122508312	12	25	83	12
14Z4143208314	14	32	83	14
14Z4163209216	16	32	92	16
14Z4183509218	18	35	92	18
14Z4209810020	20	38	100	20
14Z4223810022	22	38	100	22
14Z4243810024	24	38	100	24
14Z4253810025	25	38	100	25

15

KARBÜR UZUN KABA TALAŞ FREZE LONG CARBIDE ROUGHING ENDMILL



Sipariş Kodu (Z:4) Order Code	ØD(mm)	L1(mm)	L(mm)	Ød(mm)
15Z4063010006	6	30	100	6
15Z4083010008	8	30	100	8
15Z4104510010	10	45	100	10
15Z4124510012	12	45	100	12
15Z4144510014	14	45	100	14
15Z4164510016	16	45	100	16
15Z4184510018	18	45	100	18
15Z4204510020	20	45	100	20
15Z4086515008	8	65	150	8
15Z4104515010	10	65	150	10
15Z4126515012	12	65	150	12
15Z4146515014	14	65	150	14
15Z4167515016	16	75	150	16
15Z4187515018	18	75	150	18
15Z4207515020	20	75	150	20
15Z4227515022	22	75	150	22
15Z4247515024	24	75	150	24
15Z4257515025	25	75	150	25

16

KARBÜR FİNİŞ FREZE Z6

CARBIDE FINISHING ENDMILL Z6

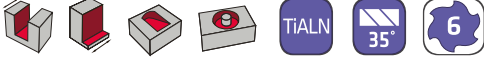
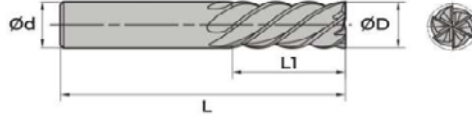

Sipariş Kodu (Z:6) Order Code	ØD(mm)	L1(mm)	L(mm)	Ød(mm)
16Z6061905806	6	19	57	6
16Z6082006408	8	20	63	8
16Z6102107310	10	21	72	10
16Z6122508412	12	25	83	12
16Z6143208414	14	32	83	14
16Z6163209316	16	32	92	16
16Z6183509318	18	35	92	18
16Z6203810020	20	38	100	20
16Z6223810022	22	38	100	22
16Z6243810024	24	38	100	24
16Z6253810025	25	38	100	25

17

KARBÜR UZUN FİNİŞ FREZE Z6

LONG CARBIDE FINISHING ENDMILL Z6

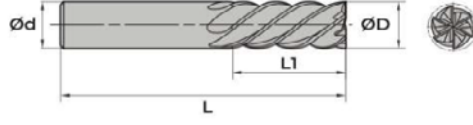

Sipariş Kodu (Z:6) Order Code	ØD(mm)	L1(mm)	L(mm)	Ød(mm)
17Z6063010006	6	30	100	6
17Z6083010008	8	30	100	8
17Z6086515008	8	65	150	8
17Z6106515010	10	65	150	10
17Z6126515012	12	65	150	12
17Z6146515014	14	65	150	14
17Z6167515016	16	75	150	16
17Z6187515018	18	75	150	18
17Z6207515020	20	75	150	20
17Z6227515022	22	75	150	22
17Z6247515024	24	75	150	24
17Z6257515025	25	75	150	25

22

KARBÜR İÇ BÜKEY FREZE

CARBIDE ROUNDING CONCAVE CUTTER

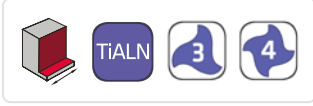
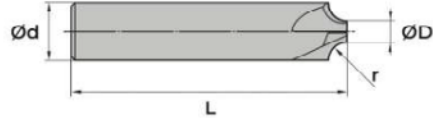

Sipariş Kodu (Z4) Order Code	r(mm)	L(mm)	Ød(mm)
22Z4061006308	1	63	8
22Z4061506709	1,5	67	9
22Z4062007210	2	72	10
22Z4062507511	2,5	75	11
22Z4063008312	3	83	12
22Z4063508313	3,5	83	13
22Z4064008314	4	83	14
22Z4064509215	4,5	92	15
22Z4065009216	5	92	16
22Z4066009218	6	92	18
22Z4068010022	8	100	22

23

KARBÜR T FREZE

CARBIDE T-SLOT ENDMILL



Sipariş Kodu Order Code	ØD (mm)	L1 (mm)	L (mm)	d(mm)
23Z60605706LN#	6	1-1,5-2	57	6
23Z60806308LN#	8	1-1,5-2-2,5-3	63	8
23Z61007210LN#	10	2-2,5-3-4-5-6	72	10
23Z81208312LN#	12	2-2,5-3-4-5-6	83	12
23Z81408314LN#	14	2-2,5-3-4-5-6	83	14
23Z81609216LN#	16	2-2,5-3-4-5-6	92	16
23Z81809218LN#	18	2-2,5-3-4-5-6	92	18
23Z82010020LN#	20	2-2,5-3-4-5-6	100	20
23Z82210022LN#	22	2-2,5-3-4-5-6	100	22
23Z82410024LN#	24	2-2,5-3-4-5-6	100	24
23Z82510025LN#	25	2-2,5-3-4-5-6	100	25

25

3D KARBÜR MATKAP

3D CARBIDE DRILL

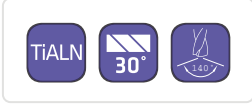
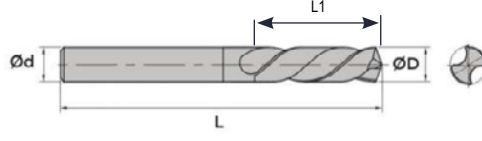

Sipariş Kodu Order Code	ØD(mm)	L1 (mm)	L(mm)	Ød(mm)
250303D04603	3,0	16	46	3
250313D05504	3,1	18	55	4
250323D05504	3,2	18	55	4
250333D05504	3,3	18	55	4
250343D05504	3,4	18	55	4
250353D05504	3,5	20	55	4
250363D05504	3,6	20	55	4
250373D05504	3,7	20	55	4
250383D05504	3,8	20	55	4
250393D05504	3,9	20	55	4
250403D06205	4,0	22	62	5
250413D06205	4,1	22	62	5
250423D06205	4,2	22	62	5
250433D06205	4,3	22	62	5
250443D06205	4,4	22	62	5
250453D06205	4,5	24	62	5
250463D06205	4,6	24	62	5
250473D06205	4,7	24	62	5
250483D06205	4,8	24	62	5
250493D06205	4,9	24	62	5
250503D06205	5,0	26	62	5
250513D06606	5,1	26	66	6
250523D06606	5,2	26	66	6
250533D06606	5,3	26	66	6
250543D06606	5,4	26	66	6
250553D06606	5,5	28	66	6

25

3D KARBÜR MATKAP

3D CARBIDE DRILL

Sipariş Kodu Order Code	ØD(mm)	L1 (mm)	L(mm)	Ød(mm)
250563D06606	5,6	28	66	6
250573D06606	5,7	28	66	6
250583D06606	5,8	28	66	6
250593D06606	5,9	28	66	6
250603D06606	6,0	28	66	6
250613D07407	6,1	31	74	7
250623D07407	6,2	31	74	7
250633D07407	6,3	31	74	7
250643D07407	6,4	31	74	7
250653D07407	6,5	31	74	7
250663D07407	6,6	31	74	7
250673D07407	6,7	31	74	7
250683D07407	6,8	31	74	7
250693D07408	6,9	34	74	8
250703D07408	7,0	34	74	8
250713D07908	7,1	34	79	8
250723D07908	7,2	34	79	8
250733D07908	7,3	34	79	8
250743D07908	7,4	34	79	8
250753D07908	7,5	34	79	8
250763D07908	7,6	37	79	8
250773D07908	7,7	37	79	8
250783D07908	7,8	37	79	8
250793D07908	7,9	37	79	8
250803D07908	8,0	37	79	8
250813D08409	8,1	37	84	9
250823D08409	8,2	37	84	9
250833D08409	8,3	37	84	9
250843D08409	8,4	37	84	9
250853D08409	8,5	37	84	9
250863D08409	8,6	40	84	9
250873D08409	8,7	40	84	9
250883D08409	8,8	40	84	9
250903D08409	8,9	40	84	9
250913D08410	9,0	40	84	10
250923D08910	9,1	40	89	10

25

3D KARBÜR MATKAP

3D CARBIDE DRILL

Sipariş Kodu Order Code	ØD(mm)	L1 (mm)	L(mm)	Ød(mm)
250933D08910	9,2	40	89	10
250943D08910	9,3	40	89	10
250953D08910	9,4	40	89	10
250963D08910	9,5	40	89	10
250963D08910	9,6	43	89	10
250973D08910	9,7	43	89	10
250983D08910	9,8	43	89	10
250993D08910	9,9	43	89	10
251003D08910	10	43	89	10
251053D09511	10,5	43	95	11
251103D09511	11	47	95	11
251153D10212	11,5	47	102	12
251203D10212	12	51	102	12
251253D10213	12,5	51	102	13
251303D10213	13	51	102	13
251353D10714	13,5	51	107	14
251403D10714	14	54	107	14
251453D11115	14,5	54	111	15
251503D11115	15	56	111	15
251553D11516	15,5	56	115	16
251603D11516	16	58	115	16
251653D11517	16,5	58	115	17
251703D11517	17	58	115	17
251753D11518	17,5	62	115	18
251803D12318	18	62	123	18
251853D12319	18,5	62	123	19
251903D12319	19	62	123	19
251953D13120	19,5	66	131	20
252003D13120	20	66	131	20

UYGULAMA ALANLARI

APPLICATIONS

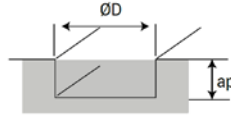
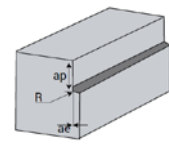
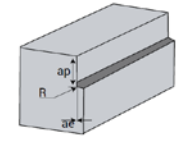
											
		ae = 1.0 x Ø			ae = 0.5 x Ø			ae = 0.1 x Ø			
		ap(mm) = 0.5 x Ø			ap(mm) = 1.0 x Ø			ap(mm) = 1.5 x Ø			
ISO	Malzeme / Material	HB	fz (mm)	Vc m/min	Vc feet/min	fz (mm)	Vc m/min	Vc feet/min	fz (mm)	Vc m/min	Vc feet/min
		HB	fz (mm)	Vc m/dak	Vc ft/dak	fz (mm)	Vc m/dak	Vc ft/dak	fz (mm)	Vc m/dak	Vc ft/dak
P	Alaşımsız Çelik Unalloyed steel	190	F0,1	145	475	F0,4	175	574	F0,6	290	951
	Düşük Alaşımlı Çelik Low-alloyed steel	240	F0,1	110	361	F0,4	135	443	F0,6	230	754
	Yüksek Alaşımlı Çelik High alloyed steel	380	F0,2	80	262	F0,5	100	328	F0,6	200	656
	Ferritik/Martensitik Paslanmaz Çelik Ferritic/martensitic stainless steel	200	F0,2	80	262	F0,5	90	295	F0,4	150	492
M	Östenitik Paslanmaz Çelik Austenitic stainless steel	200	F0,1	70	230	F0,4	80	262	F0,6	120	393
	Dupleks (Östenitik/Ferritik) Paslanmaz Çelik Duplex (austenitic/ferritic) stainless steel	260	F0,2	60	197	F0,5	70	230	F0,4	90	295
K	Dövülebilir Dökme Demir Malleable cast iron	200	F0,1	150	492	F0,4	180	590	F0,6	250	820
	Gri Dökme Demir Gray cast iron	180	F0,1	150	492	F0,4	180	590	F0,6	250	820
	Sfero Dökme Demir Nodular cast iron	215	F0,1	160	525	F0,4	190	623	F0,6	270	885
N	Alüminyum bazlı alaşımlar Aluminium based alloys	100	F0,3	680	2230	F0,3	835	2738	F0,9	950	3115
	Alüminyum bazlı alaşımlar Aluminium based alloys	75	F0,3	230	754	F0,3	305	1000	F0,9	410	1344
	Alüminyum bazlı alaşımlar Aluminium based alloys	130	F0,3	100	328	F0,3	130	426	F0,9	195	639
	Bakır ve Bakır alaşımları Copper and copper alloys	90	F0,3	130	426	F0,3	170	557	F0,9	245	803
S	Demir bazlı Süper alaşımlar Iron based superalloys	350	F0,2	25	82	F0,5	30	98	F0,7	40	131
	Nikel bazlı Süper alaşımlar Nickel based super alloys	320	F0,2	40	131	F0,5	50	164	F0,7	70	230

UYGULAMA ALANLARI

APPLICATIONS

Ağız Başı İlerleme Tablosu

Feed per Tooth Chart

Ø	2	3	4	6	8	10	12	14	16	20	25
fz(mm)	0.079	5.709	0.157	0.236	0.315	0.394	0.472	0.551	0.630	0.787	0.984
F0,1	0.012	0.016	0.021	0.029	0.037	0.046	0.054	0.062	0.071	0.087	0.108
	.0005	.0006	.0008	.0011	.0015	.0018	.0021	.0025	.0028	.0034	.0043
F0,2	0.011	0.015	0.018	0.025	0.032	0.038	0.045	0.052	0.058	0.072	0.089
	.0004	.0006	.0007	.0010	.0012	.0015	.0018	.0020	.0023	.0028	.0035
F0,3	0.027	0.033	0.040	0.053	0.066	0.079	0.092	0.105	0.118	0.145	0.177
	.0010	.0013	.0016	.0021	.0026	.0031	.0036	.0041	.0047	.0057	.0070
F0,4	0.025	0.029	0.034	0.044	0.053	0.062	0.072	0.081	0.091	0.110	0.133
	.0010	.0012	.0013	.0017	.0021	.0025	.0028	.0032	.0036	.0043	.0052
F0,5	0.023	0.027	0.030	0.037	0.044	0.051	0.058	0.065	0.072	0.086	0.104
	.0009	.0011	.0012	.0015	.0017	.0020	.0023	.0026	.0028	.0034	.0041
F0,6	0.028	0.035	0.041	0.054	0.067	0.080	0.093	0.106	0.119	0.145	0.177
	.0011	.0014	.0016	.0021	.0027	.0032	.0037	.0042	.0047	.0057	.0070
F0,7	0.025	0.031	0.036	0.047	0.057	0.068	0.079	0.089	0.100	0.121	0.148
	.0010	.0012	.0014	.0018	.0023	.0027	.0031	.0035	.0039	.0048	.0058
F0,8	0.038	0.046	0.053	0.069	0.085	0.100	0.116	0.131	0.147	0.178	0.217
	.0015	.0018	.0021	.0027	.0033	.0039	.0046	.0052	.0058	.0070	.0085

UYGULAMA ALANLARI

APPLICATIONS

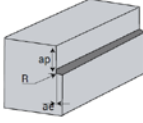
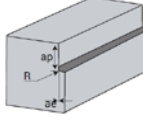
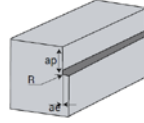
														
			PIRR ENDMILL) ap(mm) = 3.0 x Ø				PIRR ENDMILL) ap(mm) = 3.0 x Ø				PIRR ENDMILL) ap(mm) = 3.5 x Ø			
ISO	Material	HB	ae	fz (mm)	Vc m/min	Vc feet/min	ae	fz (mm)	Vc m/min	Vc feet/min	ae	fz (mm)	Vc m/min	Vc feet/min
P	Unalloyed steel	190	0.15 x Ø	F0,1	250	820	0.10 x Ø	F0,1	275	902	0.07 x Ø	F0,4	303	992
	Low-alloyed steel	240	0.15 x Ø	F0,1	240	787	0.10 x Ø	F0,2	264	866	0.07 x Ø	F0,4	290	952
	High alloyed steel	320	0.15 x Ø	F0,2	140	459	0.10 x Ø	F0,2	154	505	0.07 x Ø	F0,5	169	555
	Ferritic/martensitic stainless steel	200	0.15 x Ø	F0,2	120	393	0.10 x Ø	F0,2	132	433	0.07 x Ø	F0,5	145	476
M	Austenitic stainless steel	200	0.15 x Ø	F0,2	150	492	0.10 x Ø	F0,2	165	541	0.07 x Ø	F0,5	182	595
	Duplex (austenitic/ferritic) stainless steel	260	0.15 x Ø	F0,2	130	426	0.10 x Ø	F0,2	143	469	0.07 x Ø	F0,5	157	516
	Malleable cast iron	200	0.15 x Ø	F0,1	235	770	0.10 x Ø	F0,1	259	848	0.07 x Ø	F0,4	284	932
K	Gray cast iron	180	0.15 x Ø	F0,1	240	787	0.10 x Ø	F0,1	264	866	0.07 x Ø	F0,4	290	952
	Nodular cast iron	215	0.15 x Ø	F0,1	245	803	0.10 x Ø	F0,1	270	884	0.07 x Ø	F0,4	296	972
	Aluminium based alloys	100	0.15 x Ø	F0,4	950	3115	0.10 x Ø	F0,4	1140	3738	0.07 x Ø	F0,6	1140	3738
N	Aluminium based alloys	75	0.15 x Ø	F0,4	410	1344	0.10 x Ø	F0,4	492	1613	0.07 x Ø	F0,6	492	1613
	Aluminium based alloys	130	0.15 x Ø	F0,4	195	639	0.10 x Ø	F0,4	234	767	0.07 x Ø	F0,6	234	767
	Copper and copper alloys	90	0.15 x Ø	F0,4	245	803	0.10 x Ø	F0,4	294	964	0.07 x Ø	F0,6	294	964
S	Nickel based superalloys	350	0.05 x Ø	F0,3	55	180	0.05 x Ø	F0,3	55	180	0.05 x Ø	F0,3	55	180
	Titanium based alloys	320	0.05 x Ø	F0,3	120	393	0.05 x Ø	F0,3	120	393	0.05 x Ø	F0,3	120	393

UYGULAMA ALANLARI

APPLICATIONS

			FİNİŞ İŞLEME (FINISHING)			
			TÜM GRUPLAR (GROUPS)			
			ap(mm) = 2.0 - 4.0 x Ø			
ISO	Malzeme / Material	HB	ap (mm)	fz (mm)	Vc m/min	Vc feet/min
P	Alaşımız Çelik Unalloyed steel	190	0.10(0.05-0.2)	0.03	366	1200
	Düşük Alaşımız Çelik Low-alloyed steel	240	0.10(0.05-0.2)	0.03	351	1152
	Yüksek Alaşımız Çelik High alloyed steel	320	0.10(0.05-0.2)	0.03	205	672
	Ferritik/Martensitik Paslanmaz Çelik Ferritic/martensitic stainless steel	200	0.10(0.05-0.2)	0.03	176	576
M	Östenitik Paslanmaz Çelik Austenitic stainless steel	200	0.10(0.05-0.2)	0.03	220	720
	Dupleks (Östenitik/Ferritik) Paslanmaz Çelik Duplex (austenitic/ferritic) stainless steel	260	0.10(0.05-0.2)	0.03	190	624
	Dövülebilir Dökme Demir Malleable cast iron	200	0.10(0.05-0.2)	0.03	344	1128
K	Gri Dökme Demir Gray cast iron	180	0.10(0.05-0.2)	0.03	351	1152
	Sfero Dökme Demir Nodular cast iron	215	0.10(0.05-0.2)	0.03	359	1176
	Alüminyum bazlı alaşımlar Aluminium based alloys	100	0.10(0.05-0.2)	0.03	1140	3738
N	Alüminyum bazlı alaşımlar Aluminium based alloys	75	0.10(0.05-0.2)	0.03	492	1613
	Alüminyum bazlı alaşımlar Aluminium based alloys	130	0.10(0.05-0.2)	0.03	234	767
	Bakır ve Bakır alaşımları Copper and copper alloys	90	0.10(0.05-0.2)	0.03	294	964
S	Nikel bazlı Süper alaşımlar Nickel based superalloys	350	0.10(0.05-0.2)	0.03	50	164
	Titanyum bazlı Süper alaşımlar Titanium based alloys	320	0.10(0.05-0.2)	0.03	105	344

UYGULAMA ALANLARI

APPLICATIONS

											
		$ae = 1.0 \times \varnothing$ $ap(\text{mm}) = 0.5 \times \varnothing$			$ae = 0.5 \times \varnothing$ $ap(\text{mm}) = 1.0 \times \varnothing$			$ae = 0.1 \times \varnothing$ $ap(\text{mm}) = 1.5 \times \varnothing$			
ISO	Malzeme / Material	HB	fz (mm)	Vc m/min	Vc feet/min	fz (mm)	Vc m/min	Vc feet/min	fz (mm)	Vc m/min	Vc feet/min
		HB	fz (mm)	Vc m/dak	Vc ft/dak	fz (mm)	Vc m/dak	Vc ft/dak	fz (mm)	Vc m/dak	Vc ft/dak
N	Alüminyum Al >99% Aluminum Al >99%	30	F0,1	810	2657	F0,2	880	2887	F0,3	950	3117
	Alüminyum: Dövülmüş veya Dövülmüş ve Soğuk Şekillendirilmiş, Yaşlandırılmayan / Aluminum Wrought or wrought and coldworked, non-aging	60	F0,1	810	2657	F0,2	870	2854	F0,3	940	3084
	Alüminyum: Dövülmüş veya Dövülmüş ve Yaşlandırılmış / Aluminum Wrought or wrought and aged	100	F0,1	730	2395	F0,2	780	2559	F0,3	850	2789
	Alüminyum: Dökme, Yaşlandırılmayan Aluminum Cast, non-aging	75	F0,1	810	2657	F0,2	870	2854	F0,3	94	308
	Alüminyum: Dökme veya Dökülmüş ve Yaşlandırılmış / Aluminum Cast or cast and aged	90	F0,1	730	2395	F0,2	790	2592	F0,3	850	2789
	Alüminyum: Dökme, 13-15% Si Aluminum Cast, 13-15% Si	130	F0,1	325	1066	F0,2	350	1148	F0,3	380	1247
	Alüminyum: Dökme, 16-22% Si Aluminum Cast, 16-22% Si	130	F0,1	245	804	F0,2	265	869	F0,3	285	935
	Bakır: Otomat Alaşımlar, > 1% Pb Copper Free cutting alloys, > 1% Pb	110	F0,1	405	1329	F0,2	435	1427	F0,3	470	1542
	Bakır: Kurşunlu Bronzlar, < 1% Pb Copper Brass, leaded bronzes, < 1% Pb	90	F0,1	405	1329	F0,2	435	1427	F0,3	470	1542
Bakır: Bronz ve Kurşunsuz Bakır, Elektrolitik Bakır Copper Bronze and non-lead copper, electrolytic copper	100	F0,1	285	935	F0,2	305	1001	F0,3	330	1083	

26

5D KARBÜR MATKAP

5D CARBIDE DRILL

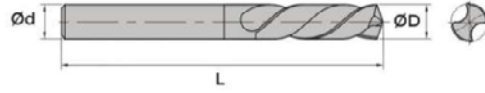

Sipariş Kodu Order Code	ØD(mm)	L1 (mm)	L(mm)	Ød(mm)
260305D06606	3,0	23	66	6
260315D06606	3,1	23	66	6
260325D06606	3,2	23	66	6
260335D06606	3,3	23	66	6
260345D06606	3,4	23	66	6
260355D06606	3,5	23	66	6
260365D06606	3,6	23	66	6
260375D06606	3,7	23	66	6
260385D06606	3,8	29	77	6
260395D06606	3,9	29	77	6
260405D07406	4,0	29	77	6
260415D07406	4,1	29	77	6
260425D07406	4,2	29	77	6
260435D07406	4,3	29	77	6
260445D07406	4,4	29	77	6
260455D07406	4,5	29	77	6
260465D07406	4,6	29	77	6
260475D07406	4,7	29	82	6
260475D08206	4,8	35	82	6
260495D08206	4,9	35	82	6
260505D08206	5,0	35	82	6
260515D08206	5,1	35	82	6
260525D08206	5,2	35	82	6
260535D08206	5,3	35	82	6
260545D08206	5,4	35	82	6
260555D08206	5,5	35	82	6

26

5D KARBÜR MATKAP

5D CARBIDE DRILL

Sipariş Kodu Order Code	ØD(mm)	L1 (mm)	L(mm)	Ød(mm)
260565D08206	5,6	35	82	6
260575D08206	5,7	35	82	6
260585D08206	5,8	35	82	6
260595D08206	5,9	35	82	6
260605D08206	6,0	35	82	6
260615D09108	6,1	43	91	8
260625D09108	6,2	43	91	8
260635D09108	6,3	43	91	8
260645D09108	6,4	43	91	8
260655D09108	6,5	43	91	8
260665D09108	6,6	43	91	8
260675D09108	6,7	43	91	8
260685D09108	6,8	43	91	8
260695D09108	6,9	43	91	8
260705D09108	7,0	43	91	8
260715D09108	7,1	43	91	8
260725D09108	7,2	43	91	8
260735D09108	7,3	43	91	8
260745D09108	7,4	43	91	8
260755D09108	7,5	43	91	8
260765D09108	7,6	43	91	8
260775D09108	7,7	43	91	8
260785D09108	7,8	43	91	8
260795D09108	7,9	43	91	8
260805D09108	8,0	43	91	8
260815D10310	8,1	49	103	10
260825D10310	8,2	49	103	10
260835D10310	8,3	49	103	10
260845D10310	8,4	49	103	10
260855D10310	8,5	49	103	10
260865D10310	8,6	49	103	10
260875D10310	8,7	49	103	10
260885D10310	8,8	49	103	10
260895D10310	8,9	49	103	10
260905D10310	9,0	49	103	10

26

5D KARBÜR MATKAP

5D CARBIDE DRILL

Sipariş Kodu Order Code	ØD(mm)	L1 (mm)	L(mm)	Ød(mm)
260915D10310	9,1	49	103	10
260925D10310	9,2	49	103	10
260935D10310	9,3	49	103	10
260945D10310	9,4	49	103	10
260955D10310	9,5	49	103	10
260965D10310	9,6	49	103	10
260975D10310	9,7	49	103	10
260985D10310	9,8	49	103	10
260995D10310	9,9	49	103	10
261005D10310	10	49	103	10
261055D11812	10,5	56	118	12
261105D11812	11,0	56	118	12
261155D11812	11,5	56	118	12
261205D11812	12,0	56	118	12
261265D12414	12,5	60	124	14
261305D12414	13,0	60	124	14
261355D12414	13,5	60	124	14
261405D12414	14,0	60	124	14
261455D13316	14,5	63	133	16
261505D13316	15,0	63	133	16
261555D13316	15,5	63	133	16
261605D13316	16,0	63	133	16
261655D14318	16,5	71	143	18
261705D14318	17,0	71	143	18
261755D14318	17,5	71	143	18
261805D14318	18,0	71	143	20
261855D15320	18,5	77	153	20
261905D15320	19,0	77	153	20
261955D15320	19,5	77	153	20
262005D15320	20,0	77	153	20

27

KARBÜR MİKRO MATKAP

CARBIDE MICRO DRILL

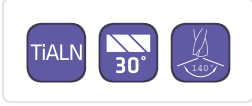
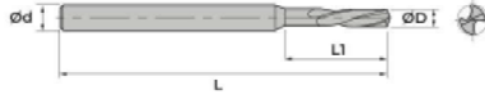

Sipariş Kodu Order Code	ØD(mm)	L1 (mm)	L(mm)	Ød(mm)
2701000805003	1	8	50	3
2701100805003	1,1	8	50	3
2701200805003	1,2	8	50	3
2701300805003	1,3	8	50	3
2701401005003	1,4	10	50	3
2701500805003	1,5	10	50	3
2701600805003	1,6	10	50	3
2701700805003	1,7	10	50	3
2701800805003	1,8	12	50	3
2701900805003	1,9	12	50	3
2702000805003	2	12	50	3
2702101205003	2,1	12	50	3
2702201205003	2,2	12	50	3
2702301405003	2,3	14	50	3
2702401405003	2,4	14	50	3
2702501405003	2,5	14	50	3
2702601405003	2,6	14	50	3
2702701405003	2,7	14	50	3
2702801405003	2,8	14	50	3
2702901405003	2,9	14	50	3

28

KARBÜR EKSTRA UZUN MATKAP

EXTRA LONG CARBIDE DRILL

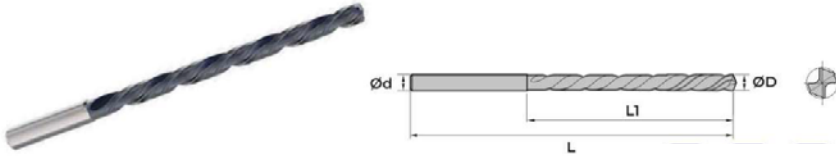

Sipariş Kodu Order Code	ØD(mm)	L1 (mm)	L (mm)	Ød(mm)
2803003306104	3	33	61	4
2803103307504	3,1	33	75	4
2803203307504	3,2	33	75	4
2803303307504	3,3	33	75	4
2803403307504	3,4	33	75	4
2803503907504	3,5	39	75	4
2803603907504	3,6	39	75	4
2803703907504	3,7	39	75	4
2803803907504	3,8	39	75	4
2803903907504	3,9	39	75	4
2804004307504	4	43	75	4
2804104308605	4,1	43	86	5
2804204308605	4,2	43	86	5
2804304308605	4,3	43	86	5
2804404308605	4,4	43	86	5
2804504708605	4,5	47	86	5
2804604708605	4,6	47	86	5
2804704708605	4,7	47	86	5
2804804708605	4,8	47	86	5
2804904708605	4,9	47	86	5
2805005208605	5	52	86	5
2805105209306	5,1	52	93	6
2805205209306	5,2	52	93	6
2805305209306	5,3	52	93	6
2805405209306	5,4	52	93	6
2805505709306	5,5	57	93	6

28

KARBÜR EKSTRA UZUN MATKAP

EXTRA LONG CARBIDE DRILL

Sipariş Kodu Order Code	ØD(mm)	L1 (mm)	L (mm)	Ød(mm)
2805605709306	5,6	57	93	6
2805705709306	5,7	57	93	6
2805805709306	5,8	57	93	6
2805905709306	5,9	57	93	6
2806005709306	6	57	93	6
2806105710907	6,1	57	109	7
2806205710907	6,2	57	109	7
2806305710907	6,3	57	109	7
2806405710907	6,4	57	109	7
2806506310907	6,5	63	109	7
2806606310907	6,6	63	109	7
2806706310907	6,7	63	109	7
2806806310907	6,8	63	109	7
2806906310907	6,9	63	109	7
2807006310907	7	63	109	7
2807106911708	7,1	69	117	8
2807206911708	7,2	69	117	8
2807306911708	7,3	69	117	8
2807406911708	7,4	69	117	8
2807506911708	7,5	69	117	8
2807606911708	7,6	69	117	8
2807706911708	7,7	69	117	8
2807806911708	7,8	69	117	8
2807906911708	7,9	69	117	8
2808007511708	8	75	117	8
2808107512509	8,1	75	125	9
2808207512509	8,2	75	125	9
2808307512509	8,3	75	125	9
2808407512509	8,4	75	125	9
2808507512509	8,5	75	125	9
2808607512509	8,6	75	125	9
2808707512509	8,7	75	125	9
2808807512509	8,8	75	125	9
2808907512509	8,9	75	125	9
2809008112509	9	81	125	9

28

KARBÜR EKSTRA UZUN MATKAP

EXTRA LONG CARBIDE DRILL

Sipariş Kodu Order Code	ØD(mm)	L1 (mm)	L (mm)	Ød(mm)
2809108113310	9,1	81	133	10
2809208113310	9,2	81	133	10
2809308113310	9,3	81	133	10
2809408113310	9,4	81	133	10
2809508113310	9,5	81	133	10
2809608113310	9,6	81	133	10
2809708113310	9,7	81	133	10
2809808113310	9,8	81	133	10
2809908113310	9,9	81	133	10
2810008713310	10	87	133	10
2810508714211	10,5	87	142	11
2811008414211	11	94	142	11
2811509415112	11,5	94	151	12
2812010115112	12	101	151	12
2812510115113	12,5	101	151	13
2813010115113	13	101	151	13
2813510115114	13,5	101	151	14
2814010115114	14	101	151	14

Engineered for Excellence.

#EuroloyExcellence



Italy Office / İtalya Ofis

 Via Leonardo Da Vinci, 4 – 20054
Milano MI ITALIA

 (+39) 0282398309

 info@euroloy.com

Turkey Office / Türkiye Ofis

 Üsküdar Cad. YEDPA No:1
Ataşehir -İstanbul -TÜRKİYE

 (+90) 850 933 3408

 euroloytr@euroloy.com