

FREZELEME MILLING

2026 | CATALOG

www.euroloy.com

 **EUROLOY**
CARBIDE TOOLS

İçindekiler

TABLE OF CONTENTS

Frezeleme Uç Kodlaması <i>Milling Insert Coding</i>	D3
Frezeleme Kaliteleri <i>Milling Grades</i>	D5
Frezeleme Uçları <i>Milling Inserts</i>	D7
Frezeleme Takımları Özet <i>Milling Tools Summary</i>	D11
Saplı Taramalar <i>Indexable Endmills</i>	D15
Freze Kafaları <i>Face Mills</i>	D33
Helisel Frezeler <i>Helical Milling Cutters</i>	D52
Vidalı Takımlar <i>Screw Type Endmills</i>	D55

S

1

Kesici Uç Şekli
Insert Shape

P

2

Ayrılma Açısı
Relief Angle

K

3

Tolerans
Tolerance

R

4

Kesici Uç Tipi
Cutting Insert Type

12

5

Kesme Kenar Uzunluğu
Cutting Edge Length

1

Kesici Uç Şekli / Insert Shape

S P K R 12 03 ED 08 S R - NN

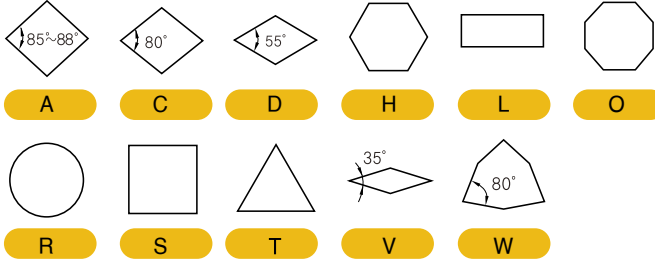

2

Ayrılma Açısı / Relief Angle

S P K R 12 03 ED 08 S R - NN

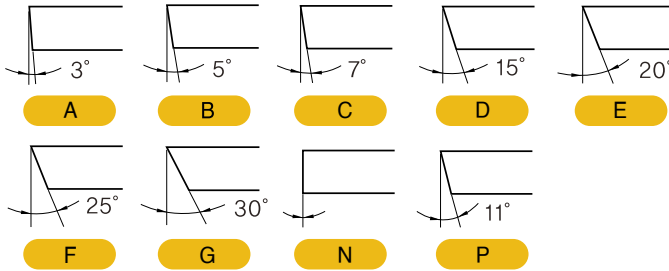

3

Tolerans / Tolerance

S P K R 12 03 ED 08 S R - NN

d: İç Teğet Çapı / inscribed circle diameter)

t: Kalınlık / thickness

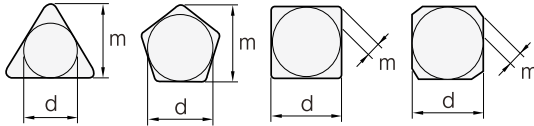
m: Resimdeki Figür
Fig. in the PictureC,E,H,M,O,P,R,S,T,W Tip Kesici Uçların Toleransları (Özel Durumlar)
Tolerance on C,E,H,M,O,P,R,S,T,W Insert Shape (Exceptional Case)
(mm)

Class Sınıf	d	m	t
A	±0.025	±0.005	±0.025
C	±0.025	±0.013	±0.025
H	±0.013	±0.013	±0.025
E	±0.025	±0.025	±0.025
G	±0.025	±0.025	±0.13
J	±0.05-±0.15	±0.005	±0.025
K	±0.05-±0.15	±0.013	±0.025
L	±0.05-±0.15	±0.025	±0.025
M	±0.05-±0.15	±0.08-±0.20	±0.13
U	±0.08-±0.25	±0.13-±0.38	±0.13

d	Tolerans d Tolerance d			Tolerans m Tolerance m		
	J,K,L,M,N	U	M,N	U		
6.35	±0.05	±0.08	±0.08	±0.13		
9.525	±0.05	±0.08	±0.08	±0.13		
12.7	±0.08	±0.13	±0.13	±0.20		
15.875	±0.10	±0.18	±0.15	±0.27		
19.05	±0.10	±0.18	±0.15	±0.27		
25.4	±0.13	±0.25	±0.18	±0.38		

D Tipi Kesici Uçların Toleransları (Özel Durumlar)
Tolerance on D Insert Shape (Exceptional Case)

d	Tolerans d Tolerance d	Tolerans m Tolerance m
6.35	±0.05	±0.11
9.525	±0.05	±0.11
12.7	±0.08	±0.15
15.875	±0.10	±0.18
19.05	±0.10	±0.18

4

Kesici Uç Tipi / Cutting Insert Type

S P K R 12 03 ED 08 S R - NN

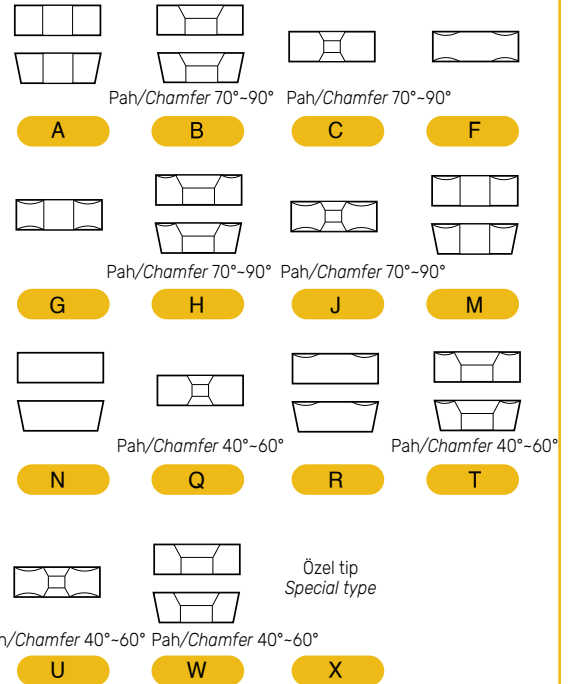

5

Kesme Kenar Uzunluğu / Cutting Edge Length

S P K R 12 03 ED 08 S R - NN

Metrik Sistem / Metric System

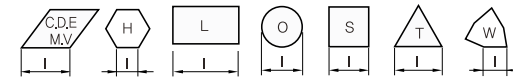
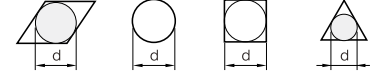
İnç Sistem
Inch System

- İç teğet çapı 1/4"ten küçük olan kesici uçlar için 1/32" değeri kullanılmalıdır.
- İç teğet çapı 1/4"ten büyük olan kesici uçlar için 1/8" değeri kullanılmalıdır.
- Use the 1/32" value for inserts with an inscribed circle (IC) smaller than 1/4".
- Use the 1/8" value for inserts with an inscribed circle (IC) of 1/4" or larger.

* Yuvarlak uçların yanı sıra
eşkenar dörtgen ve dikdörtgen
kesici uçlar daha uzun
kesme kenarı asgırlar.

"Metrik" ve "İnç" Sistemine Göre Tablo / Table According to the "Metric" and "Inch" Systems

Metrik ve İnç Ölçü Sistemleri Tablosu / Table According to The "Metric" and "Inch" Systems								
	6	9	11	16	22	27	33	44
	3	5	6	9	12	15	19	25
	4	6	7	11	15	19	23	31
	3	5	6	9	12	16	19	25
İç Teğet Çember Çapı Internal tangent diameter	5/32"	7/32"	1/4"	3/8"	1/2"	5/8"	3/4"	1"
İnç Sistemi Inch System	5	7	2 (8)	3	4	5	6	8

03

ED
08

S

R

NN

6

Kesici Uç Kalınlığı
Height of Cutting Edge

7

Köşe Radyüsü
Nose Radius (Nose R)

8

Kenar Şekli
Edge Shape

9

Kesme Yönü
Cutting Direction

10

Frezeleme için Talaş Kırıcı
Chip Breaker for Milling

6 Kesici Uç Kalınlığı / Height of Cutting Edge

S P K R 12 03 ED 08 S R - NN

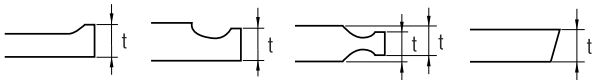

Sembol / Symbol		Kesici Kenar Kalınlığı (t) Cutting edge thickness (t)	
Metrik / Metric	İnç / Inch	mm	İnç / Inch
01	1 (2)	1.59	1/16
T0	1.125	1.79	9/128
T1	1.2	1.98	5/64
02	1.5 (3)	2.38	3/32
T2	1.75	2.78	7/64
03	2	3.18	1/8
T3	2.5	3.97	5/32
04	3	4.76	3/16
05	3.5	5.56	7/32
06	4	6.35	1/4
07	5	7.94	5/16
09	6	9.52	3/8
11	7	11.11	7/16
12	8 (16)	12.70	1/2

Küçük ölçülü kesici uçlar için semboller
symbols for small size inserts

7 Köşe Radyüsü / Nose Radius

S P K R 12 03 ED 08 S R - NN

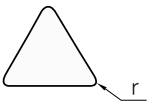

r		Sembol / Symbol		r		Sembol / Symbol	
mm	Inch	mm	Inch	mm	Inch	mm	Inch
00	0	0.0		12	3	1.2	3/64
02		0.2		15		1.5	
04	1	0.4	1/64	16	4	1.6	4/64
05		0.5		24	6	2.4	6/64
08	2	0.8	2/64	32	8	3.2	8/64
10		1.0		40		4.0	

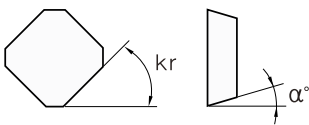

Paralel Yüzey / Parallel surface kr	Boşluk Açısı / Relief Angle a°
A - 45°	A - 3° F - 25°
D - 60°	B - 5° G - 30°
E - 75°	C - 7° N - 0°
F - 85°	D - 15° P - 11°
P - 90°	
Z - Special	

8 Kenar Şekli / Edge Shape

S P K R 12 03 ED 08 S R - NN

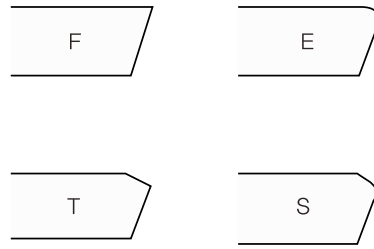

9 Kesme Yönü / Cutting Direction

S P K R 12 03 ED 08 S R - NN

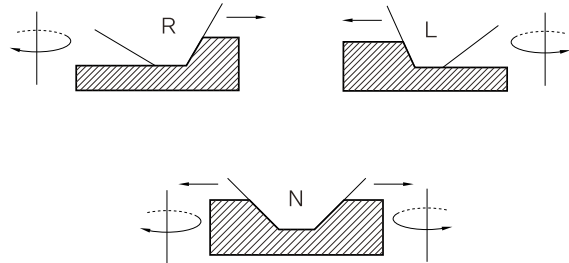

10 Frezeleme için Talaş Kırıcı / Chip Breaker for Milling

S P K R 12 03 ED 08 S R - NN



M AL NN HM90



F57 M2 H2 GM



AL EN PM1 GH

FREZELEME KALİTELERİ / MILLING GRADES

Kalite Grade	ISO	Kaplama Coating	Stok Durumu Stock Availability	Özellikler Features
TC0135	P35	CVD	△	<p>Çeliğin yüksek hızda frezelenmesi için CVD kaplamalı kalite. İyi aşınma direnci ve tokluğu bir araya getirerek talaşlanma ve kenar kırılmasını önler. Hem ıslak hem de kuru koşullarda kullanılabilir.</p> <p><i>CVD coated grade for high speed milling of steel. It combines good wear resistance and toughness to avoid chipping and edge breakage. Can be used in both wet and dry conditions.</i></p>
TC0140	P40	CVD	△	<p>Darbeli kesme koşullarında büyük kesme derinliğinde, orta ve yüksek hızda çelik frezeleme için uygundur.</p> <p><i>Suitable for big cutting depth, medium to high speed milling of steel under unstable cutting conditions.</i></p>
TC2215	K15	CVD	●	<p>Dökme demirin yüksek hızlı frezelenmesi için CVD kaplamalı kalite. Daha yüksek kesme parametreleri için uygundur ve istikrarlı performans ve güvenilirlik sağlar. Finiş, yarı finiş ve kaba frezelemede kullanılabilir.</p> <p><i>CVD coated grade for high speed milling of cast iron. Suitable for higher cutting parameters and ensures stable performance and reliability. Can be used from finish, semi-finish to rough milling.</i></p>
TC2225	K25	CVD	○	<p>Orta ve yüksek kesme hızlarında gri dökme demirin yarı finişaj ve kaba frezeleme işlemleri için uygundur. Daha uzun takım ömrü elde etmek için kuru kesme koşullarında kullanılması önerilir.</p> <p><i>Suitable for semi-finish milling and rough milling of gray cast iron at medium and high cutting speed. Recommended for dry cutting conditions to achieve longer tool life.</i></p>
TP2125	P25 M25	PVD	●	<p>Çelik frezeleme için ilk tercihtir. Stabil çalışma koşullarında çeliğin kaba ve finiş işlemlerinde kullanılması önerilir. Küçük kesme genişliği ve yapışkan malzemelerde hem kuru hem de ıslak işleme için uygundur.</p> <p><i>First choice for steel milling. It is recommended to be used in rough to finish machining of steel under stable working conditions, good for both dry and wet machining with small cutting width, complex tool path and sticky materials.</i></p>
TP2135	P35 M35	PVD	○	<p>Yüksek tokluk gerektiğinde orta sertlikteki alt tabaka ile TP2125'e alternatif kalite.</p> <p><i>Supplementary grade to TP2125 with medium hardness substrate when high toughness is required.</i></p>
TP2335	M35	PVD	○	<p>Darbeli işleme koşullarında orta ve düşük hızda paslanmaz çelik ve çeliğin frezelenmesi için uygundur.</p> <p><i>Suitable for milling stainless steel and steel at medium and low speed under unstable machining conditions.</i></p>
TP2345	P35 M35	PVD	○	<p>Ultra kalın PVD kaplamalı kalite, paslanmaz çelik frezeleme için ilk tercihtir. Darbeli işleme koşullarında paslanmaz çeliğin kaba frezelenmesi için uygundur.</p> <p><i>Ultra-thick PVD coated grade is the first choice for stainless steel milling. It is suitable for rough milling of stainless steel under unstable machining conditions.</i></p>
TP2225	K25	PVD	○	<p>Orta ve düşük kesme hızlarında gri dökme demir ve sfero dökme demirin yarı finiş ve kaba frezelemesi için uygundur. Hem kuru hem de ıslak koşullarda mükemmel takım ömrüne sahiptir.</p> <p><i>Suitable for semi-finish and rough milling of gray cast iron and nodular cast iron at medium and low cutting speed. Has excellent tool life under both dry and wet conditions.</i></p>

● Stok ürün - Stock item

○ Stok dışı ürün - Non Stock item

△ Özel Sipariş - Special order

FREZELEME KALİTELERİ / MILLING GRADES

Kalite Grade	ISO	Kaplama Coating	Stok Durumu Stock Availability	Özellikler Features
TP4415	S15	PVD	●	<p>Karbür alt tabaka hem tokluk hem de kırmızı sertlik özelliklerine sahiptir ve dengesiz işleme koşullarında paslanmaz çeliğin kaba frezelenmesinde kullanılır. Düşük kesme hızında kullanılması önerilir.</p> <p><i>Carbide substrate has both toughness and red hardness characteristics and is suitable for rough milling of stainless steel under unstable machining conditions. Milling at low cutting speed can achieve longer tool life.</i></p>
TP4405	H15	PVD	△	<p>Siparişe üstüne üretilen bu kalite, sertleştirilmiş çeliğin frezelenmesine uygundur. Kaba ve finiş frezelemede kullanılabilir ve çoğu operasyonda ihtiyaçlarınızı karşılar.</p> <p><i>Produced-per-order grade, suitable for milling hardened steel. Can be used in rough and finish milling, meeting the needs of most conditions.</i></p>
TP2620	P20 M20 K20 S15 H15	PVD	●	<p>Mükemmel aşınma direnci ve stabilizeye sahip üniversal kalite. Çelik, paslanmaz çelik ve dökme demirin frezelenmesi için uygundur. Ayrıca süper alaşımların ve HRC45-55 sertleştirilmiş malzemelerin yarı finiş frezelenmesi için de uygundur.</p> <p><i>Universal grade with excellent wear resistance and stability. Suitable for milling of steel, stainless steel and cast iron. Also applicable for semi-finishing of superalloys and semi-finish milling of HRC45-55 hardened materials.</i></p>
TP2630 TP4630	P30 M30 K40 S25 H25	PVD	●	<p>Çelik ve paslanmaz çeliğin kaba, yarı finisaj ve hafif kesintili frezeleme işlemleri için uygun üniversal kalite.</p> <p><i>Universal grade applicable for rough, semi-finish and light interrupted milling of steel and stainless steel</i></p>
TP2640	P45 M45 K45 S25 H25	PVD	△	<p>Yüksek tokluk gerektiğinde TP2630'a ek kalite.</p> <p><i>Supplementary grade to TP2630 when high toughness is required.</i></p>
TP2320 TP1320	P20 M20	PVD	●	<p>Mükemmel aşınma direnci ve tokluğa sahip, paslanmaz çeliğin frezelenmesinde ilk tercihtir. Ayrıca çeliğin genel işlenmesinde de iyi sonuç verir.</p> <p><i>Submicron grade with excellent wear resistance and toughness, first choice for continuous milling of stainless steel. Also works well for general machining of steel.</i></p>
TN7501	N15	-	●	<p>Alüminyum alaşımlarının frezelenmesinde kullanılan, keskin kesici kenarlı, kaplamasız kalite.</p> <p><i>Uncoated grade combined with sharp cutting edge, used in aluminum alloy milling.</i></p>

● Stok ürün - Stock item













































○ Stok dışı ürün - Non Stock item

△ Özel Sipariş - Special order

FREZELEME TAKIMLARI ÖZET / MILLING TOOLS SUMMARY

Tip Type	Ürün Görsele Product Picture	Kod Code	Yanaşma Açısı Approach Angle	Çap Aralığı Diameter Range	Bağlanılan Uç Insert	Özellikler Feature	Takım Sayfası Page
SAPLI TARAMALAR INDEXABLE ENDMILLS		MSG...	90°	Ø12-40 mm	APKT 10...		D15
		MSZ...	90°	Ø16-32 mm	APKT 11T3...		D18
		MSZ...	90°	Ø25-33 mm	APKT 16...		D19
		MST...	90°	Ø20-32 mm	3PKT 10...		D19
		MSW...	-	Ø 8-32 mm	RCE...		D20
		MSY...	90°	Ø16-33 mm	LNGX 03...		D21
		MSK...	90°	Ø16-40 mm	LNMX 10...		D22
		MSG...	90°	Ø35-50 mm	TPKN 16...		D22
		MSG...	-	Ø16-40 mm	RD... 0803 RD... 1003 RD... 10T3 RD... 1204		D23
		MSG...	45°-60°	Ø15-40 mm	TCMT 11... TCMT 16...		D24
		MSK...	14°	Ø25-32 mm	WNGX 09...		D24
		MSS...	90°	Ø16-25 mm	R390 11...		D25
		MSE...	90°	Ø25-40 mm	APKT 17...		D25
		MST...	90°	Ø16-26 mm	SNKT 06...		D26
		MST...	90°	Ø25-32 mm	6NGU 06...		D26
		MST...	90°	Ø32 mm	3PKT 15...		D27
		MSY...	90°	Ø10-16 mm	LPGU 0102...		D27
		MSZ...	10°	Ø22-42 mm	SDMT 09...		D28
		MSE...	90°	Ø40 mm	LNHU 13...		D28
		MSE...	90°	Ø20-33 mm	LNHU 09...		D29
	MSE...	45°	Ø40 mm	XNMU 07...		D29	
	MSE...	15°	Ø25-32 mm	SDMT 09...		D30	

Tip Type	Ürün Görseli Product Picture	Kod Code	Yanaşma Açısı Approach Angle	Çap Aralığı Diameter Range	Bağlanılan Uç Insert	Özellikler Feature	Takım Sayfası Page
SAPLI TARAMALAR INDEXABLE ENDMILLS		MSE...	15°	Ø25-32 mm	SDMT 09...		D30
		MSE...	15°	Ø32 mm	SDMT 12...		D30
		MSE...	-	Ø15-22 mm	RPHX 10T...		D31
		MSE...	-	Ø32 mm	RPHX 12...		D31
		MSK...	90°	Ø20-40 mm	XEKT 19...		D32
		MSK...	14°	Ø25-32 mm	WNGX 09T3...		D32
FREZE KAFALARI MILLING HEADS		MCG...	90°	Ø40-100 mm	APKT 10...		D33
		MCY...	90°	Ø40-52 mm	LNGX 03...		D33
		MCG...	90°	Ø40-80 mm	APKT 11... APKT 16...		D34
		MCK...	90°	Ø40-50 mm	LNMX 1006...		D34
		MCK...	90°	Ø50-160 mm	LNMX 1510...		D34
		MCG...	-	Ø40-160 mm	RD... 1003... RD... 10T3... RD... 12T3... RD... 1604...		D35
		MCK...	45°	Ø50-160 mm	SNMX 1205...		D36
		MCK...	88°	Ø50-250 mm	SNMX 1206... SNMX1205...		D36
		MCG...	90°	Ø50-100 mm	TPKN 16...		D37
		MCG...	90°	Ø63-250 mm	TPKN 22...		D37
		MCK...	14°	Ø40-66 mm	WNGX 09T3...		D37
		MCY...	90°	Ø50-250 mm	WNMU 0806...		D38
		MCT...	90°	Ø50-100 mm	3PKT 15...		D39
		MCT...	90°	Ø40-63 mm	3PKT 10...		D39
		MCT...	90°	Ø40-63 mm	6NGU 06...		D39
		MCT...	90°	Ø50-125 mm	6NGU 09...		D39

Tip Type	Ürün Görseli Product Picture	Kod Code	Yanaşma Açısı Approach Angle	Çap Aralığı Diameter Range	Bağlanılan Uç Insert	Özellikler Feature	Takım Sayfası Page
FREZE KAFALARI MILLING HEADS		MCS...	90°	Ø40-63 mm	R390 11...		D40
		MCZ...	10°	Ø40-100 mm	SDMT 09...		D40
		MCW ...	90°	Ø50-63 mm	SPMT 12...		D41
		MCG...	75°	Ø63-200 mm	SPKN 12...		D41
		MCZ...	45°	Ø50-160 mm	ONHU 08...		D42
		MCE...	40°	Ø50-160 mm	ODMT 06...		D43
		MCE...	90°	Ø50-100 mm	APKT 17...		D43
		MCE...	45°	Ø40-200 mm	XNMT 07...		D44
		MCE...	45°	Ø63-315 mm	XNMT 09...		D44
		MCE...	90°	Ø40-80 mm	LNHT 09...		D45
		MCE...	90°	Ø63-160 mm	LNHT 16...		D45
		MCE...	90°	Ø40-250 mm	LNHT 13...		D46
		MCE...	15°	Ø40-50 mm	SDMT 09...		D47
		MCE...	15°	Ø52-125 mm	SDMT 12...		D47
		MCE...	-	Ø30-40 mm	RPHX 10T...		D48
		MCE...	-	Ø40-80 mm	RPHX 12...		D48
		MCE...	-	Ø63-100 mm	RPHX 16...		D49
		MCE...	45°	Ø63-160 mm	HNGX 09...		D49
		MCK...	90°	Ø40-125 mm	XEKT 19...		D50
		MCZ...	45°	Ø63-125 mm	ONHU 06...		D50
		MCE...	90°	Ø40-50 mm	LNHT 09...		D51
		MCE...	90°	Ø25-40 mm	LNHT 09...		D51

Tip Type	Ürün Görseli Product Picture	Kod Code	Yanaşma Açısı Approach Angle	Çap Aralığı Diameter Range	Bağlanılan Uç Insert	Özellikler Feature	Takım Sayfası Page
HELİSEL FREZELER HELICAL MILLING CUTTERS		MTE...	90°	Ø25-32 mm	LNHU 09...		D51
		MCE...	90°	Ø40-80 mm	LNHU 13...		D52
		MSE...	90°	Ø40 mm	LNHU 13...		D52
		MSG...	90°	Ø40-80 mm	APKT 10...		D52
		MTY...	90°	Ø20-42 mm	LNGX 03...		D54
		MTK...	14°	Ø25-40 mm	WNGX 09T3...		D54
VİDALI TAKIMLAR SCREW TOOLS		MTK...	14°	Ø16-35 mm	WNGX 0603...		D55
		MTK...	90°	Ø25-40 mm	XEKT 19...		D55
		MTG...	90°	Ø16-40 mm	APKT 10...		D56
		MTG...	90°	Ø25-40 mm	APKT 16...		D56
		MTT...	90°	Ø32-42 mm	3PKT 10...		D56
		MTT...	90°	Ø21-32 mm	SNKT 06...		D57
		MTZ...	15°	Ø25-42 mm	SDMT 09...		D57
		MTE...	-	Ø15-22 mm	RPHX 10T...		D58
		MTE...	-	Ø40mm	RPHX 12...		D58

SAPLI TARAMALAR / INDEXABLE ENDMILLS

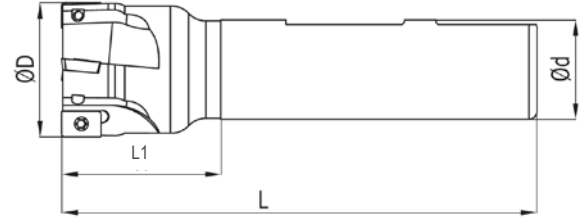

90°



Takım Kodu Order Code	Stok Durumu Stock Availability	D (mm)		L1 (mm)	L (mm)	d (mm)	Uç Insert	Vida Screw	Anahtar Torx Key
MSG012-01-AP10-120	●	12	1	40	120	12	APKT1003...	SM2,5X6	T08
MSG012-01-AP10-120-C	●	12	1	40	120	12			
MSG014-01-AP10-120	●	14	1	30	120	12			
MSG016-02-AP10-100	●	16	2	35	100	16			
MSG016-02-AP10-100-C	●	16	2	35	100	16			
MSG016-02-AP10-120	●	16	2	40	120	16			
MSG016-02-AP10-120-C	●	16	2	40	120	16			
MSG016-02-AP10-150	●	16	2	50	150	16			
MSG016-02-AP10-150-C	●	16	2	50	150	16			
MSG016-02-AP10-200	●	16	2	50	200	16			
MSG016-02-AP10-200-C	●	16	2	50	200	16			
MSG016-02-AP10-250	●	16	2	60	250	16			
MSG018-02-AP10-100	●	18	2	30	100	16			
MSG018-02-AP10-100-C	●	18	2	30	100	16			
MSG018-02-AP10-120	●	18	2	30	120	16			
MSG018-02-AP10-120-C	●	18	2	30	120	16			
MSG018-02-AP10-150	●	18	2	30	150	16			
MSG018-02-AP10-150-C	●	18	2	30	150	16			
MSG018-02-AP10-200	●	18	2	30	200	16			
MSG018-02-AP10-200-C	●	18	2	30	200	16			
MSG020-03-AP10-100	●	20	3	30	100	20	APKT1003...	SM2,5X7	T08
MSG020-03-AP10-100-C	●	20	3	30	100	20			
MSG020-03-AP10-120	●	20	3	40	120	20			
MSG020-03-AP10-120-C	●	20	3	40	120	20			
MSG020-03-AP10-150	●	20	3	50	150	20			
MSG020-03-AP10-150-C	●	20	3	50	150	20			
MSG020-03-AP10-200	●	20	3	60	200	20			
MSG020-03-AP10-200-C	●	20	3	60	200	20			

● Stok ürün - Stock item

○ Stok dışı ürün - Non Stock item

△ Özel Sipariş - Special order

SAPLI TARAMALAR / INDEXABLE ENDMILLS

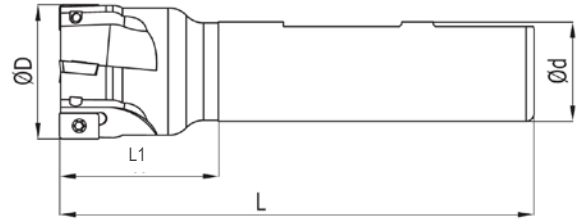

90°



Takım Kodu Order Code	Stok Durumu Stock Availability	D (mm)		L1 (mm)	L (mm)	d (mm)	Uç Insert	Vida Screw	Anahtar Torx Key
MSG020-03-AP10-200-C	●	20	3	60	200	20			
MSG020-03-AP10-250	●	20	3	60	250	20			
MSG022-03-AP10-100	●	22	3	30	100	20			
MSG022-03-AP10-100-C	●	22	3	30	100	20			
MSG022-03-AP10-120	●	22	3	30	120	20			
MSG022-03-AP10-120-C	●	22	3	30	120	20	APKT1003...	SM2,5X7	T08
MSG022-03-AP10-150	●	22	3	30	150	20			
MSG022-03-AP10-150-C	●	22	3	30	150	20			
MSG022-03-AP10-200	●	22	3	30	200	20			
MSG022-03-AP10-250	●	22	3	30	250	20			
MSG025-03-AP10-100	●	25	3	35	100	25			
MSG025-03-AP10-100-C	●	25	3	35	100	25			
MSG025-03-AP10-120	●	25	3	40	120	25			
MSG025-03-AP10-120-C	●	25	3	40	120	25			
MSG025-03-AP10-150	●	25	3	50	150	25			
MSG025-03-AP10-150-C	●	25	3	50	150	25			
MSG025-03-AP10-200	●	25	3	60	200	25			
MSG025-03-AP10-200-C	●	25	3	60	200	25			
MSG025-03-AP10-250	●	25	3	60	250	25			
MSG026-03-AP10-150	●	26	3	30	150	25	APKT1003...	SM2,5X7	T08
MSG026-03-AP10-200	●	26	3	30	200	25			
MSG026-03-AP10-250	●	26	3	30	250	25			
MSG028-04-AP10-150	●	28	4	30	150	25			
MSG028-04-AP10-150-C	●	28	4	30	150	25			
MSG030-04-AP10-100	●	30	4	30	100	25			
MSG030-04-AP10-100-C	●	30	4	30	100	25			
MSG030-04-AP10-120	●	30	4	30	120	25			
MSG030-04-AP10-120-C	●	30	4	30	120	25			

● Stok ürün - Stock item

○ Stok dışı ürün - Non Stock item

△ Özel Sipariş - Special order

SAPLI TARAMALAR / INDEXABLE ENDMILLS

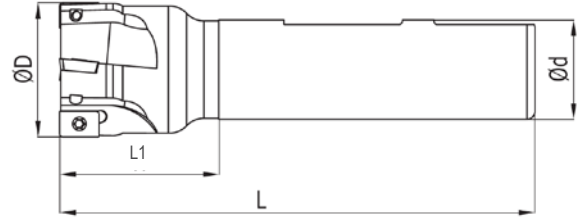

90°

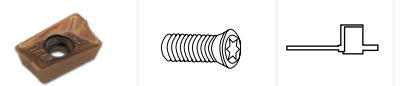

Takım Kodu Order Code	Stok Durumu Stock Availability	D (mm)		L1 (mm)	L (mm)	d (mm)	Uç Insert	Vida Screw	Anahtar Torx Key
MSG030-04-AP10-120-C	●	30	4	30	120	25	APKT1003...	SM2,5X7	T08
MSG030-04-AP10-150	●	30	4	40	150	25			
MSG030-04-AP10-150-C	●	30	4	40	150	25			
MSG030-04-AP10-200	●	30	4	40	200	25			
MSG030-04-AP10-200-C	●	30	4	40	200	25			
MSG030-04-AP10-300	●	30	4	40	300	25			
MSG032-04-AP10-150	●	32	4	40	150	25			
MSG032-04-AP10-150-C	●	32	4	60	150	32			
MSG032-04-AP10-200	●	32	4	60	200	32			
MSG032-04-AP10-200-C	●	32	4	60	200	32			
MSG035-04-AP10-100	●	35	4	30	100	32			
MSG035-04-AP10-100-C	●	35	4	30	100	32			
MSG035-04-AP10-120	●	35	4	30	120	32			
MSG035-04-AP10-120-C	●	35	4	30	120	32			
MSG035-04-AP10-150	●	35	4	30	150	32			
MSG035-04-AP10-150-C	●	35	4	30	150	32			
MSG035-04-AP10-200	●	35	4	30	200	32			
MSG040-04-AP10-100	●	40	4	40	100	32			
MSG040-05-AP10-100-C	●	40	5	40	100	32			
MSG040-05-AP10-120	●	40	5	40	120	32			
MSG040-05-AP10-120-C	●	40	5	40	120	32			
MSG040-05-AP10-150	●	40	5	40	150	32			
MSG040-05-AP10-150-C	●	40	5	40	150	32			

● Stok ürün - Stock item

○ Stok dışı ürün - Non Stock item

△ Özel Sipariş - Special order

SAPLI TARAMALAR / INDEXABLE ENDMILLS

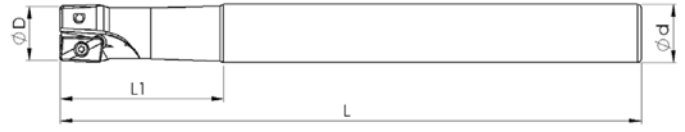

90°



Takım Kodu Order Code	Stok Durumu Stock Availability	D (mm)		L1 (mm)	L (mm)	d (mm)	Uç Insert	Vida Screw	Anahtar Torx Key
MSZ016-02-AP11-100	●	16	2	30	100	16	APKT11T3...	SM2,5X6	T08
MSZ016-02-AP11-160	●	16	2	30	160	16			
MSZ016-02-AP11-160-C	●	16	2	30	160	16			
MSZ016-02-AP11-200	●	16	2	30	200	16			
MSZ016-02-AP11-200-C	●	16	2	30	200	16			
MSZ017-02-AP11-160	●	17	2	30	160	16			
MSZ017-02-AP11-200	●	17	2	30	200	16			
MSZ017-02-AP11-250	●	17	2	30	250	16			
MSZ018-02-AP11-160	●	18	2	30	160	16			
MSZ020-03-AP11-120	●	20	3	30	120	20			
MSZ020-03-AP11-160	●	20	3	30	160	20			
MSZ020-03-AP11-160-C	●	20	3	40	160	20			
MSZ020-03-AP11-200	●	20	3	40	200	20			
MSZ021-03-AP11-160	●	21	3	40	160	20			
MSZ021-03-AP11-200	●	21	3	40	200	20			
MSZ022-03-AP11-250	●	22	3	40	250	20			
MSZ025-03-AP11-120	●	25	3	40	120	25			
MSZ025-03-AP11-160	●	25	3	40	160	25			
MSZ025-03-AP11-200	●	25	3	40	200	25			
MSZ026-03-AP11-160	●	26	3	50	160	25			
MSZ026-03-AP11-200	●	26	3	30	200	25			
MSZ026-03-AP11-250	●	26	3	40	250	25			
MSZ032-04-AP11-200	●	32	4	50	200	32			

SAPLI TARAMALAR / INDEXABLE ENDMILLS

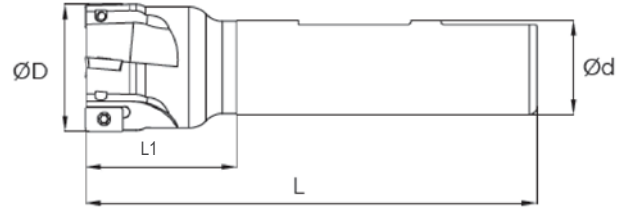
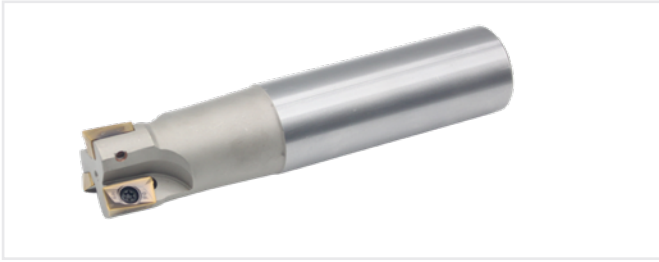

90°



Takım Kodu Order Code	Stok Durumu Stock Availability	D (mm)		L1 (mm)	L (mm)	d (mm)	Uç Insert	Vida Screw	Anahtar Torx Key
MSZ025-02-AP16-170	●	25	2	50	170	25	APKT1604...	SM4X9	T15
MSZ026-02-AP16-200	●	26	2	30	200	25			
MSZ026-02-AP16-250	●	26	2	30	250	25			
MSZ032-03-AP16-170	●	32	3	50	170	32			
MSZ033-03-AP16-200	●	33	3	40	200	32			
MSZ033-03-AP16-250	●	33	3	40	250	32			
MSZ033-03-AP16-300	●	33	3	40	300	32			
MSZ033-03-AP16-350	●	33	3	40	350	32			
MSZ033-03-AP16-400	●	33	3	40	400	32			

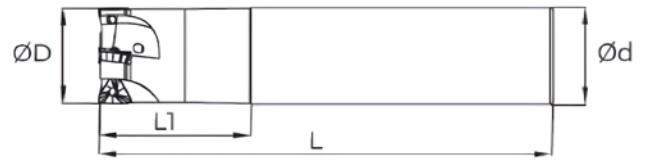

90°



Takım Kodu Order Code	Stok Durumu Stock Availability	D (mm)		L1 (mm)	L (mm)	d (mm)	Uç Insert	Vida Screw	Anahtar Torx Key
MST020-02-3P10-150-C	●	20	2	40	150	20	3PKT1004..	SM2,5X7	T08
MST025-03-3P10-150-C	●	25	3	50	150	25			
MST032-04-3P10-150-C	●	32	4	35	150	32			

● Stok ürün - Stock item

○ Stok dışı ürün - Non Stock item

△ Özel Sipariş - Special order

SAPLI TARAMALAR / INDEXABLE ENDMILLS

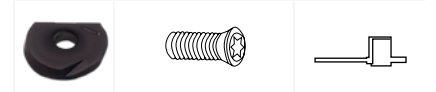
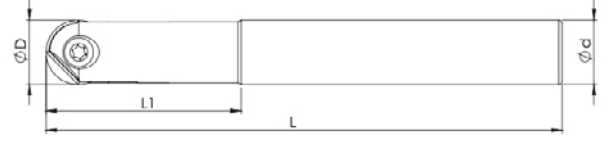

Takım Kodu Order Code	Stok Durumu Stock Availability	D (mm)	L1 (mm)	L (mm)	d (mm)	Uç Insert	Vida Screw	Anahtar Torx Key
MSW 08-01-RC08-130	○	8	36	130	10	RCE 08	SM3xd4,2xT08	T8
MSW 010-01-RC10-130	●	10	30	130	12	RCE 10	SM5x0,5x9	T15
MSW 012-01-RC12-150	●	12	32	130	12	RCE 12	SM5x0,5x10	T20
MSW 016-01-RC16-140	●	16	36	140	16	RCE 16	SM5x0,5x12	
MSW 020-01-RC20-200	●	20	45	160	20	RCE 20	SM4x0,5x17	
MSW 025-01-RC25-200	●	25	45	160	25	RCE 25	SM6x0,75x20	
MSW 030-01-RC30-200	○	30	66	200	32	RCE 30	SM8xd13x3Allen	A3
MSW 032-01-RC32-200	○	32	66	200	32	RCE 32		

SAPLI TARAMALAR / INDEXABLE ENDMILLS



90°

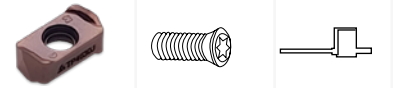

Takım Kodu Order Code	Stok Durumu Stock Availability	D (mm)		L1 (mm)	L (mm)	d (mm)	Uç Insert	Vida Screw	Anahtar Torx Key
MSY016-02-LN03-160-C	●	16	2	30	160	16			
MSY016-02-LN03-110-C	●	16	2	35	110	16			
MSY016-02-LN03-200-C	●	16	2	60	200	16			
MSY017-02-LN03-160-C	●	17	2	30	160	16			
MSY017-02-LN03-200-C	●	17	2	30	200	16			
MSY018-02-LN03-160-C	●	18	2	30	160	16			
MSY020-03-LN03-110-C	●	20	3	35	110	20			
MSY020-03-LN03-130-C	●	20	3	40	130	20			
MSY020-03-LN03-160-C	●	20	3	50	160	20			
MSY020-03-LN03-200-C	●	20	3	60	200	20			
MSY021-03-LN03-160-C	●	21	3	30	160	20			
MCY021-03-LN03-200-C	●	21	3	30	200	20	LNGX0303...	SM3x8	T08-T10
MSY022-03-LN03-180-C	●	22	3	30	180	20			
MSY025-04-LN03-160-C	●	25	4	50	160	25			
MSY025-04-LN03-180-C	●	25	4	50	180	25			
MSY026-04-LN03-180-C	●	26	4	30	180	25			
MSY026-04-LN03-200-C	●	26	4	30	200	25			
MSY026-04-LN03-250-C	●	26	4	30	250	25			
MSY028-04-LN03-160-C	●	28	4	30	160	25			
MSY028-04-LN03-200-C	●	28	4	30	200	25			
MSY032-05-LN03-160-C	●	32	5	50	160	32			
MSY032-05-LN03-200-C	●	32	5	60	200	32			
MSY033-05-LN03-160-C	●	33	5	40	160	32			

● Stok ürün - Stock item

○ Stok dışı ürün - Non Stock item

△ Özel Sipariş - Special order

SAPLI TARAMALAR / INDEXABLE ENDMILLS



90°

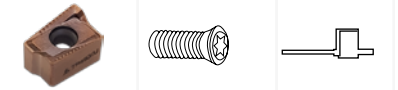

Takım Kodu Order Code	Stok Durumu Stock Availability	D (mm)		L1 (mm)	L (mm)	d (mm)	Uç Insert	Vida Screw	Anahtar Torx Key
MSK016-01-LN10-090-C	●	16	1	35	90	16	LNMX1006...	M3X8	T10
MSK018-02-LN10-120-C	●	18	2	30	120	16			
MSK020-02-LN10-100-C	●	20	2	35	100	20			
MSK020-02-LN10-150-C	●	20	2	50	150	20			
MSK025-02-LN10-115-C	●	25	2	35	115	25			
MSK025-03-LN10-115-C	●	25	3	35	115	25			
MSK025-03-LN10-150-C	●	25	3	50	150	25			
MSK032-04-LN10-125-C	●	32	4	40	125	32			
MSK032-04-LN10-150-C	●	32	4	50	150	32			
MSK032-04-LN10-200-C	●	32	4	60	200	32			
MSK040-04-LN10-130-C	●	40	4	40	130	32			
MSK040-05-LN10-130-C	●	40	5	40	130	32			

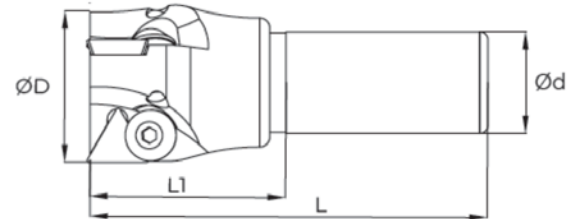

90°



Takım Kodu Order Code	Stok Durumu Stock Availability	D (mm)		L1 (mm)	L (mm)	d (mm)	Uç Insert	Vida Screw	Anahtar Torx Key
MSG035-02-TP16-100	●	35	2	50	100	25	TPKN16...	SM6X0,75	A4
MSG040-03-TP16-100	●	40	3	50	100	25			
MSG050-03-TP16-100	●	50	3	50	100	25			

● Stok ürün - Stock item

○ Stok dışı ürün - Non Stock item

▲ Özel Sipariş - Special order

SAPLI TARAMALAR / INDEXABLE ENDMILLS

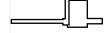
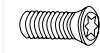
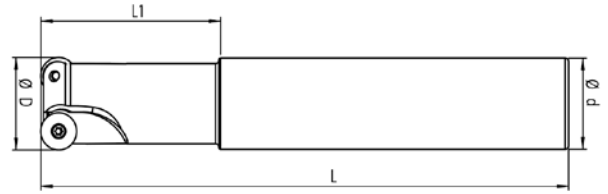

Takım Kodu Order Code	Stok Durumu Stock Availability	D (mm)		L1 (mm)	L (mm)	d (mm)	Uç Insert	Vida Screw	Anahtar Torx Key
MSG016-02-RD0803-120-C	●	16	2	40	120	16	RD... 0803	SM3X6	T10
MSG016-02-RD0803-150-C	●	16	2	40	150	16			
MSG017-02-RD0803-150-C	●	17	2	30	150	16			
MSG020-03-RD0803-150-C	●	20	3	50	150	20			
MSG020-02-RD1003-120-C	●	20	2	40	120	20	RD... 1003		
MSG020-02-RD1003-150-C	●	20	2	50	150	20			
MSG020-02-RD1003-200-C	●	20	2	50	200	20			
MSG025-02-RD1003-150-C	●	25	2	50	150	25			
MSG025-02-RD1003-200-C	●	25	2	60	200	25			
MSG032-02-RD1003-250-C	●	32	2	100	250	32			
MSG032-03-RD1003-150-C	●	32	3	60	150	32			
MSG032-03-RD1003-200-C	●	32	3	60	200	32			
MSG032-03-RD1003-250-C	●	32	3	100	250	32			
MSG020-02-RD10T3-150-C	●	20	2	50	150	20			
MSG025-02-RD10T3-150-C	●	25	2	50	150	25			
MSG025-02-RD10T3-200-C	●	25	2	70	200	25			
MSG032-02-RD10T3-250-C	●	32	2	100	250	32			
MSG032-03-RD10T3-250-C	●	32	3	100	250	32			
MSG032-03-RD10T3-150-C	●	32	3	70	150	32			
MSG032-03-RD10T3-160-C	●	32	3	50	160	32			
MSG040-02-RD10T3-250-C	●	40	2	55	250	32			
MSG040-04-RD10T3-150-C	●	40	4	55	150	32			

● Stok ürün - Stock item

○ Stok dışı ürün - Non Stock item

△ Özel Sipariş - Special order

SAPLI TARAMALAR / INDEXABLE ENDMILLS

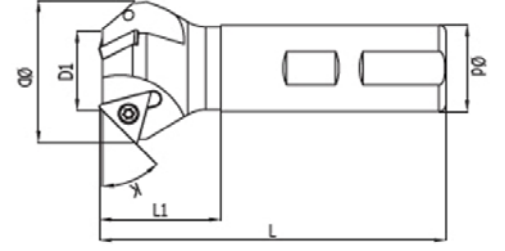

45°

60°

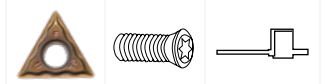

Takım Kodu Order Code	Stok Durumu Stock Availability	K	D (mm)		D1 (mm)	d (mm)	L (mm)	L1 (mm)	Uç Insert	Vida Screw	Anahtar Torx Key
MSG015-01-TC11-100	●	45°	15	1	4	16	L100	35	TCMT11..	M2,5X7	T08
MSG025-02-TC11-120	●	45°	25	2	14	16	L120	35			
MSG030-02-TC11-100	●	45°	30	2	16	16	L100	35			
MSG035-03-TC11-100	●	45°	35	3	21	16	L100	35			
MSG023-03-TC16-100	●	45°	23	3	5	16	L100	35	TCMT16..	M3,5X8	T15
MSG031-02-TC16-100	●	45°	31	2	10	16	L100	35			
MSG035-02-TC16-100	●	45°	35	2	14	20	L100	35			
MSG043-02-TC16-100	●	45°	43	2	22	25	L100	35			
MSG050-03-TC16-100	●	45°	50	3	30	25	L100	35			
MSG020-03-TC16-100	●	60°	20	3	6	16	L100	35			
MSG035-01-TC16-100	●	60°	35	1	20	20	L100	35			
MSG040-02-TC16-100	●	60°	40	2	24	25	L100	35			

● Stok ürün - Stock item

○ Stok dışı ürün - Non Stock item

▲ Özel Sipariş - Special order

SAPLI TARAMALAR / INDEXABLE ENDMILLS

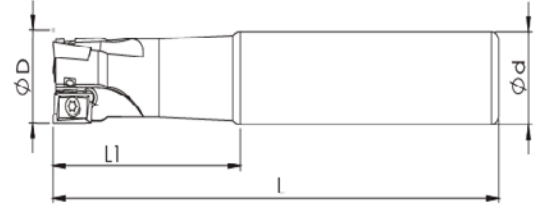
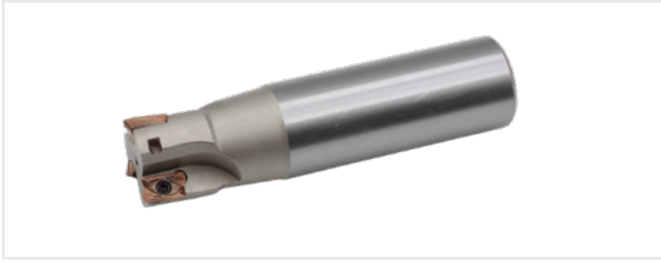

90°

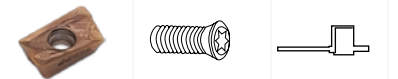

Takım Kodu Order Code	Stok Durumu Stock Availability	D (mm)		L1 (mm)	L (mm)	d (mm)	Uç Insert	Vida Screw	Anahtar Torx Key
MSS016-02-R311-150	●	16	2	44	150	16	R39011T3...	M2,5X6	T08
MSS016-02-R311-150-C	●	16	2	44	150	16			
MSS016-02-R311-100	○	16	2	35	100	16			
MSS020-03-R311-150	●	20	3	50	150	20			
MSS020-03-R311-150-C	●	20	3	50	150	20			
MSS020-03-R311-100	○	20	3	40	100	20			
MSS025-03-R311-150	●	25	3	50	150	25			
MSS025-03-R311-150-C	●	25	3	50	150	25			
MSS025-03-R311-100	●	25	3	35	100	25			

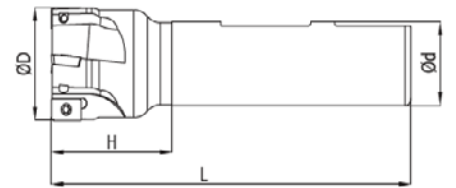

90°

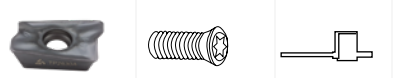

Takım Kodu Order Code	Stok Durumu Stock Availability	D (mm)		L1 (mm)	L (mm)	d (mm)	Uç Insert	Vida Screw	Anahtar Torx Key
MSE025-02-AP17-100-C	○	25	2	37	100	25	APKT1705...	SM4X8.4	T15
MSE032-03-AP17-110-C	○	32	3	39	110	32		M4X10	
MSE032-03-AP17-200-C	○	32	3	39	200	32			
MSE040-04-AP17-120-C	○	40	4	49	120	32			

● Stok ürün - Stock item

○ Stok dışı ürün - Non Stock item

△ Özel Sipariş - Special order

SAPLI TARAMALAR / INDEXABLE ENDMILLS

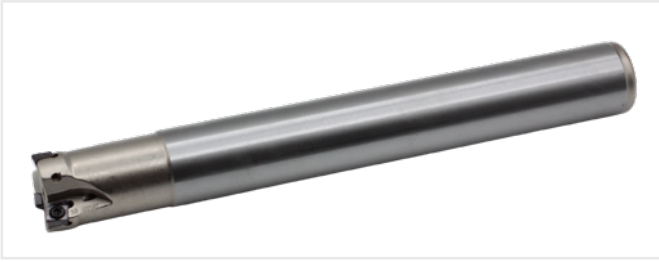

90°

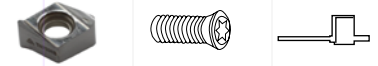

Takım Kodu Order Code	Stok Durumu Stock Availability	D (mm)		L1 (mm)	L (mm)	d (mm)	Uç Insert	Vida Screw	Anahtar Torx Key
MST016-02-SN06-120	●	16	2	40	120	16	SNKT0603...	M3X8	T10
MST016-02-SN06-150-C	●	16	2	50	150	16			
MST017-02-SN06-150	●	17	2	30	150	16			
MST017-02-SN06-150-C	●	17	2	30	150	16			
MST017-02-SN06-200-C	●	17	2	30	200	16			
MST018-02-SN06-150-C	●	18	2	30	150	16			
MST020-03-SN06-120-C	●	20	3	40	120	20			
MST021-03-SN06-160-C	●	21	3	30	160	20			
MST021-03-SN06-200-C	●	21	3	30	200	20			
MST022-03-SN06-160-C	●	22	3	30	160	20			
MST025-03-SN06-150-C	●	25	3	40	150	25			
MST025-03-SN06-200-C	●	25	3	60	200	25			
MST026-03-SN06-200-C	●	26	3	30	200	25			

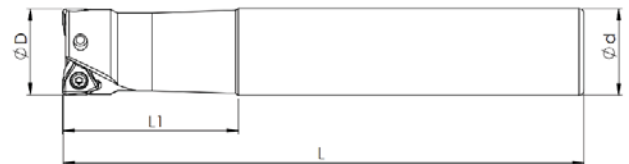

90°

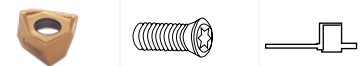

Takım Kodu Order Code	Stok Durumu Stock Availability	D (mm)		L1 (mm)	L (mm)	d (mm)	Uç Insert	Vida Screw	Anahtar Torx Key
MST025-02-6N06-150-C	○	25	2	50	150	25	6NGU0604...	M3X8	T10
MST032-03-6N06-150-C	○	32	3	50	150	32			

● Stok ürün - Stock item

○ Stok dışı ürün - Non Stock item

▲ Özel Sipariş - Special order

SAPLI TARAMALAR / INDEXABLE ENDMILLS

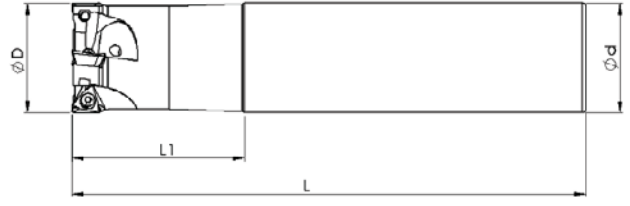

90°

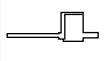

Takım Kodu Order Code	Stok Durumu Stock Availability	D (mm)		L1 (mm)	L (mm)	d (mm)	Uç Insert	Vida Screw	Anahtar Torx Key
MST032-03-3P15-150-C	●	32	3	30	150	25	3PKT1505...	M4,5X12	T20
MST032-03-3P15-200-C	●	32	3	60	200	32			

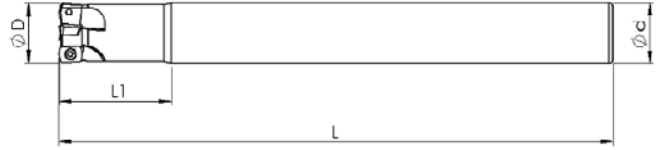
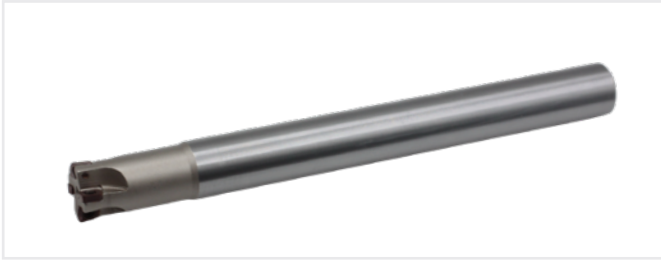

90°

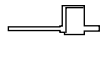

Takım Kodu Order Code	Stok Durumu Stock Availability	D (mm)		L1 (mm)	L (mm)	d (mm)	Uç Insert	Vida Screw	Anahtar Torx Key
MSY010-02-LP01-100	●	10	2	20	100	10	LPGU0102..	M2X5	T06
MSY011-02-LP01-120	●	11	2	22	120	10			
MSY012-02-LP01-120	●	12	2	20	120	11			
MSY012-03-LP01-120	●	12	3	20	120	11			
MSY012-02-LP01-100	●	12	2	25	100	12			
MSY012-02-LP01-120	●	12	2	25	120	12			
MSY012-03-LP01-120	●	12	3	25	120	12			
MSY012-03-LP01-150	●	12	3	80	150	12			
MSY014-03-LP01-120	●	14	3	30	120	14			
MSY016-04-LP01-160	●	16	4	30	160	16			

● Stok ürün - Stock item

○ Stok dışı ürün - Non Stock item

△ Özel Sipariş - Special order

SAPLI TARAMALAR / INDEXABLE ENDMILLS

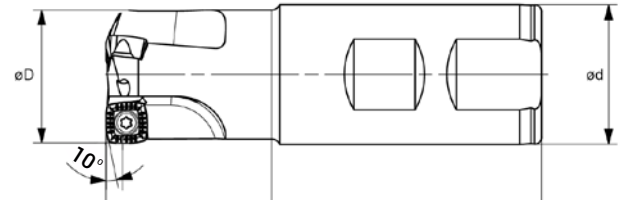
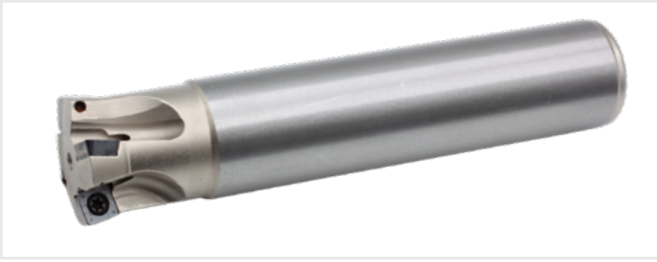

10°



Takım Kodu Order Code	Stok Durumu Stock Availability	D (mm)		L1 (mm)	L (mm)	d (mm)					
							Uç Insert	Vida Screw	Pabuç Clamp	Vida Screw	Anahtar Torx Key
MSZ022-02-SD09-170-C	●	22	2	25	170	20	SDMT09T3...	M3,5X8	CK14	M3,5X10	T15
MSZ025-02-SD09-160-C	●	25	2	40	160	25					
MSZ025-03-SD09-160-C	●	25	3	50	160	25					
MSZ025-02-SD09-200-C	●	25	2	60	200	25					
MSZ025-03-SD09-200-C	●	25	3	60	200	25					
MSZ026-02-SD09-160-C	●	26	2	30	160	25					
MSZ026-03-SD09-160-C	●	26	3	30	160	25					
MSZ026-02-SD09-200-C	●	26	2	30	200	25					
MSZ032-03-SD09-150-C	●	32	3	50	150	32					
MSZ032-03-SD09-160-C	●	32	3	50	160	32					
MSZ032-03-SD09-200-C	●	32	3	60	200	32					
MSZ033-03-SD09-160-C	●	33	3	40	160	32					
MSZ033-03-SD09-200-C	●	33	3	30	200	32					
MSZ033-03-SD09-250-C	●	33	3	30	250	32					
MSZ035-04-SD09-160-C	●	35	4	30	160	32					
MSZ042-04-SD09-160-C	●	42	4	40	160	32					



90°



Takım Kodu Order Code	Stok Durumu Stock Availability	D (mm)		L1 (mm)	L (mm)	d (mm)			
							Uç Insert	Vida Screw	Anahtar Torx Key
MSE040-05-LN13-C	○	40	5	49	120	32	LNHU1306...	M4X11.5	T15

● Stok ürün - Stock item

○ Stok dışı ürün - Non Stock item

▲ Özel Sipariş - Special order

SAPLI TARAMALAR / INDEXABLE ENDMILLS

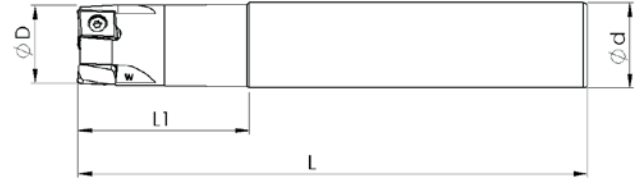

90°



Takım Kodu Order Code	Stok Durumu Stock Availability	D (mm)		L1 (mm)	L (mm)	d (mm)	Uç Insert	Vida Screw	Anahtar Torx Key
MSE020-02-LN09-110	○	20	2	30	110	20	LNHU0904...	M3X8.3	T09
MSE020-03-LN09-110	○	20	3	30	110	20			
MSE021-02-LN09-200	○	21	2	30	200	20			
MSE025-03-LN09-200-C	○	25	3	34	200	25			
MSE025-04-LN09-200-C	○	25	4	34	200	25			
MSE026-03-LN09-200-C	○	26	3	34	200	25			
MSE028-03-LN09-110-C	○	28	3	34	110	25			
MSE032-04-LN09-250-C	○	32	4	45	250	32			
MSE032-05-LN09-250-C	○	32	5	45	250	32			
MSE033-04-LN09-250-C	○	33	4	45	250	32			

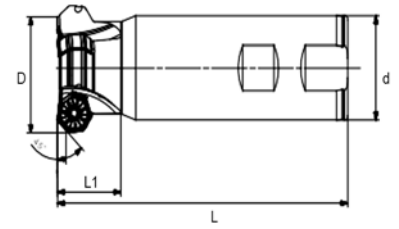

45°



Takım Kodu Order Code	Stok Durumu Stock Availability	D (mm)		L1 (mm)	L (mm)	d (mm)	Uç Insert	Vida Screw	Anahtar Torx Key	Altık Shim	Altık Vidası Shim Screw	Altık Vidası Anahtar Shim Screw Wrench
MSE040-03-XN07-C	○	40	3	28.3	130	40	XNMU0705...	SM3.5X12	T15	S-XN07030	SM5X8.5	A3.5

SAPLI TARAMALAR / INDEXABLE ENDMILLS

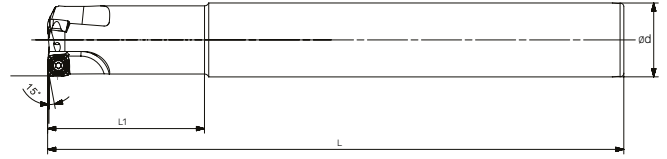

15°



Takım Kodu Order Code	Stok Durumu Stock Availability	D (mm)		L1 (mm)	L (mm)	d (mm)	Uç Insert	Vida Screw	Anahtar Torx Key
MSE025-02-SD09-200-C	●	25	2	48	200	25			
MSE026-02-SD09-180-C	●	26	2	28	180	25	SDMT0904...	M3.5X8.6	T10
MSE032-03-SD09-250-C	●	32	3	67	250	32			

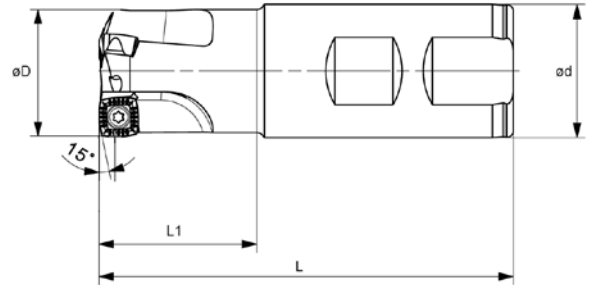

15°



Takım Kodu Order Code	Stok Durumu Stock Availability	D (mm)		L1 (mm)	L (mm)	d (mm)	Uç Insert	Vida Screw	Anahtar Torx Key
MSE025-02-SD09-96-C	●	25	2	37	96	25			
MSE032-02-SD09-100-C	●	32	2	37	100	32	SDMT0904...	M3.5X8.6	T10

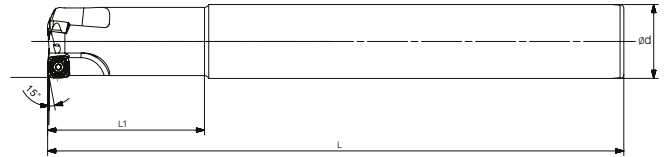

15°



Takım Kodu Order Code	Stok Durumu Stock Availability	D (mm)		L1 (mm)	L (mm)	d (mm)	Uç Insert	Vida Screw	Anahtar Torx Key
MSE032-02-SD15-250-C	●	32	2	70	250	32	SDMT1205...	M4X11.2	T15

● Stok ürün - Stock item

○ Stok dışı ürün - Non Stock item

▲ Özel Sipariş - Special order

SAPLI TARAMALAR / INDEXABLE ENDMILLS

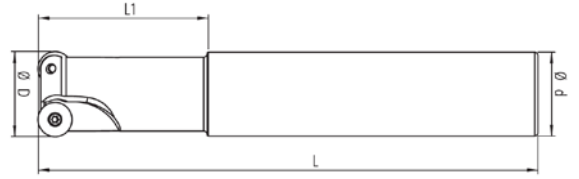

Takım Kodu Order Code	Stok Durumu Stock Availability	D (mm)		L1 (mm)	L (mm)	d (mm)	Uç Insert	Vida Screw	Anahtar Torx Key
MSE015-03-RP10-225-C	●	15	3	56.2	225	25	RPHX10T3...	M3X7.2	T09
MSE022-04-RP10-130-C	●	22	4	65	130	32			

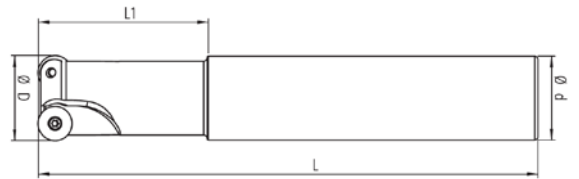

Takım Kodu Order Code	Stok Durumu Stock Availability	D (mm)		L1 (mm)	L (mm)	d (mm)	Uç Insert	Vida Screw	Anahtar Torx Key
MSE032-03-RP12-120-C	○	32	3	33	120	32	RPHX1204...	M4X8.5	T10

SAPLI TARAMALAR / INDEXABLE ENDMILLS

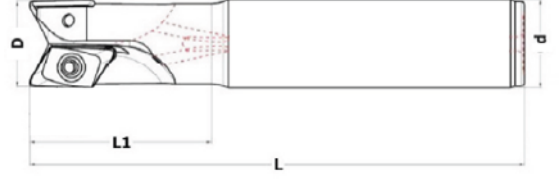

90°

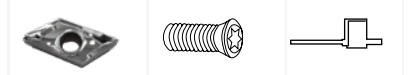

Takım Kodu Order Code	Stok Durumu Stock Availability	D (mm)		L1 (mm)	L (mm)	d (mm)	Uç Insert	Vida Screw	Anahtar Torx Key
MSK020-01-XE19-150-C	○	20	1	50	150	20	XEKT19...	SM4X10	T15
MSK025-02-XE19-150-C	○	25	2	50	150	25			
MSK032-02-XE19-150-C	○	32	2	50	150	32			
MSK040-03-XE19-150-C	○	40	3	60	150	32			

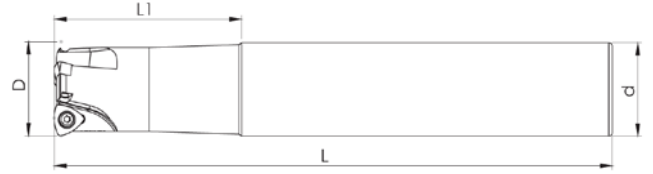

14°



Takım Kodu Order Code	Stok Durumu Stock Availability	D (mm)		L1 (mm)	L (mm)	d (mm)	Uç Insert	Vida Screw	Anahtar Torx Key
MSK025-02-W N09-150-C	●	25	2	70	150	25	WNGX09T3..	SM3X8	T10
MSK032-03-W N09-150-C	●	32	3	70	150	32			

● Stok ürün - Stock item

○ Stok dışı ürün - Non Stock item

▲ Özel Sipariş - Special order

FREZE KAFALARI / FACE MILLS

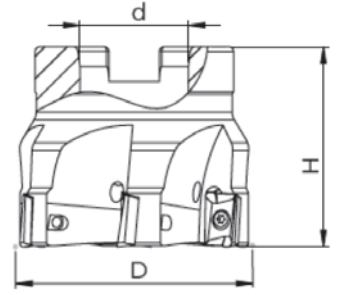

90°



Takım Kodu Order Code	Stok Durumu Stock Availability	D (mm)		H (mm)	d (mm)			
						Uç Insert	Vida Screw	Anahtar Torx Key
MCG040-05-AP10	●	40	5	45	16	APKT1003...	SM2,5X7	T08
MCG040-05-AP10-C	●	40	5	45	16			
MCG050-06-AP10	●	50	6	45	22			
MCG050-06-AP10-C	●	50	6	45	22			
MCG063-06-AP10	●	63	6	45	22			
MCG063-07-AP10	●	63	7	45	22			
MCG063-07-AP10-C	●	63	7	45	22			
MCG080-08-AP10	●	80	8	52	27			
MCG080-08-AP10-C	●	80	8	52	27			
MCG100-09-AP10	●	100	9	52	32			
MCG100-09-AP10-C	●	100	9	52	32			

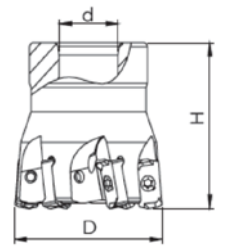

90°



Takım Kodu Order Code	Stok Durumu Stock Availability	D (mm)		H (mm)	d (mm)			
						Uç Insert	Vida Screw	Anahtar Torx Key
MCY040-06-LN03-C	●	40	6	40	17	LNGX0303...	SM3X7	T08
MCY050-06-LN03-C	●	50	6	50	22			
MCY050-07-LN03-C	●	50	7	50	22			
MCY052-06-LN03-C	●	52	6	50	22			

● Stok ürün - Stock item

○ Stok dışı ürün - Non Stock item

△ Özel Sipariş - Special order

FREZE KAFALARI / FACE MILLS

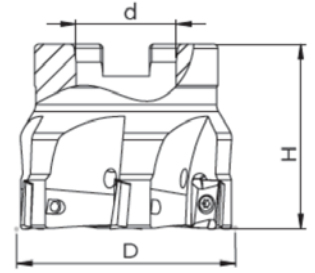

90°



Takım Kodu Order Code	Stok Durumu Stock Availability	D (mm)		H (mm)	d (mm)		Uç Insert		Vida Screw		Anahtar Torx Key
MCG040-05-AP11	●	40	5	45	16	APKT1103...	APKT1103...		SM2,5X7		T08
MCG050-06-AP11	●	50	6	50	22						
MCG063-07-AP11	●	63	7	50	22						
MCG040-04-AP16	●	40	4	45	16	APKT16T3...	APKT16T3...		SM4X12		T15
MCG050-05-AP16	●	50	5	45	22						
MCG063-05-AP16	●	63	5	45	22						
MCG080-07-AP16	●	80	7	52	27						

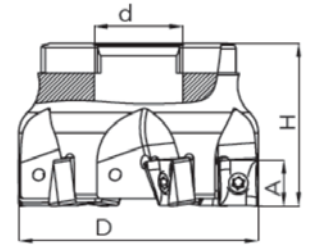

90°



Takım Kodu Order Code	Stok Durumu Stock Availability	D (mm)		H (mm)	d (mm)		Uç Insert		Vida Screw		Anahtar Torx Key
MCK040-04-LN10-C	●	40	4	40	16	LNMX1006...	LNMX1006...		SM3X10		T10
MCK040-05-LN10-C	●	40	5	40	16						
MCK050-06-LN10-C	●	50	6	40	22						
MCK050-04-LN15-C	●	50	4	40	22	LNMX1510...	LNMX1510...		SM4X14		T15
MCK063-06-LN15-C	●	63	6	40	22						
MCK080-07-LN15-C	●	80	7	52	27						
MCK100-08-LN15-C	●	100	8	52	32						
MCK125-10-LN15	●	125	10	62	40						
MCK160-12-LN15	●	160	12	62	40						

● Stok ürün - Stock item

○ Stok dışı ürün - Non Stock item

△ Özel Sipariş - Special order

FREZE KAFALARI / FACE MILLS

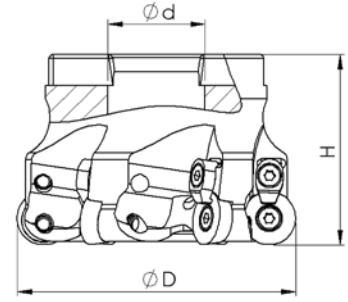

90°



Takım Kodu Order Code	Stok Durumu Stock Availability	D (mm)		H(mm)	d (mm)													
						Uç Insert	Vida Screw	Pabuç Clamp	Vida Screw	Anahtar Torx Key								
MCG040-04-RD1003-C	●	40	4	40	16	RD..1003	SM3,5X10	CCK14M	SM3,5X8	T15								
MCG050-05-RD1003-C	●	50	5	46	22													
MCG063-06-RD1003-C	●	63	6	50	22													
MCG080-07-RD1003-C	●	80	7	52	27													
MCG100-08-RD1003-C	●	100	8	52	32													
MCG050-05-RD10T3-C	●	50	5	40	22	RD..10T3					SM3,5X10	CCK14M	SM3,5X8	T15				
MCG063-06-RD10T3-C	●	63	6	40	22													
MCG080-07-RD10T3-C	●	80	7	50	27													
MCG040-04-RD12T3-C	●	40	4	40	16	RD..12T3									SM3,5X10	CCK14M	SM3,5X8	T15
MCG050-05-RD12T3-C	●	50	5	46	22													
MCG052-05-RD12T3-C	●	52	5	46	22													
MCG063-06-RD12T3-C	●	63	6	50	22													
MCG080-07-RD12T3-C	●	80	7	52	27													
MCG100-08-RD12T3-C	●	100	8	52	32													
MCG125-09-RD12T3	●	125	9	62	40													
MCG160-10-RD12T3	●	160	10	62	40													
MCG160-10-RD12T3-C	●	160	10	62	40	RD..1604	SMSX12	CTP11M	SM4X11	T20								
MCG050-04-RD1604-C	●	50	4	50	22													
MCG052-04-RD1604-C	●	52	4	50	22													
MCG063-04-RD1604-C	●	63	4	50	22													
MCG066-05-RD1604-C	●	66	5	50	27													
MCG080-05-RD1604-C	●	80	5	52	27													
MCG100-06-RD1604-C	●	100	6	52	32													
MCG125-07-RD1604	●	125	7	62	40													
MCG160-08-RD1604	●	160	8	62	40													

● Stok ürün - Stock item

○ Stok dışı ürün - Non Stock item

△ Özel Sipariş - Special order

FREZE KAFALARI / FACE MILLS

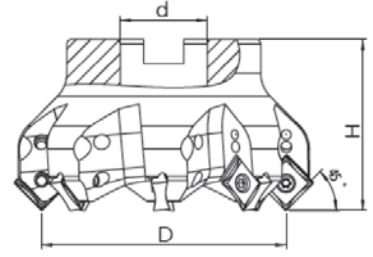

45°



Takım Kodu Order Code	Stok Durumu Stock Availability	D (mm)		H (mm)	d (mm)					
						Uç Insert	Vida Screw	Pabuç Clamp	Vida Screw	Anahtar Torx Key
MCK050-05-SN12-45	●	50	5	40	22	SNMX1205 SNMX1206	SM4X11	CCK15M	M4X11	T15
MCK063-06-SN12-45	●	63	6	40	22					
MCK080-08-SN12-45	●	80	8	50	27					
MCK100-10-SN12-45	●	100	10	50	32					
MCK125-11-SN12-45	●	125	11	62	40					
MCK160-12-SN12-45	●	160	12	62	40					

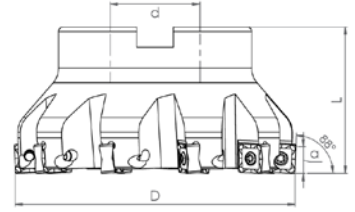

88°



Takım Kodu Order Code	Stok Durumu Stock Availability	D (mm)		H (mm)	d (mm)			
						Uç Insert	Vida Screw	Anahtar Torx Key
MCK050-05-SN12-88-C	●	50	5	40	22	SNMX1206...	SM4,5X11	T20
MCK063-06-SN12-88-C	●	63	6	40	22			
MCK080-08-SN12-88-C	●	80	8	50	27			
MCK100-10-SN12-88-C	●	100	10	50	32			
MCK125-11-SN12-88	●	125	11	62	40			
MCK160-12-SN12-88	●	160	12	62	50			
MCK200-14-SN12-88	●	200	14	62	60			

* SNMX1205 uçlar için SM4x12x6 civata kullanınız. * Use SM4x12x6 screws for SNMX1205 inserts.

● Stok ürün - Stock item

○ Stok dışı ürün - Non Stock item

▲ Özel Sipariş - Special order

FREZE KAFALARI / FACE MILLS

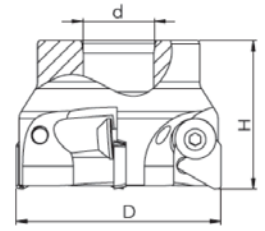

90°

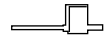

Takım Kodu Order Code	Stok Durumu Stock Availability	D (mm)		H (mm)	d (mm)	Uç Insert	Vida Screw	Anahtar Torx Key
MCG050-03-TP16	●	50	3	41	22	TPKN16...	SM6X0,75	A4
MCG063-04-TP16	●	63	4	48	22			
MCG080-05-TP16	●	80	5	52	32			
MCG100-06-TP16	●	100	6	52	32			
MCG063-03-TP22	●	63	3	48	22	TPKN22...	SM8X1	A5
MCG080-04-TP22	●	80	4	52	32			
MCG100-05-TP22	●	100	5	52	32			
MCG125-06-TP22	●	125	6	62	40			
MCG160-07-TP22	●	160	7	62	40			
MCG200-08-TP22	●	200	8	62	60			
MCG250-10-TP22	●	250	10	62	60			

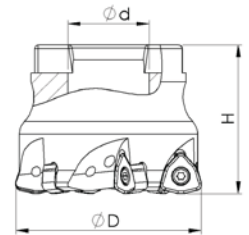

14°

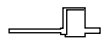

Takım Kodu Order Code	Stok Durumu Stock Availability	D (mm)		H (mm)	d (mm)	Uç Insert	Vida Screw	Anahtar Torx Key
MCK040-04-W N09-C	●	40	4	40	16	WNGX09T3...	SM3X10	T10
MCK050-04-W N09-C	●	50	4	40	22			
MCK052-04-W N09-C	●	52	4	40	22			
MCK052-05-W N09-C	●	52	5	40	22			
MCK052-06-W N09-C	●	52	6	40	22			
MCK063-05-W N09-C	●	63	5	40	22			
MCK066-06-W N09-C	●	66	6	50	22			
MCK066-06-W N09-C	●	66	6	50	27			

FREZE KAFALARI / FACE MILLS

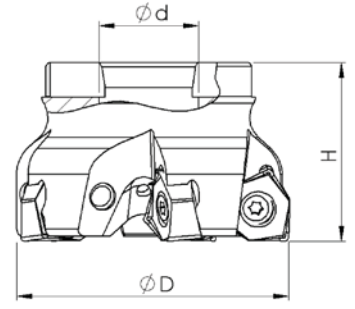

90°



Takım Kodu Order Code	Stok Durumu Stock Availability	D (mm)		H (mm)	d (mm)	Uç Insert	Vida Screw	Anahtar Torx Key
MCY050-04-W N08-C	●	50	4	40	22	W NMU0806...	SM5X12	T20
MCY052-04-W N08-C	●	52	4	40	22			
MCY063-05-W N08-C	●	63	5	40	22			
MCY080-06-W N08-C	●	80	6	45	27			
MCY100-07-W N08-C	●	100	7	50	32			
MCY125-08-W N08	●	125	8	50	40			
MCY160-10-W N08	●	160	10	62	40			
MCY200-12-W N08	●	200	12	62	50			

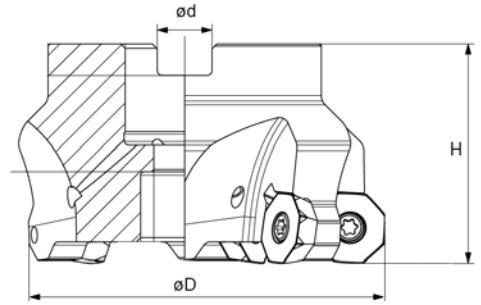

45°



Takım Kodu Order Code	Stok Durumu Stock Availability	D (mm)		H (mm)	d (mm)	Uç Insert	Vida Screw	Anahtar Torx Key
MCA050-04-XN07	●	50	4	40	22	XNMU0705...	SM4X10	T15
MCA063-05-XN07	●	63	5	40	22			
MCA080-06-XN07	●	80	6	50	27			
MCA100-07-XN07	●	100	7	50	32			
MCA125-08-XN07	●	125	8	55	40			
MCA160-10-XN07	●	160	10	55	40			

● Stok ürün - Stock item

○ Stok dışı ürün - Non Stock item

▲ Özel Sipariş - Special order

FREZE KAFALARI / FACE MILLS

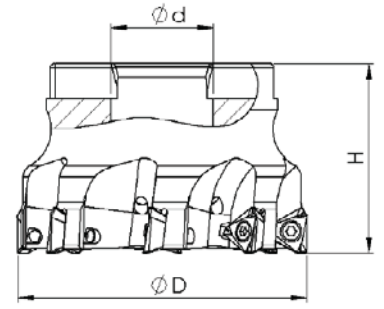

90°



Takım Kodu Order Code	Stok Durumu Stock Availability	D (mm)		H (mm)	d (mm)	Uç Insert	Vida Screw	Anahtar Torx Key
MCT050-04-3P15-C	●	50	4	40	22	3PKT1505...	M4,5X12	T20
MCT063-05-3P15-C	●	63	5	40	22			
MCT080-07-3P15-C	●	80	7	50	27			
MCT100-08-3P15-C	●	100	8	50	32			
MCT040-04-3P10-C	●	40	4	40	16	3PKT1004...	M3X8	T10
MCT050-05-3P10-C	●	50	5	40	22			
MCT063-08-3P10-C	●	63	8	40	22			

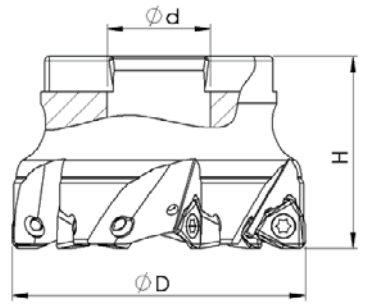

90°



Takım Kodu Order Code	Stok Durumu Stock Availability	D (mm)		H (mm)	d (mm)	Uç Insert	Vida Screw	Anahtar Torx Key
MCT040-04-6N06-C	●	40	4	40	16	6NGU0604...	M3X8	T10
MCT050-05-6N06-C	●	50	5	40	22			
MCT063-06-6N06-C	●	63	6	40	22			
MCT050-05-6N09-C	●	50	5	40	22	6NGU0905...	M4X11	T15
MCT063-06-6N09-C	●	63	6	40	22			
MCT080-07-6N09-C	●	80	7	50	27			
MCT100-08-6N09-C	●	100	8	50	32			
MCT125-10-6N09	●	125	10	62	40			

● Stok ürün - Stock item

○ Stok dışı ürün - Non Stock item

△ Özel Sipariş - Special order

FREZE KAFALARI / FACE MILLS

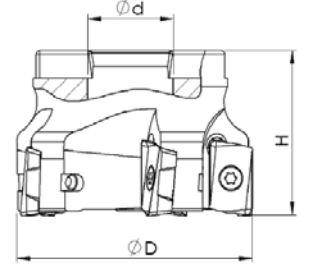

90°



Takım Kodu Order Code	Stok Durumu Stock Availability	D (mm)		H (mm)	d (mm)	Uç Insert	Vida Screw	Anahtar Torx Key
MCS040-05-R311-C	●	40	5	40	16	R39011T3...	M2,5X7	T08
MCS050-06-R311-C	●	50	6	40	22			
MCS063-07-R311-C	●	63	7	50	22			

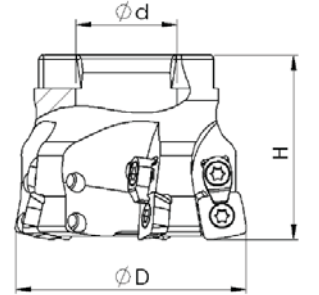

10°



Takım Kodu Order Code	Stok Durumu Stock Availability	D (mm)		H (mm)	d (mm)	Uç Insert	Vida Screw	Pabuç Clamp	Vida Screw	Anahtar Torx Key
MCZ040-04-SD09-C	●	40	4	40	16	SDMT09T3...	M3,5X11	CCK14M	M3,5X11	T15
MCZ050-04-SD09-C	●	50	4	40	22					
MCZ050-05-SD09-C	●	50	5	40	22					
MCZ052-05-SD09-C	●	52	5	40	22					
MCZ052-06-SD09-C	●	52	6	40	22					
MCZ060-06-SD09-C	●	60	6	40	22					
MCZ063-06-SD09-C	●	63	6	40	22					
MCZ080-07-SD09-C	●	80	7	50	27					
MCZ100-08-SD09-C	●	100	8	50	32					

● Stok ürün - Stock item

○ Stok dışı ürün - Non Stock item

▲ Özel Sipariş - Special order

FREZE KAFALARI / FACE MILLS

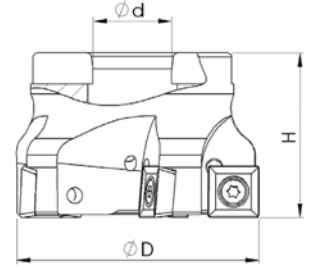
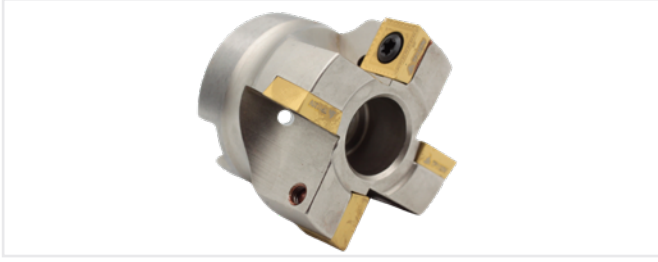

90°



Takım Kodu Order Code	Stok Durumu Stock Availability	D (mm)		H (mm)	d (mm)			
						Uç Insert	Vida Screw	Anahtar Torx Key
MCW 050-04-SP12-C	●	50	4	45	22	SPMT1204...	M4,5X12	T20
MCW 063-05-SP12-C	●	63	5	50	22			

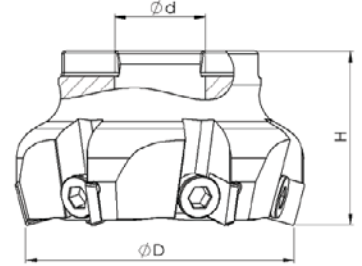

75°



Takım Kodu Order Code	Stok Durumu Stock Availability	D (mm)		H (mm)	d (mm)			
						Uç Insert	Vida Screw	Anahtar Torx Key
MCG063-05-SP12	●	63	5	40	22	SPKN1203...	M8X1 L	A6
MCG080-06-SP12	●	80	6	50	27			
MCG100-08-SP12	●	100	8	50	32			
MCG125-10-SP12	●	125	10	62	40			
MCG160-12-SP12	●	160	12	62	40			
MCG200-12-SP12	●	200	12	62	60			

● Stok ürün - Stock item

○ Stok dışı ürün - Non Stock item

△ Özel Sipariş - Special order

FREZE KAFALARI / FACE MILLS

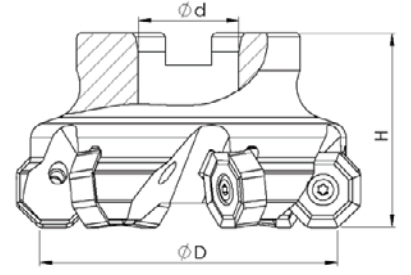

45°



Takım Kodu Order Code	Stok Durumu Stock Availability	D (mm)		H (mm)	d (mm)	 Uç Insert	 Vida Screw	 Anahtar Torx Key
MCZ050-04-0 N08-C	●	50	4	50	22	ONHU08T6...	M4,5X15	T20
MCZ080-06-0 N08-C	●	80	6	50	27			
MCZ100-07-0 N08-C	●	100	7	50	32			
MCZ125-08-0 N08	●	125	8	62	40			
MCZ160-10-0 N08	●	160	10	62	40			

FREZE KAFALARI / FACE MILLS

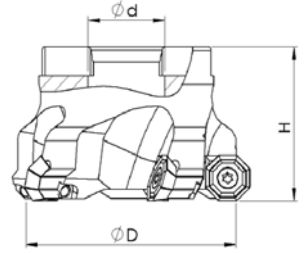

40°



Takım Kodu Order Code	Stok Durumu Stock Availability	D (mm)		H (mm)	d (mm)		Vida Screw	Anahtar Torx Key
MCE050-04-OD06-C	○	50	4	40	16	ODMT0605...	M4.5X12 A43	T20
MCE063-05-OD06-C	○	63	5	40	22			
MCE80-05-OD06-C	○	80	5	50	27			
MCE080-06-OD06-C	○	80	6	50	27			
MCE100-06-OD06-C	○	100	6	50	32			
MCE100-07-OD06-C	○	100	7	50	32			
MCE125-07-OD06-C	○	125	7	63	40			
MCE125-08-OD06-C	○	125	8	63	40			
MCE160-10-OD06	○	160	10	63	40			

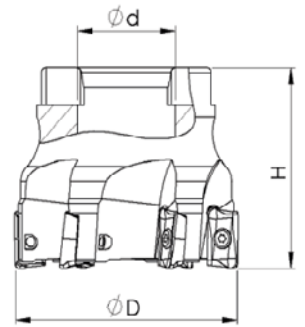
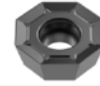

90°



Takım Kodu Order Code	Stok Durumu Stock Availability	D (mm)		H (mm)	d (mm)		Vida Screw	Anahtar Torx Key
MCE050-05-AP17-C	○	50	5	40	22	APKT1705...	SM4X10	T15
MCE063-06-AP17-C	●	63	6	40	22			
MCE080-06-AP17-C	●	80	6	50	27			
MCE100-08-AP17-C	○	100	8	50	32			



FREZE KAFALARI / FACE MILLS

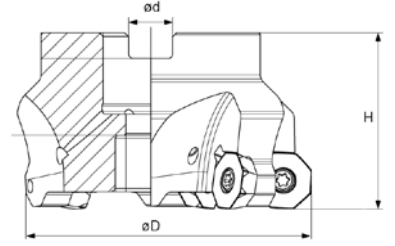

45°



Takım Kodu Order Code	Stok Durumu Stock Availability	D (mm)		H (mm)	d (mm)
MCE040-03-XN07-C	○	40	3	40	6
MCE050-04-XN07-C	○	50	4	40	22
MCE050-05-XN07-C	○	50	5	40	22
MCE063-05-XN07-C	●	63	5	40	22
MCE063-06-XN07-C	●	63	6	40	22
MCE080-06-XN07-C	●	80	6	50	27
MCE080-07-XN07-C	●	80	7	50	27
MCE100-07-XN07-C	●	100	7	50	32
MCE100-08-XN07-C	●	100	8	50	32
MCE125-08-XN07-C	●	125	8	63	40
MCE125-10-XN07-C	○	125	10	63	40
MCE160-09-XN07	○	160	9	63	40
MCE160-12-XN07	○	160	12	63	40
MCE200-14-XN07	○	200	14	63	60

Uç Insert	Vida Screw	Anahtar Torx Key	Altık Shim	Altık Vidası Shim Screw	Altık Vidası Anahtar Shim Screw Wrench
XNMU0705...	M3.5X12	T15	S-XN07030	SS0585F	A3.5

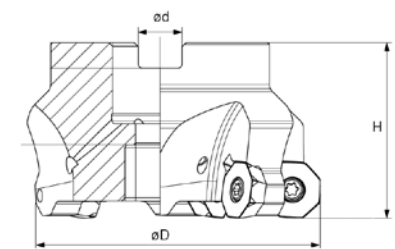
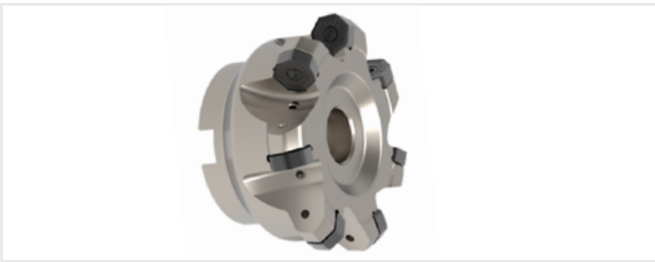

45°



Takım Kodu Order Code	Stok Durumu Stock Availability	D (mm)		H (mm)	d (mm)
MCE063-05-XN09-C	○	63	5	40	22
MCE080-06-XN09-C	○	80	6	50	27
MCE100-07-XN09-C	○	100	7	50	32
MCE100-08-XN09-C	○	100	8	50	32
MCE125-08-XN09-C	○	125	8	63	40
MCE125-10-XN09-C	○	125	10	63	40
MCE160-09-XN09	○	160	9	63	40
MCE160-11-XN09	○	160	11	63	40
MCE200-12-XN09	○	200	12	63	60
MCE250-12-XN09	△	250	12	63	60
MCE315-14-XN09	△	315	14	63	60

Uç Insert	Vida Screw	Anahtar Torx Key	Altık Shim	Altık Vidası Shim Screw	Altık Vidası Anahtar Shim Screw Wrench
XNMU0906...	M5X13	T20	S-XN09040	SS0810F	A5

FREZE KAFALARI / FACE MILLS

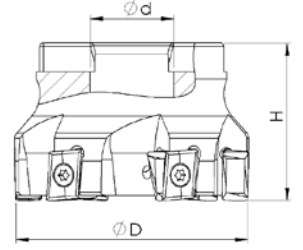
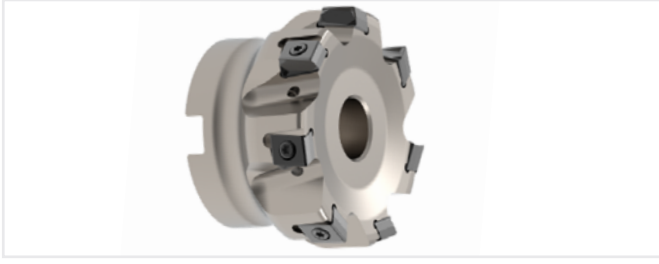

90°



Takım Kodu Order Code	Stok Durumu Stock Availability	D (mm)		H (mm)	d (mm)			
						Uç Insert	Vida Screw	Anahtar Torx Key
MCE040-04-LN09-C	○	40	4	40	16	LNHU0904...	SM3X8.3	T09
MCE040-06-LN09-C	○	40	6	40	16			
MCE050-05-LN09-C	○	50	5	40	22			
MCE050-07-LN09-C	○	50	7	40	22			
MCE063-07-LN09-C	○	63	7	40	22			
MCE063-10-LN09-C	○	63	10	40	22			
MCE080-09-LN09-C	○	80	9	50	27			
MCE080-13-LN09-C	○	80	13	50	27			

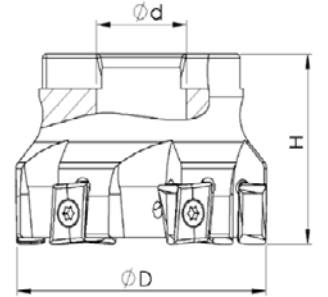
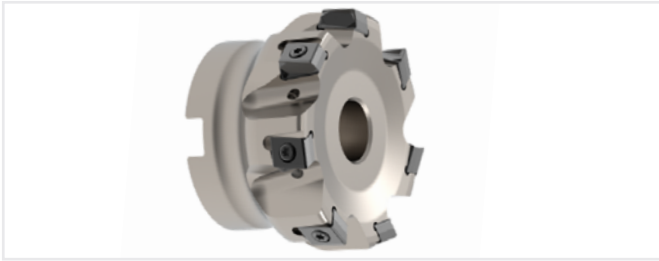

90°



Takım Kodu Order Code	Stok Durumu Stock Availability	D (mm)		H (mm)	d (mm)			
						Uç Insert	Vida Screw	Anahtar Torx Key
MCE063-04-LN16-C	○	63	4	40	22	LNHU1607...	M5X13 A63	T20
MCE080-05-LN16-C	○	80	5	50	27			
MCE100-06-LN16-C	○	100	6	50	32			
MCE125-07-LN16-C	○	125	7	63	40			
MCE160-08-LN16-C	○	160	8	63	40			

● Stok ürün - Stock item

○ Stok dışı ürün - Non Stock item

△ Özel Sipariş - Special order

FREZE KAFALARI / FACE MILLS

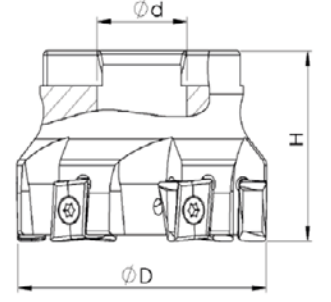
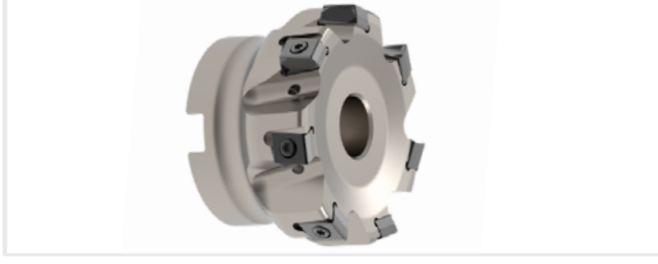

90°



Takım Kodu <i>Order Code</i>	Stok Durumu <i>Stock Availability</i>	D (mm)		H (mm)	d (mm)			
						Uç <i>Insert</i>	Vida <i>Screw</i>	Anahtar <i>Torx Key</i>
MCE040-04-LN13-C	○	40	4	40	16	LNHU1306...	SM4X11.2	T15
MCE040-05-LN13-C	○	40	5	40	16			
MCE050-05-LN13-C	○	50	5	40	22			
MCE050-06-LN13-C	○	50	6	40	22			
MCE063-04-LN13-C	○	63	4	40	22			
MCE063-06-LN13-C	○	63	6	40	22			
MCE063-08-LN13-C	○	63	8	40	22			
MCE080-05-LN13-C	○	80	5	50	27			
MCE080-07-LN13-C	○	80	7	50	27			
MCE080-10-LN13-C	○	80	10	50	27			
MCE100-07-LN13-C	○	100	7	50	32			
MCE100-09-LN13-C	○	100	9	50	32			
MCE100-13-LN13-C	○	100	13	50	32			
MCE125-09-LN13-C	○	125	9	63	40			
MCE125-11-LN13-C	○	125	11	63	40			
MCE125-16-LN13-C	○	125	16	63	40			
MCE160-09-LN13	○	160	9	63	40			
MCE160-13-LN13	○	160	13	63	40			
MCE200-12-LN13	○	200	12	63	60			
MCE250-12-LN13	○	250	12	63	60			

FREZE KAFALARI / FACE MILLS

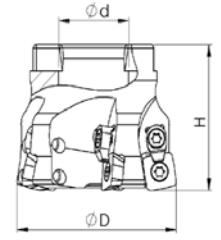
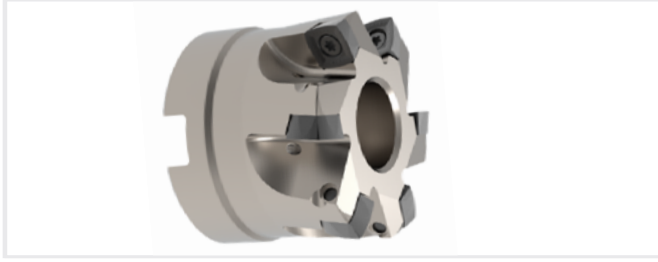

15°



Takım Kodu <i>Order Code</i>	Stok Durumu <i>Stock Availability</i>	D (mm)		H (mm)	d (mm)	Uç <i>Insert</i>	Vida <i>Screw</i>	Anahtar <i>Torx Key</i>
MCE040-03-SD09-C	○	40	3	32	16	SDMT0904...	M3.5X8.6	T10
MCE040-04-SD09-C	●	40	4	32	16			
MCE040-05-SD09-C	○	40	5	32	16			
MCE050-05-SD09-C	●	50	5	40	22			
MCE050-06-SD09-C	○	50	6	40	22			

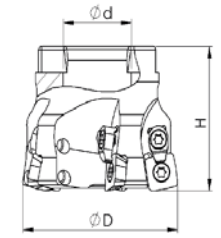
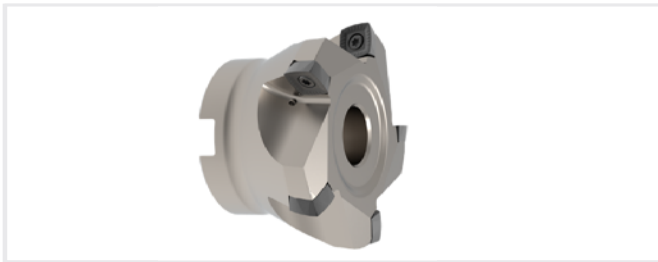

15°



Takım Kodu <i>Order Code</i>	Stok Durumu <i>Stock Availability</i>	D (mm)		H (mm)	d (mm)	Uç <i>Insert</i>	Vida <i>Screw</i>	Anahtar <i>Torx Key</i>
MCE052-03-SD12-C	○	52	3	40	22	SDMT1205...	M4X11.2	DT-TP10
MCE052-04-SD12-C	●	52	4	40	22			
MCE052-05-SD12-C	○	52	5	40	22			
MCE063-04-SD12-C	●	63	4	40	22			
MCE063-05-SD12-C	○	63	5	40	22			
MCE066-04-SD12-C	○	66	4	45	27			
MCE066-05-SD12-C	○	66	5	45	27			
MCE080-05-SD12-C	●	80	5	50	27			
MCE080-08-SD12-C	●	80	8	50	27			
MCE100-06-SD12-C	●	100	6	50	32			
MCE100-09-SD12-C	○	100	9	50	32			
MCE125-08-SD12-C	○	125	8	63	40			
MCE125-11-SD12-C	○	125	11	63	40			

FREZE KAFALARI / FACE MILLS

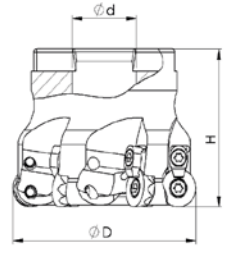

Takım Kodu Order Code	Stok Durumu Stock Availability	D (mm)		H (mm)	d (mm)	Uç Insert	Vida Screw	Anahtar Torx Key
MCE030-05-RP10-C	●	30	5	40	16	RPHX10T3...	M3X7.2	T09
MCE040-06-RP10-C	●	40	6	40	22		M3X7.2	T09

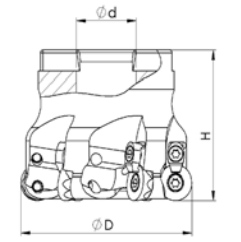

Takım Kodu Order Code	Stok Durumu Stock Availability	D (mm)		H (mm)	d (mm)	Uç Insert	Vida Screw	Anahtar Torx Key
MCE040-04-RP12-C	○	40	4	40	16	RPHX1204...	M4X8.5	T10
MCE050-05-RP12-C	●	50	5	40	22			
MCE063-06-RP12-C	●	63	6	40	22			
MCE080-07-RP12-C	○	80	7	50	27			

FREZE KAFALARI / FACE MILLS

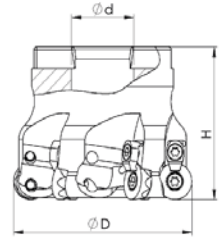
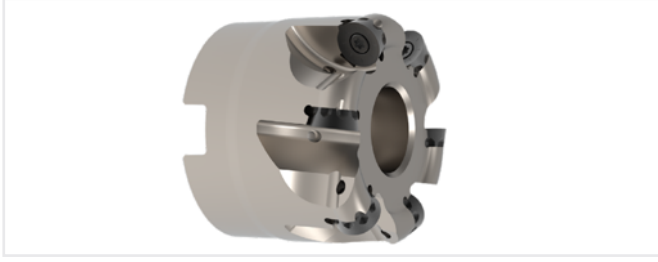

Takım Kodu Order Code	Stok Durumu Stock Availability	D (mm)		H (mm)	d (mm)			
MCE063-05-RP16-C	●	63	5	40	22			
MCE080-06-RP16-C	●	80	6	50	27	RPHX1605...	M5X12	T20
MCE100-07-RP16-C	●	100	7	50	32			

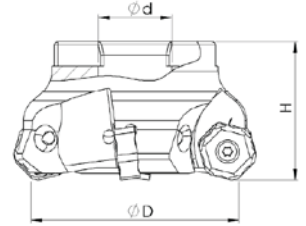
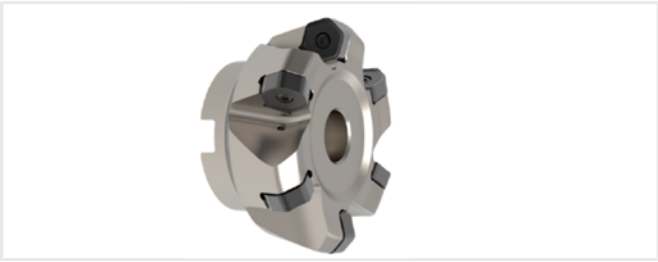

45°



Takım Kodu Order Code	Stok Durumu Stock Availability	D (mm)		H (mm)	d (mm)			
MCE063-04-HN09-C	○	63	4	40	22			
MCE063-05-HN09-C	○	63	5	40	22			
MCE080-05-HN09-C	○	80	5	50	27			
MCE080-06-HN09-C	○	80	6	50	27			
MCE100-06-HN09-C	○	100	6	50	32			
MCE100-08-HN09-C	○	100	8	50	32			
MCE100-10-HN09-C	○	100	10	50	32			
MCE125-06-HN09-C	○	125	6	63	40			
MCE125-10-HN09-C	○	125	10	63	40			
MCE125-12-HN09-C	○	125	12	63	40			
MCE160-08-HN09	△	160	8	63	40			
MCE160-12-HN09	△	160	12	63	40			

● Stok ürün - Stock item

○ Stok dışı ürün - Non Stock item

△ Özel Sipariş - Special order

FREZE KAFALARI / FACE MILLS

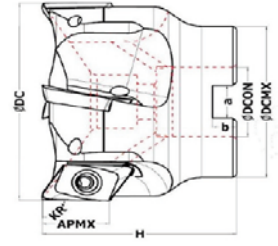

Takım Kodu Order Code	Stok Durumu Stock Availability	D (mm)		H (mm)	d (mm)	a	b	APMX			
MCK040-03-XE19-C	○	40	3	45	34	8.8	6	17	XEKT19...	SM4X10	T15
MCK050-04-XE19-C	○	50	4	50	42	9.6	6.3	17			
MCK063-04-XE19-C	○	63	4	50	48	10.3	6.3	17			
MCK080-05-XE19-C	○	80	5	50	57	12.3	7.3	17			
MCK100-06-XE19-C	○	100	6	52	70	12.3	8.3	17			
MCK125-07-XE19-C	○	125	7	54	87	16.3	9.3	17			

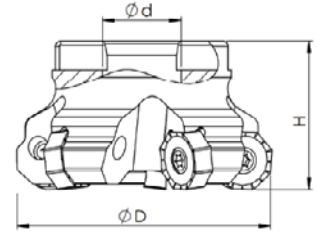
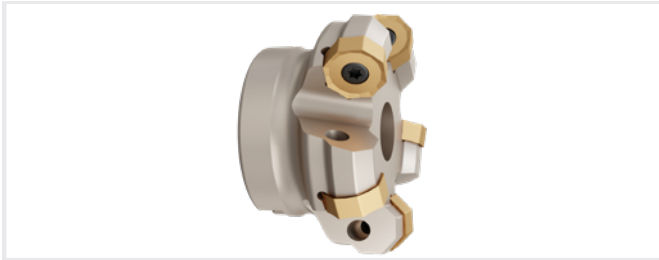

Takım Kodu Order Code	Stok Durumu Stock Availability	D (mm)		H (mm)	d (mm)			
MCZ063-05-ON06	●	63	5	40	22	ONHU0604...	M5X12	T20
MCZ080-07-ON06	●	80	7	50	27			
MCZ100-08-ON06	●	100	8	52	32			
MCZ125-09-ON06	●	125	9	62	40			

HELİSEL FREZELER/ HELICAL MILLING CUTTERS

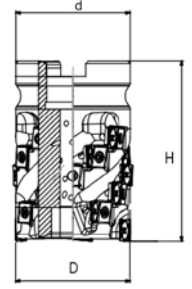

90°



Takım Kodu Order Code	Stok Durumu Stock Availability	D (mm)		H (mm)	d (mm)	Sıra Row	Toplam Uç Sayısı Total Insert	Uç Insert	Vida Screw	Anahtar Torx Key	Anahtar Installation Wrench
MCE040-03/12-LN09-C	○	40	3	55	16	4	12	LNHU0904..	M3X8.3	T09	A15/24
MCE040-03/15-LN09-C	○	40	3	65	16	5	15				
MCE050-03/24-LN09-C	○	50	4	75	22	6	24				

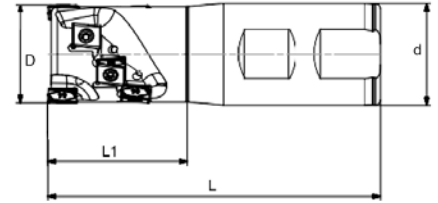
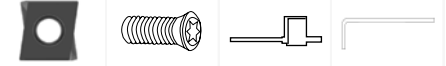

90°



Takım Kodu Order Code	Stok Durumu Stock Availability	D (mm)		L1 (mm)	L (mm)	d (mm)	Uç Insert	Sıra Row	Toplam Uç Sayısı Total Insert	APMX	Vida Screw	Anahtar Torx Key	Anahtar Installation Wrench				
MSE025-02/08-LN09-100-C	○	25	2	43	100	25	LNHU0904..	4	8	31	M3X8.3	T09	A15/24				
MSE032-02/08-LN09-105-C	○	32	2	44	105	32		5	10	39							
MSE032-02/10-LN09-110-C	○	32	2	50	110	32								15	46		
MSE040-03/15-LN09-125-C	○	40	3	55	125	40										6	18
MSE040-03/18-LN09-130-C	○	40	3	59	130	40											

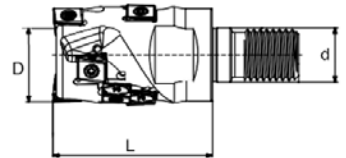

90°



Takım Kodu Order Code	Stok Durumu Stock Availability	D (mm)		L1 (mm)	L (mm)	d(mm)	M	Sıra Row	Toplam Uç Sayısı Total Insert	APMX	Uç Insert	Vida Screw	Anahtar Torx Key	Anahtar Installation Wrench
MTE025-02/06-LN09-C	○	25	2	40	64	12.5	M12	3	6	23	LNHU0904..	M3X8.3	T09	A15/24
MTE032-02/06-LN09-C	○	32	2	40	67	17	M16	3	6	23				
MTE032-02/08-LN09-C	○	32	2	50	77	17	M16	4	8	31				





● Stok ürün - Stock item

○ Stok dışı ürün - Non Stock item

△ Özel Sipariş - Special order

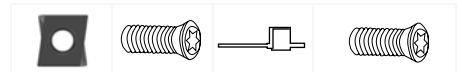
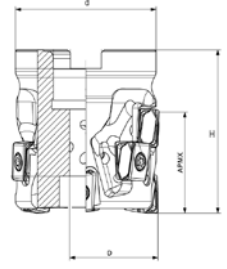
HELİSEL FREZELER/ HELICAL MILLING CUTTERS



Takım Kodu Order Code	Stok Durumu Stock Availability	D (mm)		H (mm)	d (mm)	Sıra Row	Toplam Uç Sayısı Total Insert	APMX	Uç Insert	Vida Screw	Anahtar Torx Key	Pabuç Vidası Clamping Screw
MCE040-02/06-LN13-C	○	40	2	55	16	3	6	34	LNHU1306..	M4X11.5	T15	M8X40
MCE040-02/08-LN13-C	○	40	2	65	16	4	8	45				M8X4.5
MCE050-03/09-LN13-C	○	50	3	55	22	3	9	34				M10X40
MCE050-03/12-LN13-C	○	50	3	65	22	4	12	45				M10X50
MCE063-04/20-LN13-C	○	63	4	80	27	5	20	56				M12X60
MCE063-04/16-LN13-C	○	63	4	70	27	4	16	45				M12X50
MCE080-05/25-LN13-C	○	80	5	85	32	5	25	56				M16X65

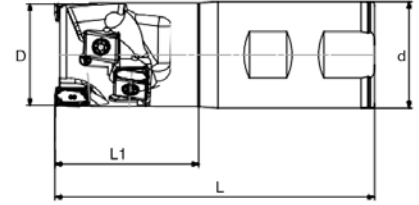

Takım Kodu Order Code	Stok Durumu Stock Availability	D (mm)		L1 (mm)	L (mm)	d (mm)	Sıra Row	Toplam Uç Sayısı Total Insert	APMX	Uç Insert	Vida Screw	Anahtar Torx Key
MSE040-02/06-LN13-120-C	○	40	2	54	120	40	3	6	34	LNHU1306..	M4X11.5	T15
MSE040-02/08-LN13-135-C	○	40	2	64	135	40	4	8	45			

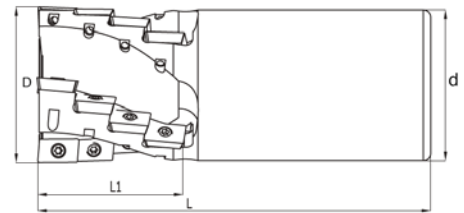

Takım Kodu Order Code	Stok Durumu Stock Availability	D (mm)		L (mm)	L1 (mm)	d (mm)	Uç Insert	Vida Screw	Anahtar Torx Key
MSG020-06-AP10-110-C	●	20	6	110	27	20	AP1003..	M2,5X7	T08
MSG025-08-AP10-120-C	●	25	8	120	36	25			
MSG032-15-AP10-120-C	●	32	15	120	45	32			
MSG040-18-AP10-130-C	●	40	18	130	54	32			

● Stok ürün - Stock item

○ Stok dışı ürün - Non Stock item

△ Özel Sipariş - Special order

HELİSEL FREZELER/ HELICAL MILLING CUTTERS

Önerilen kesme koşulları her zaman genel koşulları ifade eder. Bu kesme koşulları; makine rijitliği, kullanılan takım, iş parçasının bağlanma şekli ve soğutma sıvısına göre pratikte ayarlanmalıdır. Ortalama talaş kalınlığı (hm) = fz x sin(kr).

*The recommended cutting conditions always refer to general conditions. These cutting conditions should be adjusted according to the practical machine rigidity, tools, workpiece clamping and coolant. Average chip thickness (hm)=fz x sinkr.

Materyal/Materials				Kesme Derinliği ve İlerleme/Cutting depth and feed LNHU 0904..					
ISO	Malzeme Sınıflandırması Material classification	Çekme Dayanımı Tensile strength (N/mm ²)	Sertlik Hardness (HB)	ap		Talaş kırıcı/Chipbreaker			
						M4		R2	
				fz (mm)		fz (mm)			
				min	max	min	max	min	max
	Alaşımsız Çelik/Unalloyed steel	<600	<180	3.00	46.00	0.08	0.25	-	-
		<950	<280						
	Alaşımlı Çelik/Alloyed steel	700-950	200-280						
		950-1200	280-355						
		1200-1400	355-415						
	Dupleks Paslanmaz Çelik/Duplex stainless	778	230						
	Östenitik Paslanmaz Çelik/Austenitic stainless	675	200						
	Çökeltme Sertleşmeli Paslanmaz Çelik Precipitation-hardening stainless steel	1013	300						
	Gri Dökme Demir/Grey cast iron	700	220						
	Sfere Dökme Demir /Nodular cast iron	880	260						
	Temper Dökme Demir/Malleable cast iron	800	250						
	Alüminyum/Aluminum	260	75						
	Alüminyum Alaşım/Aluminum alloy	447	130						
	Demir Esaslı Alaşım/Fe-based alloy	943	280						
	Cobalt Esaslı Alaşım/Co-based alloy	1076	320						
	Nikel Esaslı Alaşım/Ni-based alloy	1177	350						
	Titanyum Esaslı Alaşım /Ti-alloy	1262	370						
	Sertleştirilmiş Çelik/Hardened steel	-	50-60HRC						
	Beyaz Dökme Demir/Chilled cast iron	-	55HRC						

Materyal/Materials				Kesme Derinliği ve İlerleme/Cutting depth and feed LNHU 0904..					
ISO	Malzeme Sınıflandırması Material classification	Çekme Dayanımı Tensile strength (N/mm ²)	Sertlik Hardness (HB)	ap		Talaş kırıcı/Chipbreaker			
						M4		R2	
				fz (mm)		fz (mm)			
				min	max	min	max	min	max
	Alaşımsız Çelik/Unalloyed steel	<600	<180	3.00	46.00	0.08	0.25	0.08	0.28
		<950	<280						
	Alaşımlı Çelik/Alloyed steel	700-950	200-280						
		950-1200	280-355						
		1200-1400	355-415						
	Dupleks Paslanmaz Çelik/Duplex stainless	778	230						
	Östenitik Paslanmaz Çelik/Austenitic stainless	675	200						
	Çökeltme Sertleşmeli Paslanmaz Çelik Precipitation-hardening stainless steel	1013	300						
	Gri Dökme Demir/Grey cast iron	700	220						
	Sfere Dökme Demir /Nodular cast iron	880	260						
	Temper Dökme Demir/Malleable cast iron	800	250						
	Alüminyum/Aluminum	260	75						
	Alüminyum Alaşım/Aluminum alloy	447	130						
	Demir Esaslı Alaşım/Fe-based alloy	943	280						
	Cobalt Esaslı Alaşım/Co-based alloy	1076	320						
	Nikel Esaslı Alaşım/Ni-based alloy	1177	350						
	Titanyum Esaslı Alaşım /Ti-alloy	1262	370						
	Sertleştirilmiş Çelik/Hardened steel	-	50-60HRC						
	Beyaz Dökme Demir/Chilled cast iron	-	55HRC						

VİDALI TAKIMLAR / SCREW TYPE ENDMILLS

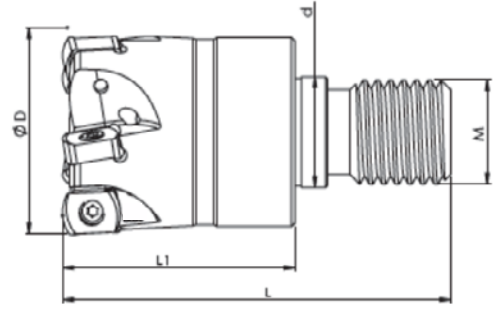

90°



Takım Kodu Order Code	Stok Durumu Stock Availability	D (mm)		L1 (mm)	L (mm)	d (mm)	M (mm)			
MTY020-03-LN03-M10-C	●	20	3	36	60	10,5	M10	LNGX0303...	SM3X8	T08
MTY025-04-LN03-M12-C	●	25	4	36	60	12,5	M12			
MTY032-05-LN03-M16-C	●	32	5	38	62	17	M16			
MTY035-05-LN03-M16-C	●	35	5	38	62	17	M16			
MTY040-06-LN03-M16-C	●	40	6	40	65	17	M16			
MTY042-06-LN03-M16-C	●	42	6	40	65	17	M16			

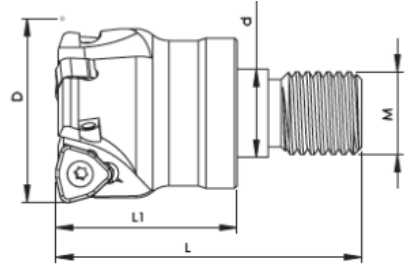

14°



Takım Kodu Order Code	Stok Durumu Stock Availability	D (mm)		L1 (mm)	L (mm)	d (mm)	M (mm)			
MTK025-02-W N09-M12-C	●	25	2	28	50	12,5	M12	WNGX09T3...	SM3X10	T10
MTK032-03-W N09-M16-C	●	32	3	38	60	17	M16			
MTK035-04-W N09-M16-C	●	35	4	38	60	17	M16			
MTK040-04-W N09-M16-C	●	40	4	38	60	17	M16			
MTK042-04-W N09-M16-C	●	42	4	36	60	17	M16			

● Stok ürün - Stock item

○ Stok dışı ürün - Non Stock item

△ Özel Sipariş - Special order

VİDALI TAKIMLAR / SCREW TYPE ENDMILLS

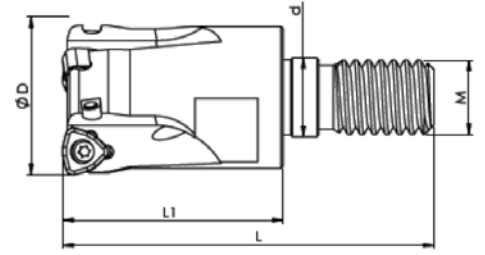

14°



Takım Kodu Order Code	Stok Durumu Stock Availability	D (mm)		L1 (mm)	L (mm)	d (mm)	M (mm)				
MTK016-02-W N06-M08	●	16	2	25	42	8,5	M8	W NGX0603...			
MTK020-03-W N06-M10	●	20	3	35	60	10,5	M10				
MTK025-03-W N06-M12	●	25	3	35	60	12,5	M12				
MTK025-04-W N06-M12	●	25	4	35	60	12,5	M12				
MTK032-05-W N06-M16	●	32	5	35	60	17	M16				
MTK035-05-W N06-M16	●	35	5	35	60	17	M16				

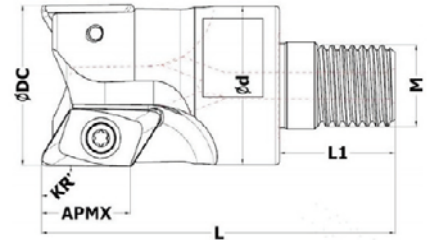

90°



Takım Kodu Order Code	Stok Durumu Stock Availability	D (mm)		L1 (mm)	L (mm)	d (mm)	M (mm)	APMX			
MTK025-02-XE19-M12-C	○	25	2	22	68	23	M12	17	XEKT19...		
MTK032-02-XE19-M16-C	○	32	2	23	70	31	M16	17			
MTK040-03-XE19-M16-C	○	40	3	23	72	32	M16	17			

● Stok ürün - Stock item

○ Stok dışı ürün - Non Stock item

△ Özel Sipariş - Special order

VİDALI TAKIMLAR / SCREW TYPE ENDMILLS

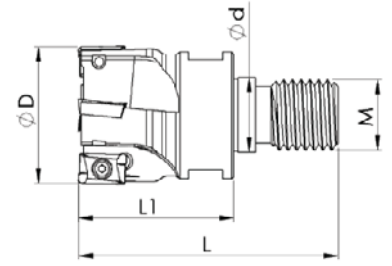
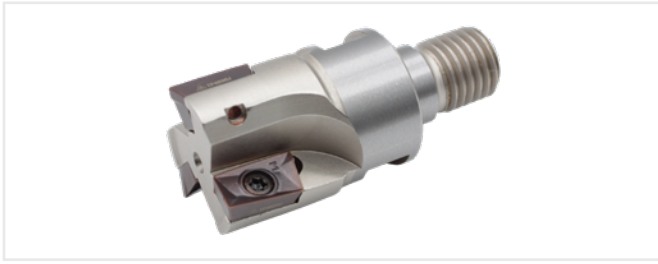

90°



Takım Kodu Order Code	Stok Durumu Stock Availability	D (mm)		L1 (mm)	L (mm)	d (mm)	M (mm)		Uç Insert	Vida Screw	Anahtar Torx Key
MTG016-02-AP10-M08-C	●	16	2	33	50	8,5	M08		APKT1003...	M2,5X7	T06
MTG020-03-AP10-M10-C	●	20	3	32	51	10,5	M10				
MTG025-03-AP10-M12-C	●	25	3	38	60	12,5	M12				
MTG032-04-AP10-M16-C	●	32	4	36	60	17	M16				
MTG035-04-AP10-M16-C	●	35	4	36	60	17	M16				
MTG040-05-AP10-M16-C	●	40	5	36	60	17	M16				
MTG025-02-AP16-M12-C	●	25	2	38	60	12,5	M12		APKT1604...	M3,5X8	T15
MTG032-03-AP16-M16-C	●	32	3	44	68	17	M16				
MTG040-04-AP16-M16	●	40	4	44	68	17	M16				

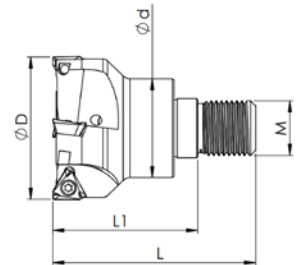

90°



Takım Kodu Order Code	Stok Durumu Stock Availability	D (mm)		L1 (mm)	L (mm)	d (mm)	M (mm)		Uç Insert	Vida Screw	Anahtar Torx Key
MTT032-04-3PKT10-M16	●	32	4	36	60	17	M16		3PKT1004...	M3X8	T10
MTT042-04-3PKT10-M16	●	42	4	36	60	17	M16				

● Stok ürün - Stock item

○ Stok dışı ürün - Non Stock item

▲ Özel Sipariş - Special order

VİDALI TAKIMLAR / SCREW TYPE ENDMILLS

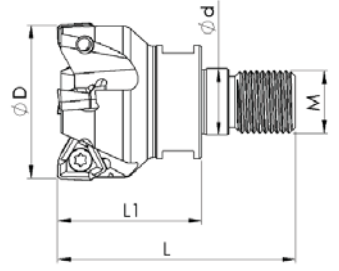

90°



Takım Kodu Order Code	Stok Durumu Stock Availability	D (mm)		L1 (mm)	L (mm)	d (mm)	M (mm)			
MTT021-03-SN06-M10-C	●	21	3	31	50	17	M10			
MTT026-03-SN06-M12-C	●	26	3	28	50	12,5	M12	SNKT0603...	M3X8	T10
MTT032-04-SN06-M16-C	●	32	4	36	60	17	M16			

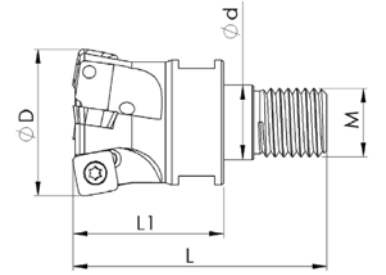





10°



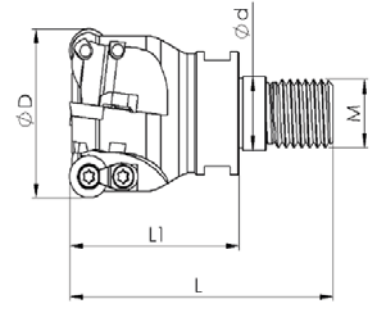



Takım Kodu Order Code	Stok Durumu Stock Availability	D (mm)		L1 (mm)	L (mm)	d (mm)	M (mm)			
MTZ025-02-SD09-M12-C	●	25	2	28	50	12,5	M12			
MTZ025-03-SD09-M12-C	●	25	3	28	50	12,5	M12			
MTZ032-03-SD09-M16-C	●	32	3	36	60	17	M16			
MTZ035-04-SD09-M16-C	●	35	4	36	60	17	M16			
MTZ040-04-SD09-M16-C	●	40	4	36	60	17	M16			
MTZ042-04-SD09-M16-C	●	42	4	36	60	17	M16	SDMT09T3...	M3,5X8	T15

VİDALI TAKIMLAR / SCREW TYPE ENDMILLS

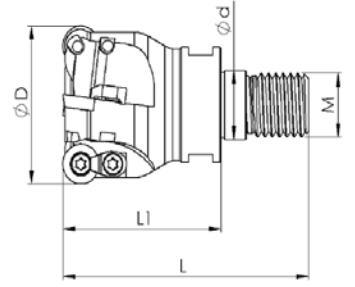

Takım Kodu Order Code	Stok Durumu Stock Availability	D (mm)		L1 (mm)	L (mm)	d (mm)	M (mm)	 Uç Insert	 Vida Screw	 Anahtar Torx Key
MTE015-03-RP10-M12-C	○	15	3	35	57	12.5	M12	RPHX10T3...	M3X7.2	T09
MTE022-04-RP10-M16-C	○	22	4	43	67	17	M16			



Takım Kodu Order Code	Stok Durumu Stock Availability	D (mm)		L1 (mm)	L (mm)	d (mm)	M (mm)	 Uç Insert	 Vida Screw	 Anahtar Torx Key
MTE040-04-RP12-M16-C	○	40	4	43	67	17	M16	RPHX1204...	M4X8.5	T10

Screw-on Arbor



Takım Kodu Order Code	Stok Durumu Stock Availability	D (mm)	d (mm)	M (mm)	L (mm)	l (mm)
ET D15 C16 M08 L120-H	●	15	16	8	120	40
ET D18 C20 M10 L120-H	●	18	20	10	120	60
ET D18 C20 M10 L170-H	●	18	20	10	170	90
ET D24 C25 M12 L160-H	●	24	25	12	160	80
ET D24 C25 M12 L200-H	●	24	25	12	200	100
ET D24 C25 M12 L250-H	●	24	25	12	250	150
ET D31 C32 M16 L160-H	●	31	32	16	160	80
ET D31 C32 M16 L200-H	●	31	32	16	200	100
ET D31 C32 M16 L250-H	●	31	32	16	250	150

● Stok ürün - Stock item

○ Stok dışı ürün - Non Stock item

△ Özel Sipariş - Special order

Engineered for Excellence.

#EuroloyExcellence



Italy Office



Via Leonardo Da Vinci, 4 – 20054
Milano MI ITALIA



(+39) 0282398309



info@euroloy.com

Turkey Office



Üsküdar Cad. YEDPA No:1
Ataşehir -İstanbul -TÜRKİYE



(+90) 850 933 3408



euroloytr@euroloy.com



euroloytools



Euroloy Cutting Tools