

MILLING

2026 | CATALOG

www.euroloy.com

EUROLOY
CARBIDE TOOLS



TABLE OF

Contents

Milling Insert Coding	D3
Milling Grades	D5
Milling Inserts	D7
Milling Tools Summary	D11
Indexable Endmills	D15
Face Mills	D34
Helical Milling Cutters	D53
Screw Type Endmills	D56

S

P

K

R

12

1

2

3

4

5

Insert Shape

Relief Angle

Tolerance

Cutting Insert Type

Cutting Edge Length

1 Insert Shape

S P K R 12 03 ED08 S R - NN

A C D H L O
R S T V W

2 Relief Angle

S P K R 12 03 ED08 S R - NN

A B C D E
F G N P

3 Tolerance

S P K R 12 03 ED08 S R - NN

d: Inscribed circle diameter
t: Thickness
m: Fig. in the Picture

Tolerance on C,E,H,M,O,P,R,S,T,W Insert Shape (Exceptional Case)

Class	(mm)		
	d	m	t
A	±0.025	±0.005	±0.025
C	±0.025	±0.013	±0.025
H	±0.013	±0.013	±0.025
E	±0.025	±0.025	±0.025
G	±0.025	±0.025	±0.13
J	±0.05-±0.15	±0.005	±0.025
K	±0.05-±0.15	±0.013	±0.025
L	±0.05-±0.15	±0.025	±0.025
M	±0.05-±0.15	±0.08-±0.20	±0.13
U	±0.08-±0.25	±0.13-±0.38	±0.13

Tolerance on D Insert Shape (Exceptional Case)

d	Tolerance d		Tolerance m	
	J,K,L,M,N	U	M,N	U
6.35	±0.05	±0.08	±0.08	±0.13
9.525	±0.05	±0.08	±0.08	±0.13
12.7	±0.08	±0.13	±0.13	±0.20
15.875	±0.10	±0.18	±0.15	±0.27
19.05	±0.10	±0.18	±0.15	±0.27
25.4	±0.13	±0.25	±0.18	±0.38

d	Tolerance d		Tolerance m	
	J,K,L,M,N	U	M,N	U
6.35	±0.05	±0.11		
9.525	±0.05	±0.11		
12.7	±0.08	±0.15		
15.875	±0.10	±0.18		
19.05	±0.10	±0.18		

4 Cutting Insert Type

S P K R 12 03 ED08 S R - NN

A B C F
G H J M
N Q R T
U W X

Chamfer 70°-90° Chamfer 70°-90°
Chamfer 70°-90° Chamfer 70°-90°
Chamfer 40°-60° Chamfer 40°-60°
Special Type
Chamfer 40°-60° Chamfer 40°-60°

5 Cutting Edge Length

S P K R 12 03 ED08 S R - NN

Metric System

Inch System

The value to be used for cutting inserts with an inscribed circle smaller than 1/4" (1/32" to 1/4").

The value to be used for cutting inserts with an inscribed circle larger than 1/4" (1/8" to 1/4").

* In addition to round inserts, equilateral quadrilateral and rectangular cutting inserts provide a longer cutting edge.

Table According To The "Metric" and "Inch" Systems

Symbol	6	9	11	16	22	27	33	44
△								
□	3	5	6	9	12	15	19	25
▱	4	6	7	11	15	19	23	31
⊠	3	5	6	9	12	16	19	25
Internal tangent diameter	5/32"	7/32"	1/4"	3/8"	1/2"	5/8"	3/4"	1"
Inch System	5	7	2 (B)	3	4	5	6	8

Milling

03

6

Height of Cutting Edge

ED 08

7

Nose Radius (Nose R)

S

8

Edge Shape

R

9

Cutting Direction

NN

10

Chip Breaker for Milling

6 Height of Cutting Edge

S P K R 12 **03** ED 08 S R - NN

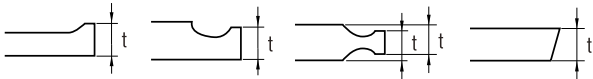

Symbol		Cutting edge thickness (t)	
Metric	Inch	mm	Inch
01	1 (2)	1.59	1/16
T0	1.125	1.79	9/128
T1	1.2	1.98	5/64
02	1.5 (3)	2.38	3/32
T2	1.75	2.78	7/64
03	2	3.18	1/8
T3	2.5	3.97	5/32
04	3	4.76	3/16
05	3.5	5.56	7/32
06	4	6.35	1/4
07	5	7.94	5/16
09	6	9.52	3/8
11	7	11.11	7/16
12	8 (16)	12.70	1/2

symbols for small size inserts

8 Edge Shape

S P K R 12 03 ED 08 **S** R - NN

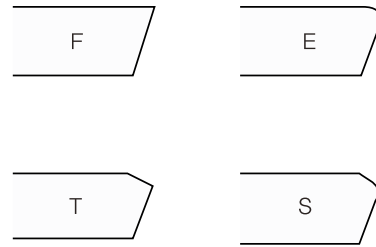

9 Cutting Direction

S P K R 12 03 ED 08 S **R** - NN

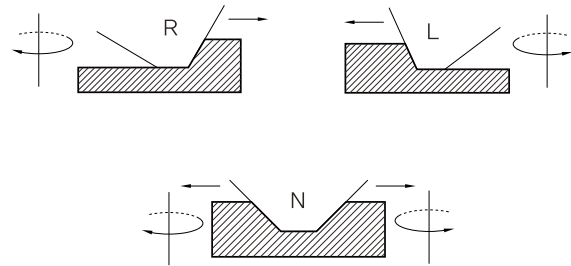

7 Nose Radius

S P K R 12 03 ED **08** S R - NN

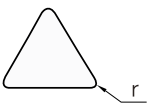

r		Symbol		r		Symbol	
mm	Inch	mm	Inch	mm	Inch	mm	Inch
00	0	0.0		12	3	1.2	3/64
02		0.2		15		1.5	
04	1	0.4	1/64	16	4	1.6	4/64
05		0.5		24	6	2.4	6/64
08	2	0.8	2/64	32	8	3.2	8/64
10		1.0		40		4.0	

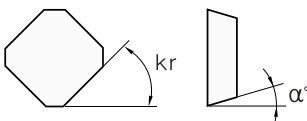

Parallel surface		Relief Angle	
kr		α°	
A - 45°		A - 3°	F - 25°
D - 60°		B - 5°	G - 30°
E - 75°		C - 7°	N - 0°
F - 85°		D - 15°	P - 11°
P - 90°			
Z - Special			

10 Chip Breaker for Milling

S P K R 12 03 ED 08 S R - **NN**



Milling

MILLING GRADES

Grade	ISO	Coating	Stock availability	Features
TC0135	P35	CVD	△	CVD coated grade for high speed milling of steel. It combines good wear resistance and toughness to avoid chipping and edge breakage. Can be used in both wet and dry conditions.
TC0140	P40	CVD	△	Suitable for large depth of cut, medium to high speed milling of steel under unstable cutting conditions.
TC2215	K15	CVD	●	CVD coated grade for high speed milling of cast iron. Suitable for higher cutting parameters and ensures stable performance and reliability. Can be used from finish, semi-finish to rough milling.
TC2225	K25	CVD	○	Suitable for semi-finish milling and rough milling of gray cast iron at medium and high cutting speed. Recommended for dry cutting conditions to achieve longer tool life.
TP2125	P25 M25	PVD	●	First choice for steel milling. It is recommended to be used in rough to finish machining of steel under stable working conditions, good for both dry and wet machining with small cutting width, complex tool path and adhesive materials.
TP2135	P35 M35	PVD	○	Supplementary grade to TP2125 with medium hardness substrate when high toughness is required.
TP2335	M35	PVD	○	Suitable for milling stainless steel and steel at medium and low speed under unstable machining conditions.
TP2345	P35 M35	PVD	○	Ultra-thick PVD coated grade is the first choice for stainless steel milling. It is suitable for rough milling of stainless steel under unstable machining conditions.
TP2225	K25	PVD	○	Suitable for semi-finish and rough milling of gray cast iron and nodular cast iron at medium and low cutting speed. Has excellent tool life under both dry and wet conditions.

● Stock item

○ Non Stock item

△ Special order

MILLING GRADES

Grade	ISO	Coating	Stock availability	Features
TP4415	S15	PVD	●	Carbide substrate has both toughness and high hot hardness characteristics and is suitable for rough milling of stainless steel under unstable machining conditions. Milling at low cutting speed can achieve longer tool life.
TP4405	H15	PVD	△	Produced-per-order grade, suitable for milling hardened steel. Can be used in rough and finish milling, Milling the needs of most conditions.
TP2620	P20 M20 K20 S15 H15	PVD	●	Universal grade with excellent wear resistance and stability. Suitable for milling of steel, stainless steel and cast iron. Also applicable for semi-finishing of superalloys and semi-finish milling of HRC45-55 hardened materials.
TP2630 TP4630	P30 M30 K40 S25 H25	PVD	●	Universal grade applicable for rough, semi-finish and light interrupted milling of steel and stainless steel.
TP2640	P45 M45 K45 S25 H25	PVD	△	Supplementary grade to TP2630 when high toughness is required.
TP2320 TP1320	P20 M20	PVD	●	Submicron grade with excellent wear resistance and toughness, first choice for continuous milling of stainless steel. Also works well for general machining of steel.
TN7501	N15	-	●	Uncoated grade combined with sharp cutting edge, used in aluminum alloy milling.

Milling

● Stock item

○ Non Stock item

△ Special order

MILLING TOOLS SUMMARY

Type	Picture	Code	Approach Angle	Diameter Range	Insert	Feature	Page
INDEXABLE ENDMILLS		MSG...	90°	Ø12-40 mm	APKT 10...		D15
		MSZ...	90°	Ø16-32 mm	APKT 11T3...		D18
		MSZ...	90°	Ø25-33 mm	APKT 16...		D19
		MST...	90°	Ø20-32 mm	3PKT 10...		D19
		MST...	90°	Ø16-33 mm	BLXP 06...		D20
		MSW...	-	Ø 8-32 mm	RCE...		D20
		MSY...	90°	Ø16-33 mm	LNGX 03...		D21
		MSK...	90°	Ø16-40 mm	LNMX 10...		D22
		MSG...	90°	Ø35-50 mm	TPKN 16...		D22
		MSG...	-	Ø16-40 mm	RD... 0803 RD... 1003 RD... 10T3 RD... 1204		D23
		MSG...	45°-60°	Ø15-40 mm	TCMT 11... TCMT 16...		D24
		MSK...	14°	Ø25-32 mm	WNGX 09...		D24
		MSS...	90°	Ø16-25 mm	R390 11...		D25
		MSE...	90°	Ø25-40 mm	APKT 17...		D25
		MST...	90°	Ø16-26 mm	SNKT 06...		D26
		MST...	90°	Ø25-32 mm	6NGU 06...		D26
		MST...	90°	Ø32 mm	3PKT 15...		D27
		MSY...	90°	Ø10-16 mm	LPGU 0102...		D27
		MSZ...	10°	Ø22-42 mm	SDMT 09...		D28
		MSE...	90°	Ø40 mm	LNHU 13...		D28
	MSE...	90°	Ø20-33 mm	LNHU 09...		D29	
	MSE...	45°	Ø40 mm	XNMU 07...		D29	
	MSE...	15°	Ø25-32 mm	SDMT 09...		D30	

Type	Picture	Code	Approach Angle	Diameter Range	Insert	Feature	Page
INDEXABLE ENDMILLS		MSE...	15°	Ø25-32 mm	SDMT 09...		D30
		MSE...	15°	Ø32 mm	SDMT 12...		D30
		MSE...	-	Ø15-22 mm	RPHX 10T...		D31
		MSE...	-	Ø32 mm	RPHX 12...		D31
		MSK...	90°	Ø20-40 mm	XEKT 19...		D32
		MSK...	14°	Ø25-32 mm	W NGX 09T3...		D32
		MSU...	90°	Ø16-33 mm			D33
MILLING HEADS		MCG...	90°	Ø40-100 mm	APKT 10...		D34
		MCY...	90°	Ø40-52 mm	LNGX 03...		D34
		MCT...	90°	Ø40-63 mm	BLXP 06...		D35
		MCG...	90°	Ø40-80 mm	APKT 11... APKT 16...		D35
		MCK...	90°	Ø40-50 mm	LNMX 1006...		D36
		MCK...	90°	Ø50-160 mm	LNMX 1510...		D36
		MCU...	90°	Ø40-63 mm	LNET 03...		D36
		MCG...	-	Ø40-160 mm	RD... 1003... RD... 10T3... RD... 12T3... RD... 1604...		D37
		MCK...	45°	Ø50-160 mm	SNMX 1205...		D38
		MCK...	88°	Ø50-250 mm	SNMX 1206... SNMX1205...		D38
		MCG...	90°	Ø50-100 mm	TPKN 16...		D39
		MCG...	90°	Ø63-250 mm	TPKN 22...		D39
		MCY...	90°	Ø50-250 mm	W NMU 0806...		D40
		MCK...	14°	Ø40-66 mm	W NGX 09T3...		D39
		MCT...	90°	Ø50-100 mm	3PKT 15...		D41
		MCT...	90°	Ø40-63 mm	3PKT 10...		D41

Type	Picture	Code	Approach Angle	Diameter Range	Insert	Feature	Page
MILLING HEADS		MCT...	90°	Ø40-63 mm	6NGU 06...		D41
		MCT...	90°	Ø50-125 mm	6NGU 09...		D41
		MCS...	90°	Ø40-63 mm	R390 11...		D42
		MCZ...	10°	Ø40-100 mm	SDMT 09...		D42
		MCT...	90°	Ø40-63 mm	BLXP 09...		D43
		MCW ...	90°	Ø50-63 mm	SPMT 12...		D43
		MCG...	75°	Ø63-200 mm	SPKN 12...		D44
		MCZ...	45°	Ø50-160 mm	ONHU 08...		D44
		MCE...	40°	Ø50-160 mm	ODMT 06...		D45
		MCE...	90°	Ø50-100 mm	APKT 17...		D45
		MCE...	45°	Ø40-200 mm	XNMU 07...		D46
		MCE...	45°	Ø63-315 mm	XNMU 09...		D46
		MCE...	90°	Ø40-80 mm	LNHU 09...		D47
		MCE...	90°	Ø63-160 mm	LNHU 16...		D47
		MCE...	90°	Ø40-250 mm	LNHU 13...		D48
		MCE...	15°	Ø40-50 mm	SDMT 09...		D49
		MCE...	15°	Ø52-125 mm	SDMT 12...		D49
		MCE...	-	Ø30-40 mm	RPHX 10T...		D50
		MCE...	-	Ø40-80 mm	RPHX 12...		D50
		MCE...	-	Ø63-100 mm	RPHX 16...		D51
		MCE...	45°	Ø63-160 mm	HNGX 09...		D51
		MCK...	90°	Ø40-125 mm	XEKT 19...		D52

Type	Picture	Code	Approach Angle	Diameter Range	Insert	Feature	Page
HELICAL MILLING CUTTERS		MCZ...	45°	Ø 63-125 mm	ONHU 06...		D52
		MCE...	90°	Ø 40-50 mm	LNHU 09...		D53
		MCE...	90°	Ø 25-40 mm	LNHU 09...		D53
		MTE...	90°	Ø 25-32 mm	LNHU 09...		D53
		MCE...	90°	Ø 40-80 mm	LNHU 13...		D54
		MSE...	90°	Ø 40 mm	LNHU 13...		D54
		MSG...	90°	Ø 40-80 mm	APKT 10...		D54
SCREW TOOLS		MTT...	90°	Ø 20-42 mm	BLXP 06...		D56
		MTY...	90°	Ø 20-42 mm	LNGX 03...		D57
		MTU...	90°	Ø 20-42 mm	LNEX 03...		D57
		MTK...	14°	Ø 25-40 mm	WNGX 09T3...		D57
		MTK...	14°	Ø 16-35 mm	WNGX 0603...		D58
		MTK...	90°	Ø 25-40 mm	XEKT 19...		D58
		MTG...	90°	Ø 16-40 mm	APKT 10...		D59
		MTG...	90°	Ø 25-40 mm	APKT 16...		D59
		MTT...	90°	Ø 32-42 mm	3PKT 10...		D59
		MTT...	90°	Ø 21-32 mm	SNKT 06...		D60
		MTZ...	15°	Ø 25-42 mm	SDMT 09...		D60
		MTE...	-	Ø 15-22 mm	RPHX 10T...		D61
		MTE...	-	Ø 40mm	RPHX 12...		D61

Milling

INDEXABLE ENDMILLS

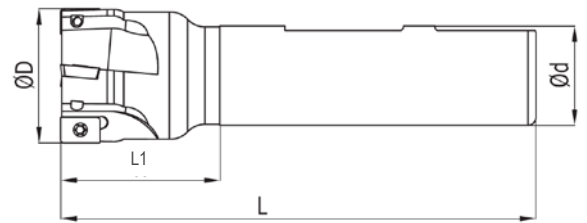

90°



Order Code	Stock Availability	D (mm)		L1 (mm)	L (mm)	d (mm)	Insert	Screw	Torx Key
MSG012-01-AP10-120	●	12	1	40	120	12	APKT1003...	SM2,5X6	T08
MSG012-01-AP10-120-C	●	12	1	40	120	12			
MSG014-01-AP10-120	●	14	1	30	120	12			
MSG016-02-AP10-100	●	16	2	35	100	16			
MSG016-02-AP10-100-C	●	16	2	35	100	16			
MSG016-02-AP10-120	●	16	2	40	120	16			
MSG016-02-AP10-120-C	●	16	2	40	120	16			
MSG016-02-AP10-150	●	16	2	50	150	16			
MSG016-02-AP10-150-C	●	16	2	50	150	16			
MSG016-02-AP10-200	●	16	2	50	200	16			
MSG016-02-AP10-200-C	●	16	2	50	200	16			
MSG016-02-AP10-250	●	16	2	60	250	16			
MSG018-02-AP10-100	●	18	2	30	100	16			
MSG018-02-AP10-100-C	●	18	2	30	100	16			
MSG018-02-AP10-120	●	18	2	30	120	16			
MSG018-02-AP10-120-C	●	18	2	30	120	16			
MSG018-02-AP10-150	●	18	2	30	150	16			
MSG018-02-AP10-150-C	●	18	2	30	150	16			
MSG018-02-AP10-200	●	18	2	30	200	16			
MSG018-02-AP10-200-C	●	18	2	30	200	16			
MSG020-03-AP10-100	●	20	3	30	100	20	APKT1003...	SM2,5X7	T08
MSG020-03-AP10-100-C	●	20	3	30	100	20			
MSG020-03-AP10-120	●	20	3	40	120	20			
MSG020-03-AP10-120-C	●	20	3	40	120	20			
MSG020-03-AP10-150	●	20	3	50	150	20			
MSG020-03-AP10-150-C	●	20	3	50	150	20			
MSG020-03-AP10-200	●	20	3	60	200	20			
MSG020-03-AP10-200-C	●	20	3	60	200	20			

● Stock item

○ Non Stock item

△ Special order

INDEXABLE ENDMILLS

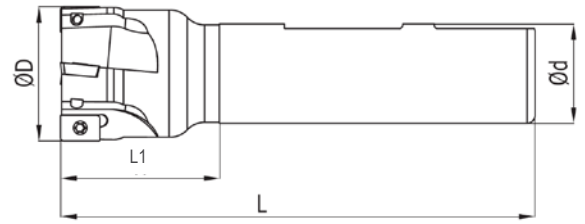

90°



Order Code	Stock Availability	D (mm)		L1 (mm)	L (mm)	d (mm)	Insert	Screw	Torx Key
MSG020-03-AP10-200-C	●	20	3	60	200	20			
MSG020-03-AP10-250	●	20	3	60	250	20			
MSG022-03-AP10-100	●	22	3	30	100	20			
MSG022-03-AP10-100-C	●	22	3	30	100	20			
MSG022-03-AP10-120	●	22	3	30	120	20			
MSG022-03-AP10-120-C	●	22	3	30	120	20	APKT1003...	SM2,5X7	T08
MSG022-03-AP10-150	●	22	3	30	150	20			
MSG022-03-AP10-150-C	●	22	3	30	150	20			
MSG022-03-AP10-200	●	22	3	30	200	20			
MSG022-03-AP10-250	●	22	3	30	250	20			
MSG025-03-AP10-100	●	25	3	35	100	25			
MSG025-03-AP10-100-C	●	25	3	35	100	25			
MSG025-03-AP10-120-C	●	25	3	40	120	25			
MSG025-03-AP10-150	●	25	3	50	150	25			
MSG025-03-AP10-150-C	●	25	3	50	150	25			
MSG025-03-AP10-200	●	25	3	60	200	25			
MSG025-03-AP10-200-C	●	25	3	60	200	25			
MSG025-03-AP10-250	●	25	3	60	250	25			
MSG026-03-AP10-150	●	26	3	30	150	25	APKT1003...	SM2,5X7	T08
MSG026-03-AP10-200	●	26	3	30	200	25			
MSG026-03-AP10-250	●	26	3	30	250	25			
MSG028-04-AP10-150	●	28	4	30	150	25			
MSG028-04-AP10-150-C	●	28	4	30	150	25			
MSG030-04-AP10-100	●	30	4	30	100	25			
MSG030-04-AP10-100-C	●	30	4	30	100	25			
MSG030-04-AP10-120	●	30	4	30	120	25			
MSG030-04-AP10-120-C	●	30	4	30	120	25			
MSG030-04-AP10-150	●	30	4	40	150	25			

● Stock item

○ Non Stock item

▲ Special order

INDEXABLE ENDMILLS

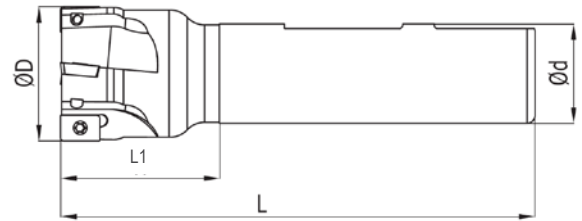

90°

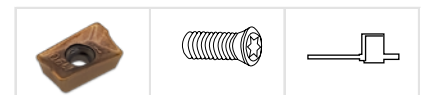

Order Code	Stock Availability	D (mm)		L1 (mm)	L (mm)	d (mm)	Insert	Screw	Torx Key
MSG030-04-AP10-150-C	●	30	4	40	150	25	APKT1003...	SM2,5X7	T08
MSG030-04-AP10-200	●	30	4	40	200	25			
MSG030-04-AP10-200-C	●	30	4	40	200	25			
MSG030-04-AP10-300	●	30	4	40	300	25			
MSG032-04-AP10-150	●	32	4	40	150	25			
MSG032-04-AP10-150-C	●	32	4	60	150	32			
MSG032-04-AP10-200	●	32	4	60	200	32			
MSG032-04-AP10-200-C	●	32	4	60	200	32			
MSG035-04-AP10-100	●	35	4	30	100	32			
MSG035-04-AP10-100-C	●	35	4	30	100	32			
MSG035-04-AP10-120	●	35	4	30	120	32			
MSG035-04-AP10-120-C	●	35	4	30	120	32			
MSG035-04-AP10-150	●	35	4	30	150	32			
MSG035-04-AP10-150-C	●	35	4	30	150	32			
MSG035-04-AP10-200	●	35	4	30	200	32			
MSG040-04-AP10-100	●	40	4	40	100	32			
MSG040-05-AP10-100-C	●	40	5	40	100	32			
MSG040-05-AP10-120	●	40	5	40	120	32			
MSG040-05-AP10-120-C	●	40	5	40	120	32			
MSG040-05-AP10-150	●	40	5	40	150	32			
MSG040-05-AP10-150-C	●	40	5	40	150	32			
MSG040-05-AP10-200	●	40	5	40	200	32			
MSG040-05-AP10-200-C	●	40	5	40	200	32			

Milling

● Stock item

○ Non Stock item

△ Special order

INDEXABLE ENDMILLS

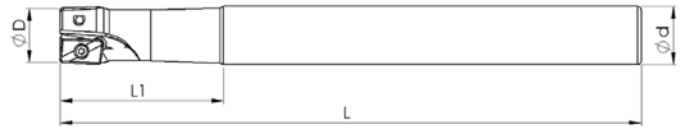

90°



Order Code	Stock Availability	D (mm)		L1 (mm)	L (mm)	d (mm)	Insert	Screw	Torx Key
MSZ016-02-AP11-100	●	16	2	30	100	16	APKT11T3...	SM2,5X6	T08
MSZ016-02-AP11-160	●	16	2	30	160	16			
MSZ016-02-AP11-160-C	●	16	2	30	160	16			
MSZ016-02-AP11-200	●	16	2	30	200	16			
MSZ016-02-AP11-200-C	●	16	2	30	200	16			
MSZ017-02-AP11-160	●	17	2	30	160	16			
MSZ017-02-AP11-200	●	17	2	30	200	16			
MSZ017-02-AP11-250	●	17	2	30	250	16			
MSZ018-02-AP11-160	●	18	2	30	160	16			
MSZ020-03-AP11-120	●	20	3	30	120	20			
MSZ020-03-AP11-160	●	20	3	30	160	20			
MSZ020-03-AP11-160-C	●	20	3	40	160	20			
MSZ020-03-AP11-200	●	20	3	40	200	20			
MSZ021-03-AP11-160	●	21	3	40	160	20			
MSZ021-03-AP11-200	●	21	3	40	200	20			
MSZ022-03-AP11-250	●	22	3	40	250	20			
MSZ025-03-AP11-120	●	25	3	40	120	25			
MSZ025-03-AP11-160	●	25	3	40	160	25			
MSZ025-03-AP11-200	●	25	3	40	200	25			
MSZ026-03-AP11-160	●	26	3	50	160	25			
MSZ026-03-AP11-200	●	26	3	30	200	25			
MSZ026-03-AP11-250	●	26	3	40	250	25			
MSZ032-04-AP11-200	●	32	4	50	200	32			

● Stock item

○ Non Stock item

▲ Special order

Milling

INDEXABLE ENDMILLS

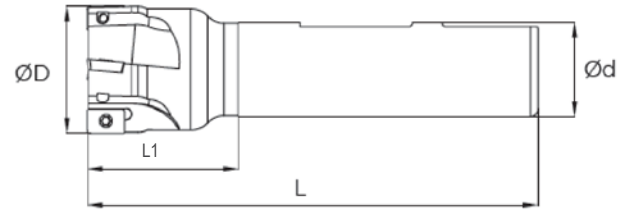
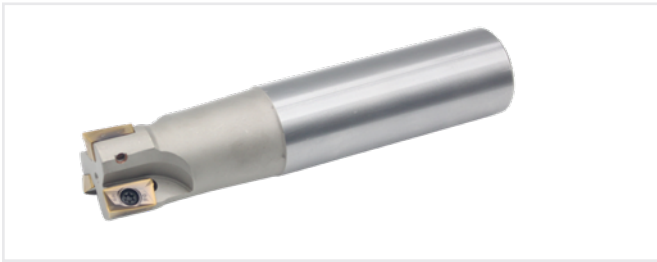

90°



Order Code	Stock Availability	D (mm)		L1 (mm)	L (mm)	d (mm)	Insert	Screw	Torx Key
MSZ025-02-AP16-170	●	25	2	50	170	25	APKT1604...	SM4X9	T15
MSZ026-02-AP16-200	●	26	2	30	200	25			
MSZ026-02-AP16-250	●	26	2	30	250	25			
MSZ032-03-AP16-170	●	32	3	50	170	32			
MSZ033-03-AP16-200	●	33	3	40	200	32			
MSZ033-03-AP16-250	●	33	3	40	250	32			
MSZ033-03-AP16-300	●	33	3	40	300	32			
MSZ033-03-AP16-350	●	33	3	40	350	32			
MSZ033-03-AP16-400	●	33	3	40	400	32			

Milling

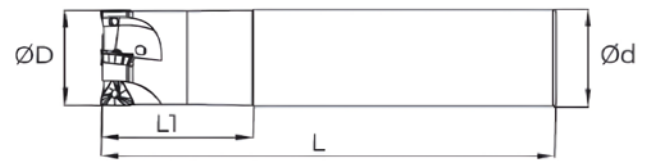

90°



Order Code	Stock Availability	D (mm)		L1 (mm)	L (mm)	d (mm)	Insert	Screw	Torx Key
MST020-02-3P10-150-C	●	20	2	40	150	20	3PKT1004..	SM2,5X7	T08
MST025-03-3P10-150-C	●	25	3	50	150	25			
MST032-04-3P10-150-C	●	32	4	35	150	32			

● Stock item

○ Non Stock item

△ Special order

INDEXABLE ENDMILLS

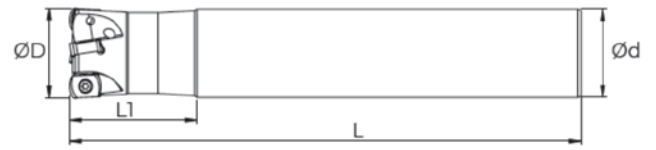

Order Code	Stock Availability	D (mm)		L1 (mm)	L (mm)	d (mm)	Insert	Screw	Torx Key
MST016-02-BL06-150-C	●	16	2	35	150	15	BLXP06T3ER	SM2,5X8	T08
MST016-02-BL06-150-C	●	16	2	35	150	16			
MST017-02-BL06-100-C	●	17	2	35	100	16			
MST017-02-BL06-150-C	●	17	2	35	150	16			
MST017-02-BL06-200-C	●	17	2	35	200	16			
MST020-03-BL06-150-C	●	20	3	35	150	20			
MST021-03-BL06-150-C	●	21	3	35	150	20			
MST021-03-BL06-200-C	●	21	3	35	200	20			
MST025-04-BL06-150-C	●	25	4	35	150	25			
MST026-04-BL06-150-C	●	26	4	35	150	25			
MST026-04-BL06-200-C	●	26	4	35	200	25			
MST032-05-BL06-200-C	●	32	5	35	200	32			
MST033-05-BL06-200-C	●	33	5	35	200	32			

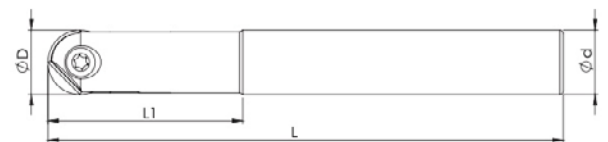

Order Code	Stock Availability	D (mm)	L1 (mm)	L (mm)	d (mm)	Uç	Screw	Torx Key
MSW08-01-RC08-130	○	8	36	130	10	RCE 08	SM3xd4,2xT08	T8
MSW010-01-RC10-130	●	10	30	130	12	RCE 10	SM5x0,5x9	T15
MSW012-01-RC12-150	●	12	32	130	12	RCE 12	SM5x0,5x10	T20
MSW016-01-RC16-140	●	16	36	140	16	RCE 16	SM5x0,5x12	
MSW020-01-RC20-200	●	20	45	160	20	RCE 20	SM4x0,5x17	
MSW025-01-RC25-200	●	25	45	160	25	RCE 25	SM6x0,75x20	
MSW030-01-RC30-200	○	30	66	200	32	RCE 30	SM8xd13x3Allen	A3
MSW032-01-RC32-200	○	32	66	200	32	RCE 32		

INDEXABLE ENDMILLS

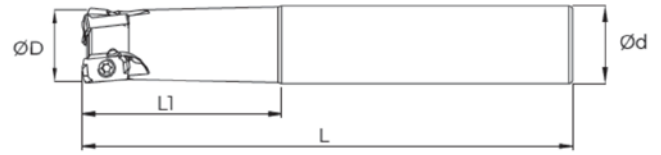
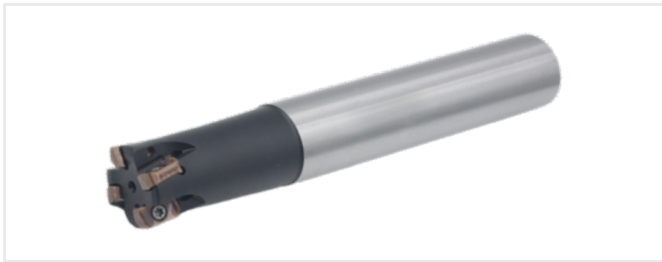

90°



Order Code	Stock Availability	D (mm)		L1 (mm)	L (mm)	d (mm)			
MSY016-02-LN03-160-C	●	16	2	30	160	16	LNGX0303...	SM3x8	T08-T10
MSY016-02-LN03-110-C	●	16	2	35	110	16			
MSY016-02-LN03-200-C	●	16	2	60	200	16			
MSY017-02-LN03-160-C	●	17	2	30	160	16			
MSY017-02-LN03-200-C	●	17	2	30	200	16			
MSY018-02-LN03-160-C	●	18	2	30	160	16			
MSY020-03-LN03-110-C	●	20	3	35	110	20			
MSY020-03-LN03-130-C	●	20	3	40	130	20			
MSY020-03-LN03-160-C	●	20	3	50	160	20			
MSY020-03-LN03-200-C	●	20	3	60	200	20			
MSY021-03-LN03-160-C	●	21	3	30	160	20			
MCY021-03-LN03-200-C	●	21	3	30	200	20			
MSY022-03-LN03-180-C	●	22	3	30	180	20			
MSY025-04-LN03-160-C	●	25	4	50	160	25			
MSY025-04-LN03-180-C	●	25	4	50	180	25			
MSY026-04-LN03-180-C	●	26	4	30	180	25			
MSY026-04-LN03-200-C	●	26	4	30	200	25			
MSY026-04-LN03-250-C	●	26	4	30	250	25			
MSY028-04-LN03-160-C	●	28	4	30	160	25			
MSY028-04-LN03-200-C	●	28	4	30	200	25			
MSY032-05-LN03-160-C	●	32	5	50	160	32			
MSY032-05-LN03-200-C	●	32	5	60	200	32			
MSY033-05-LN03-160-C	●	33	5	40	160	32			

Milling

● Stock item

○ Non Stock item

△ Special order

INDEXABLE ENDMILLS

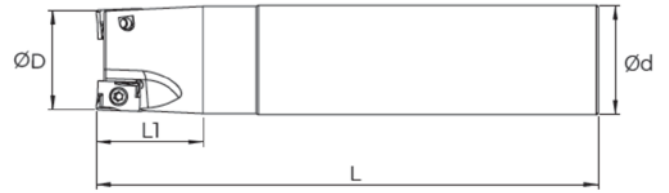

Order Code	Stock Availability	D (mm)		L1 (mm)	L (mm)	d (mm)	Insert	Screw	Torx Key
MSK016-01-LN10-090-C	●	16	1	35	90	16	LNMX1006...	M3X8	T10
MSK018-02-LN10-120-C	●	18	2	30	120	16			
MSK020-02-LN10-100-C	●	20	2	35	100	20			
MSK020-02-LN10-150-C	●	20	2	50	150	20			
MSK025-02-LN10-115-C	●	25	2	35	115	25			
MSK025-03-LN10-115-C	●	25	3	35	115	25			
MSK025-03-LN10-150-C	●	25	3	50	150	25			
MSK032-04-LN10-125-C	●	32	4	40	125	32			
MSK032-04-LN10-150-C	●	32	4	50	150	32			
MSK032-04-LN10-200-C	●	32	4	60	200	32			
MSK040-04-LN10-130-C	●	40	4	40	130	32			
MSK040-05-LN10-130-C	●	40	5	40	130	32			

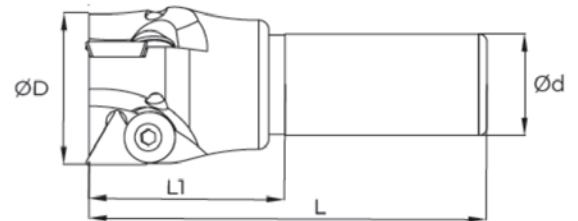

Order Code	Stock Availability	D (mm)		L1 (mm)	L (mm)	d (mm)	Insert	Screw	Torx Key
MSG035-02-TP16-100	●	35	2	50	100	25	TPKN16...	SM6X0,75	A4
MSG040-03-TP16-100	●	40	3	50	100	25			
MSG050-03-TP16-100	●	50	3	50	100	25			

● Stock item

○ Non Stock item

△ Special order

Milling

INDEXABLE ENDMILLS

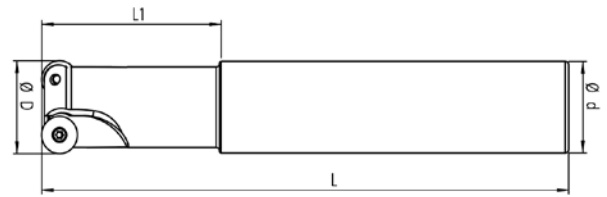

Order Code	Stock Availability	D(mm)		L1 (mm)	L (mm)	d (mm)	Insert	Screw	Torx Key
MSG016-02-RD0803-120-C	●	16	2	40	120	16	RD...0803	SM3X6	T10
MSG016-02-RD0803-150-C	●	16	2	40	150	16			
MSG017-02-RD0803-150-C	●	17	2	30	150	16			
MSG020-03-RD0803-150-C	●	20	3	50	150	20			
MSG020-02-RD1003-120-C	●	20	2	40	120	20	RD...1003		
MSG020-02-RD1003-150-C	●	20	2	50	150	20			
MSG020-02-RD1003-200-C	●	20	2	50	200	20			
MSG025-02-RD1003-150-C	●	25	2	50	150	25			
MSG025-02-RD1003-200-C	●	25	2	60	200	25			
MSG032-02-RD1003-250-C	●	32	2	100	250	32			
MSG032-03-RD1003-150-C	●	32	3	60	150	32			
MSG032-03-RD1003-200-C	●	32	3	60	200	32			
MSG032-03-RD1003-250-C	●	32	3	100	250	32			
MSG020-02-RD10T3-150-C	●	20	2	50	150	20			
MSG025-02-RD10T3-150-C	●	25	2	50	150	25			
MSG025-02-RD10T3-200-C	●	25	2	70	200	25			
MSG032-02-RD10T3-250-C	●	32	2	100	250	32			
MSG032-03-RD10T3-250-C	●	32	3	100	250	32			
MSG032-03-RD10T3-150-C	●	32	3	70	150	32			
MSG032-03-RD10T3-160-C	●	32	3	50	160	32			
MSG040-02-RD10T3-250-C	●	40	2	55	250	32			
MSG040-04-RD10T3-150-C	●	40	4	55	150	32			
MSG040-04-RD10T3-250-C	●	40	4	55	250	32			

Milling

● Stock item

○ Non Stock item

△ Special order

INDEXABLE ENDMILLS

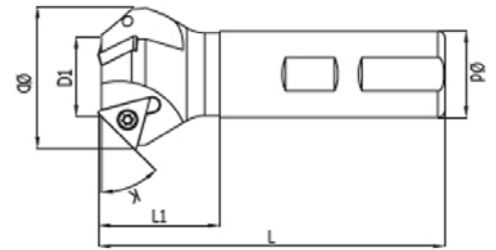

Order Code	Stock Availability	K	D (mm)	D1 (mm)	d (mm)	L (mm)	L1(mm)	Insert	Screw	Torx Key
MSG015-01-TC11-100	●	45°	15	1	4	16	L100	TCMT11..	M2,5X7	T08
MSG025-02-TC11-120	●	45°	25	2	14	16	L120			
MSG030-02-TC11-100	●	45°	30	2	16	16	L100			
MSG035-03-TC11-100	●	45°	35	3	21	16	L100			
MSG023-03-TC16-100	●	45°	23	3	5	16	L100	TCMT16..	M3,5X8	T15
MSG031-02-TC16-100	●	45°	31	2	10	16	L100			
MSG035-02-TC16-100	●	45°	35	2	14	20	L100			
MSG043-02-TC16-100	●	45°	43	2	22	25	L100			
MSG050-03-TC16-100	●	45°	50	3	30	25	L100			
MSG020-03-TC16-100	●	60°	20	3	6	16	L100			
MSG035-01-TC16-100	●	60°	35	1	20	20	L100			
MSG040-02-TC16-100	●	60°	40	2	24	25	L100			

Milling

● Stock item

○ Non Stock item

△ Special order

INDEXABLE ENDMILLS

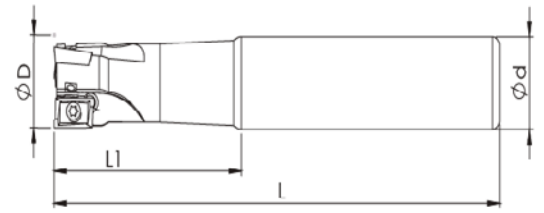

90°

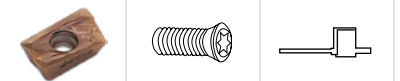

Order Code	Stock Availability	D (mm)		L1 (mm)	L (mm)	d (mm)	Insert	Screw	Torx Key
MSS016-02-R311-150	●	16	2	44	150	16	R39011T3...	M2,5X6	T08
MSS016-02-R311-150-C	●	16	2	44	150	16			
MSS016-02-R311-100	○	16	2	35	100	16			
MSS020-03-R311-150	●	20	3	50	150	20			
MSS020-03-R311-150-C	●	20	3	50	150	20			
MSS020-03-R311-100	○	20	3	40	100	20			
MSS025-03-R311-150	●	25	3	50	150	25			
MSS025-03-R311-150-C	●	25	3	50	150	25			
MSS025-03-R311-100	●	25	3	35	100	25			

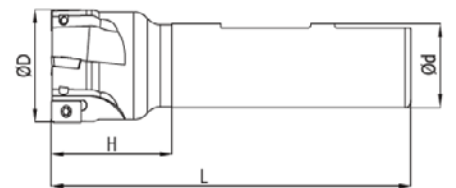

90°



Order Code	Stock Availability	D (mm)		L1 (mm)	L (mm)	d (mm)	Insert	Screw	Torx Key
MSE025-02-AP17-100-C	○	25	2	37	100	25	APKT1705...	SM4X8.4	T15
MSE032-03-AP17-110-C	○	32	3	39	110	32		M4X10	
MSE032-03-AP17-200-C	○	32	3	39	200	32			
MSE040-04-AP17-120-C	○	40	4	49	120	32			

● Stock item

○ Non Stock item

△ Special order

INDEXABLE ENDMILLS

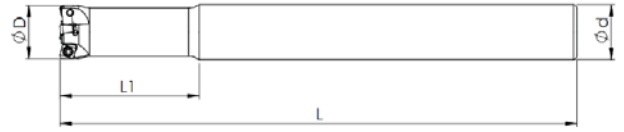

90°



Order Code	Stock Availability	D(mm)		L1(mm)	L(mm)	d(mm)	Insert	Screw	Torx Key
MST016-02-SN06-120	●	16	2	40	120	16	SNKT0603...	M3X8	T10
MST016-02-SN06-150-C	●	16	2	50	150	16			
MST017-02-SN06-150	●	17	2	30	150	16			
MST017-02-SN06-150-C	●	17	2	30	150	16			
MST017-02-SN06-200-C	●	17	2	30	200	16			
MST018-02-SN06-150-C	●	18	2	30	150	16			
MST020-03-SN06-120-C	●	20	3	40	120	20			
MST021-03-SN06-160-C	●	21	3	30	160	20			
MST021-03-SN06-200-C	●	21	3	30	200	20			
MST022-03-SN06-160-C	●	22	3	30	160	20			
MST025-03-SN06-150-C	●	25	3	40	150	25			
MST025-03-SN06-200-C	●	25	3	60	200	25			
MST026-03-SN06-200-C	●	26	3	30	200	25			

Milling



90°



Order Code	Stock Availability	D (mm)		L1 (mm)	L (mm)	d (mm)	Insert	Screw	Torx Key
MST025-02-6N06-150-C	○	25	2	50	150	25	6NGU0604...	M3X8	T10
MST032-03-6N06-150-C	○	32	3	50	150	32			

● Stock item

○ Non Stock item

△ Special order

INDEXABLE ENDMILLS

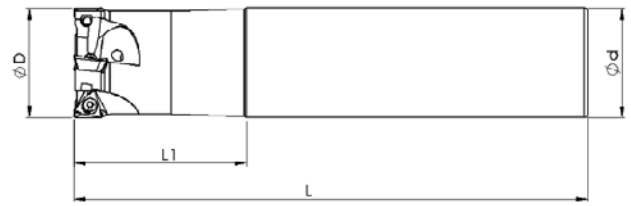

90°



Order Code	Stock Availability	D (mm)		L1 (mm)	L (mm)	d (mm)	Insert	Screw	Torx Key
MST032-03-3P15-150-C	●	32	3	30	150	25	3PKT1505...	M4,5X12	T20
MST032-03-3P15-200-C	●	32	3	60	200	32			

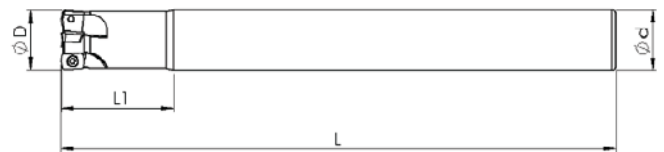

90°



Order Code	Stock Availability	D (mm)		L1 (mm)	L (mm)	d (mm)	Insert	Screw	Torx Key
MSY010-02-LP01-100	●	10	2	20	100	10	LPGU0102..	M2X5	T06
MSY011-02-LP01-120	●	11	2	22	120	10			
MSY012-02-LP01-120	●	12	2	20	120	11			
MSY012-03-LP01-120	●	12	3	20	120	11			
MSY012-02-LP01-100	●	12	2	25	100	12			
MSY012-02-LP01-120	●	12	2	25	120	12			
MSY012-03-LP01-120	●	12	3	25	120	12			
MSY012-03-LP01-150	●	12	3	80	150	12			
MSY014-03-LP01-120	●	14	3	30	120	14			
MSY016-04-LP01-160	●	16	4	30	160	16			

● Stock item

○ Non Stock item

△ Special order

INDEXABLE ENDMILLS

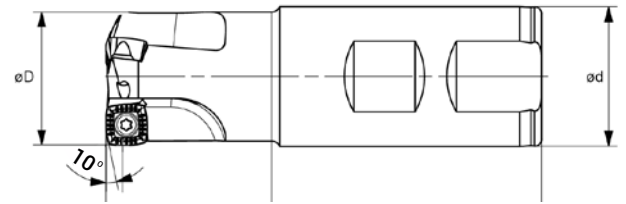
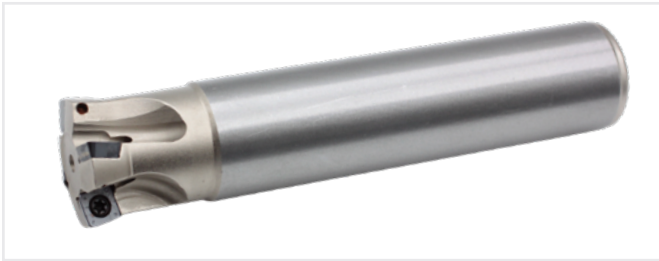

10°



Order Code	Stock Availability	D (mm)		L1 (mm)	L (mm)	d (mm)					
MSZ022-02-SD09-170-C	●	22	2	25	170	20	SDMT09T3...	M3,5X8	CK14	M3,5X10	T15
MSZ025-02-SD09-160-C	●	25	2	40	160	25					
MSZ025-03-SD09-160-C	●	25	3	50	160	25					
MSZ025-02-SD09-200-C	●	25	2	60	200	25					
MSZ025-03-SD09-200-C	●	25	3	60	200	25					
MSZ026-02-SD09-160-C	●	26	2	30	160	25					
MSZ026-03-SD09-160-C	●	26	3	30	160	25					
MSZ026-02-SD09-200-C	●	26	2	30	200	25					
MSZ032-03-SD09-150-C	●	32	3	50	150	32					
MSZ032-03-SD09-160-C	●	32	3	50	160	32					
MSZ032-03-SD09-200-C	●	32	3	60	200	32					
MSZ033-03-SD09-160-C	●	33	3	40	160	32					
MSZ033-03-SD09-200-C	●	33	3	30	200	32					
MSZ033-03-SD09-250-C	●	33	3	30	250	32					
MSZ035-04-SD09-160-C	●	35	4	30	160	32					
MSZ042-04-SD09-160-C	●	42	4	40	160	32					

Milling



90°



Order Code	Stock Availability	D (mm)		L1 (mm)	L (mm)	d (mm)			
MSE040-05-LN13-C	○	40	5	49	120	32	LNHU1306...	M4X11.5	T15

● Stock item

○ Non Stock item

△ Special order

INDEXABLE ENDMILLS

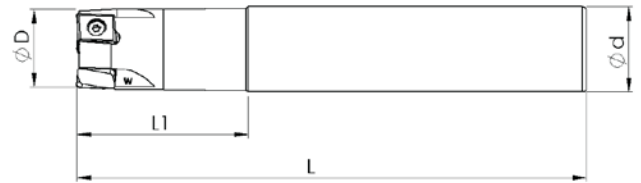

Order Code	Stock Availability	D (mm)		L1 (mm)	L (mm)	d (mm)	Insert	Screw	Torx Key
MSE020-02-LN09-110	○	20	2	30	110	20	LNHU0904...	M3X8.3	T09
MSE020-03-LN09-110	○	20	3	30	110	20			
MSE021-02-LN09-200	○	21	2	30	200	20			
MSE025-03-LN09-200-C	○	25	3	34	200	25			
MSE025-04-LN09-200-C	○	25	4	34	200	25			
MSE026-03-LN09-200-C	○	26	3	34	200	25			
MSE028-03-LN09-110-C	○	28	3	34	110	25			
MSE032-04-LN09-250-C	○	32	4	45	250	32			
MSE032-05-LN09-250-C	○	32	5	45	250	32			
MSE033-04-LN09-250-C	○	33	4	45	250	32			

Milling

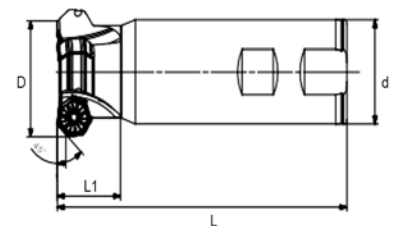

Order Code	Stock Availability	D (mm)		L1 (mm)	L (mm)	d (mm)	Insert	Screw	Torx Key	Shim	Shim Screw	Shim Screw Wrench
MSE040-03-XN07-C	○	40	3	28.3	130	40	XN0705...	SM3,5X12	T15	S-XN07030	SM5X8,5	A3,5

● Stock item

○ Non Stock item

△ Special order

INDEXABLE ENDMILLS

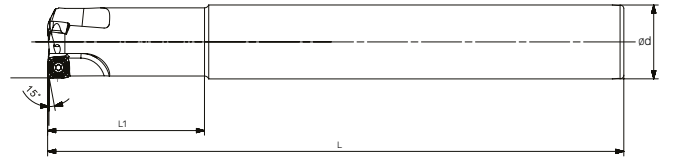

15°



Order Code	Stock Availability	D (mm)		L1 (mm)	L (mm)	d (mm)	Insert	Screw	Torx Key
MSE025-02-SD09-200-C	●	25	2	48	200	25	SDMT0904...	M3.5X8.6	T10
MSE026-02-SD09-180-C	●	26	2	28	180	25			
MSE032-03-SD09-250-C	●	32	3	67	250	32			

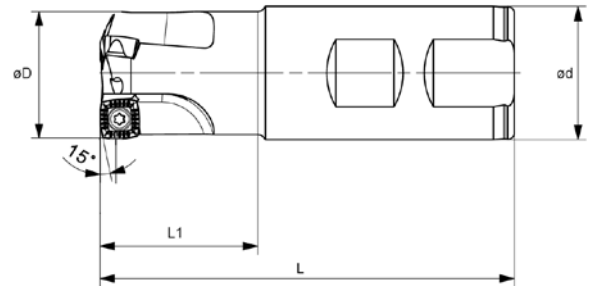

15°

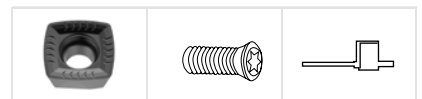

Order Code	Stock Availability	D (mm)		L1 (mm)	L (mm)	d (mm)	Insert	Screw	Torx Key
MSE025-02-SD09-96-C	●	25	2	37	96	25	SDMT0904...	M3.5X8.6	T10
MSE032-02-SD09-100-C	●	32	2	37	100	32			

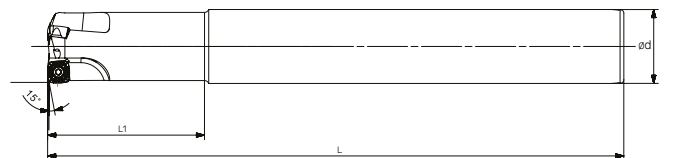

15°



Order Code	Stock Availability	D (mm)		L1 (mm)	L (mm)	d (mm)	Insert	Screw	Torx Key
MSE032-02-SD15-250-C	●	32	2	70	250	32	SDMT1205...	M4X11.2	T15

● Stock item

○ Non Stock item

△ Special order

Milling

INDEXABLE ENDMILLS

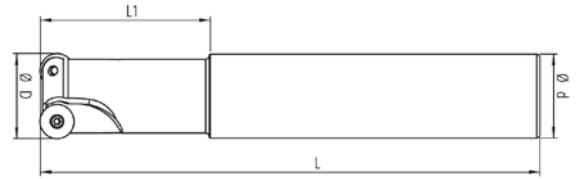

Order Code	Stock Availability	D (mm)		L1 (mm)	L (mm)	d (mm)	Insert	Screw	Torx Key
MSE015-03-RP10-225-C	●	15	3	56.2	225	25	RPHX10T3...	M3X7.2	T09
MSE022-04-RP10-130-C	●	22	4	65	130	32			

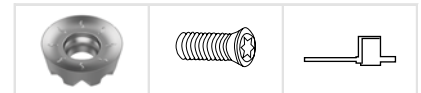
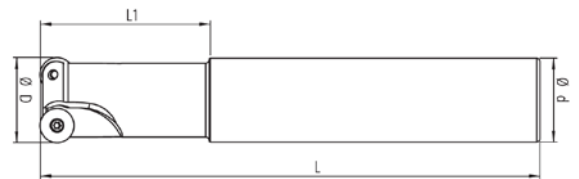

Order Code	Stock Availability	D (mm)		L1 (mm)	L (mm)	d (mm)	Insert	Screw	Torx Key
MSE032-03-RP12-120-C	○	32	3	33	120	32	RPHX1204...	M4X8.5	T10

Milling

● Stock item

○ Non Stock item

△ Special order

INDEXABLE ENDMILLS

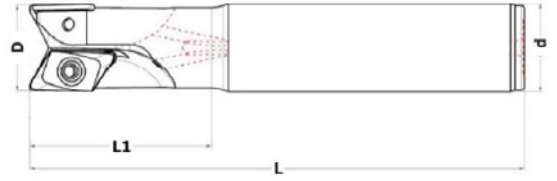
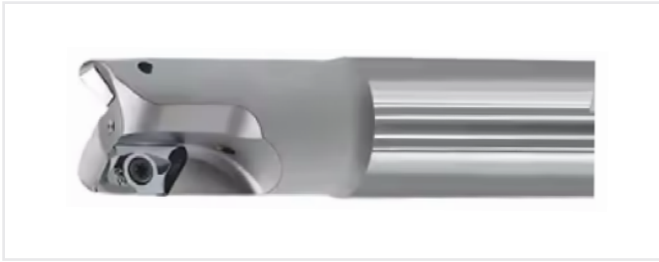

90°



Order Code	Stock Availability	D (mm)		L1 (mm)	L (mm)	d (mm)	Insert	Screw	Torx Key
MSK020-01-XE19-150-C	○	20	1	50	150	20	XEKT19...	SM4X10	T15
MSK025-02-XE19-150-C	○	25	2	50	150	25			
MSK032-02-XE19-150-C	○	32	2	50	150	32			
MSK040-03-XE19-150-C	○	40	3	60	150	32			

Milling

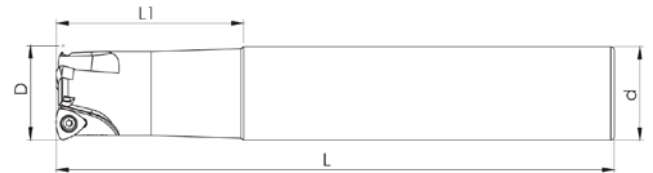

14°



Order Code	Stock Availability	D (mm)		L1 (mm)	L (mm)	d (mm)	Insert	Screw	Torx Key
MSK025-02-WN09-150-C	●	25	2	70	150	25	WNGX09T3..	SM3X8	T10
MSK032-03-WN09-150-C	●	32	3	70	150	32			

● Stock item

○ Non Stock item

△ Special order

INDEXABLE ENDMILLS

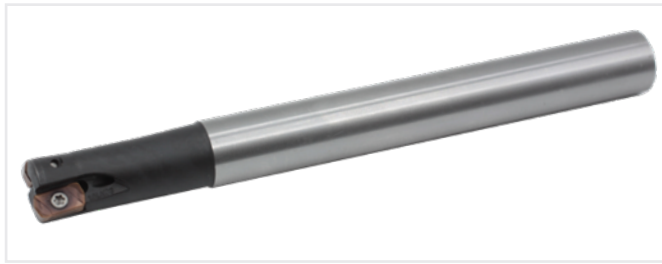

90°



Order Code	Stock Availability	D (mm)		L1 (mm)	L (mm)	d (mm)	Insert	Screw	Torx Key
MSU016-02-LN03-160-C	●	16	2	50	160	16	 LNET 0303	 M2.5X7	 T08
MSU016-02-LN03-200-C	●	16	2	60	200	16			
MSU016-02-LN03-200	●	16	2	60	250	16			
MSU017-02-LN03-160-C	●	17	2	30	160	16			
MSU017-02-LN03-200-C	●	17	2	30	200	16			
MSU018-02-LN03-150-C	●	18	2	30	150	16			
MSU020-03-LN03-160-C	●	20	3	50	160	20			
MSU020-03-LN03-200-C	●	20	3	60	200	20			
MSU021-03-LN03-160-C	●	21	3	30	160	20			
MSU021-03-LN03-200-C	●	21	3	30	200	20			
MSU022-03-LN03-160-C	●	22	3	30	160	20			
MSU025-04-LN03-160-C	●	25	4	50	160	25			
MSU025-04-LN03-200-C	●	25	4	60	200	25			
MSU026-04-LN03-160-C	●	26	4	30	160	25			
MSU026-04-LN03-200-C	●	26	4	30	200	25			
MSU026-04-LN03-250	●	26	4	30	250	25			
MSU032-04-LN03-160-C	●	32	4	50	160	32			
MSU032-04-LN03-200-C	●	32	4	60	200	32			
MSU033-05-LN03-160-C	●	33	5	30	160	32			
MSU033-04-LN03-200-C	●	33	4	30	200	32			

Milling

*For diameters $\varnothing 16$ mm and above, shank is available as an optional production. Please contact your sales representative for detailed information and availability.

● Stock item

○ Non Stock item

△ Special order

FACE MILLS

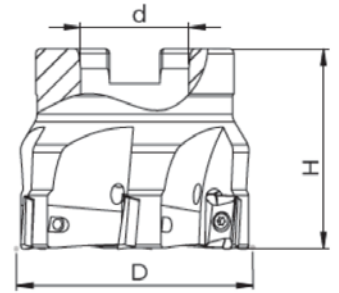

Insert	Screw	Torx Key
APKT1003...	SM2,5X7	T08

Order Code	Stock Availability	D (mm)		H (mm)	d (mm)
MCG040-05-AP10	●	40	5	45	16
MCG040-05-AP10-C	●	40	5	45	16
MCG050-06-AP10	●	50	6	45	22
MCG050-06-AP10-C	●	50	6	45	22
MCG063-06-AP10	●	63	6	45	22
MCG063-07-AP10	●	63	7	45	22
MCG063-07-AP10-C	●	63	7	45	22
MCG080-08-AP10	●	80	8	52	27
MCG080-08-AP10-C	●	80	8	52	27
MCG100-09-AP10	●	100	9	52	32
MCG100-09-AP10-C	●	100	9	52	32

Milling

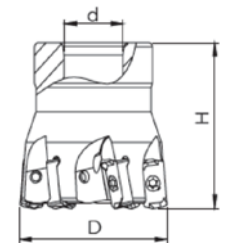

Insert	Screw	Torx Key
LNGX0303...	SM3X7	T08

Order Code	Stock Availability	D (mm)		H (mm)	d (mm)
MCY040-06-LN03-C	●	40	6	40	17
MCY050-06-LN03-C	●	50	6	50	22
MCY050-07-LN03-C	●	50	7	50	22
MCY052-06-LN03-C	●	52	6	50	22



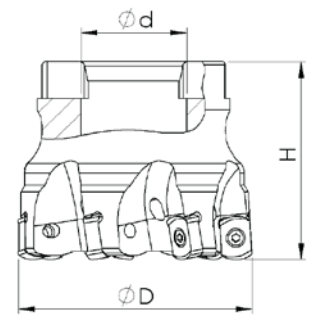

● Stock item ○ Non Stock item ▲ Special order

FACE MILLS



90°





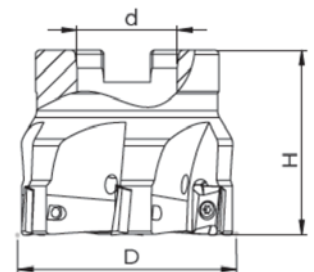

Order Code	Stock Availability	D (mm)		H (mm)	d (mm)			
MCT040-06-BL06-C	●	40	6	40	16	BLXP06T3..	SM2,5X8	T08
MCT050-07-BL06-C	●	50	7	50	22			
MCT063-08-BL06-C	●	63	8	50	22			



90°



Order Code	Stock Availability	D (mm)		H (mm)	d (mm)			
MCG040-05-AP11	●	40	5	45	16	APKT1103...	SM2,5X7	T08
MCG050-06-AP11	●	50	6	50	22			
MCG063-07-AP11	●	63	7	50	22			
MCG040-04-AP16	●	40	4	45	16	APKT16T3...	SM4X12	T15
MCG050-05-AP16	●	50	5	45	22			
MCG063-05-AP16	●	63	5	45	22			
MCG080-07-AP16	●	80	7	52	27			

● Stock item

○ Non Stock item

△ Special order

FACE MILLS

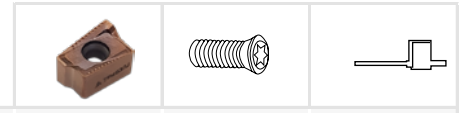
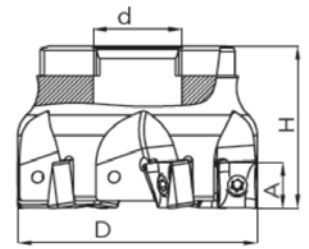

Order Code	Stock Availability	D (mm)		H (mm)	d (mm)	Insert	Screw	Torx Key
MCK040-04-LN10-C	●	40	4	40	16	LNMX1006...	SM3X10	T10
MCK040-05-LN10-C	●	40	5	40	16			
MCK050-06-LN10-C	●	50	6	40	22			
MCK050-04-LN15-C	●	50	4	40	22	LNMX1510...	SM4X14	T15
MCK063-06-LN15-C	●	63	6	40	22			
MCK080-07-LN15-C	●	80	7	52	27			
MCK100-08-LN15-C	●	100	8	52	32			
MCK125-10-LN15	●	125	10	62	40			
MCK160-12-LN15	●	160	12	62	40			

Milling

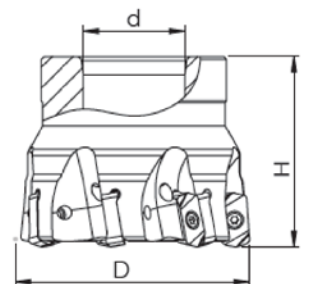

Order Code	Stock Availability	D (mm)		H (mm)	d (mm)	Insert	Screw	Torx Key
MCU040-06-LN03-C	●	40	6	40	16	LNET0303..	SM2,5X7	T08
MCU050-07-LN03-C	●	50	7	40	22			
MCU052-07-LN03-C	●	52	7	40	22			
MCU063-08-LN03-C	●	63	8	40	22			

● Stock item

○ Non Stock item

△ Special order

FACE MILLS

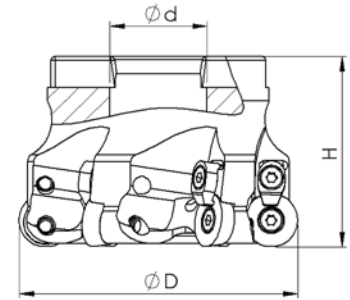

90°



Order Code	Stock Availability	D(mm)		H(mm)	d (mm)	Insert	Screw	Plat Clamp	Screw	Torx Key					
MCG040-04-RD1003-C	●	40	4	40	16	RD..1003	SM3,5X10	CCK14M	SM3,5X8	T15					
MCG050-05-RD1003-C	●	50	5	46	22										
MCG063-06-RD1003-C	●	63	6	50	22										
MCG080-07-RD1003-C	●	80	7	52	27										
MCG100-08-RD1003-C	●	100	8	52	32										
MCG050-05-RD10T3-C	●	50	5	40	22						RD..10T3	SM3,5X10	CCK14M	SM3,5X8	T15
MCG063-06-RD10T3-C	●	63	6	40	22										
MCG080-07-RD10T3-C	●	80	7	50	27										
MCG100-08-RD10T3-C	●	100	8	52	32										
MCG040-04-RD12T3-C	●	40	4	40	16	RD..12T3	SM3,5X10	CCK14M	SM3,5X8	T15					
MCG050-05-RD12T3-C	●	50	5	46	22										
MCG052-05-RD12T3-C	●	52	5	46	22										
MCG063-06-RD12T3-C	●	63	6	50	22										
MCG080-07-RD12T3-C	●	80	7	52	27										
MCG100-08-RD12T3-C	●	100	8	52	32										
MCG125-09-RD12T3	●	125	9	62	40										
MCG160-10-RD12T3	●	160	10	62	40										
MCG160-10-RD12T3-C	●	160	10	62	40	RD..1604	SMSX12	CTP11M	SM4X11	T20					
MCG050-04-RD1604-C	●	50	4	50	22										
MCG052-04-RD1604-C	●	52	4	50	22										
MCG063-04-RD1604-C	●	63	4	50	22										
MCG066-05-RD1604-C	●	66	5	50	27										
MCG080-05-RD1604-C	●	80	5	52	27										
MCG100-06-RD1604-C	●	100	6	52	32										
MCG125-07-RD1604	●	125	7	62	40										
MCG160-08-RD1604	●	160	8	62	40										

Milling

● Stock item



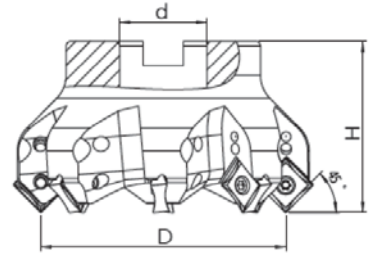

○ Non Stock item

△ Special order

FACE MILLS





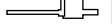

45° 

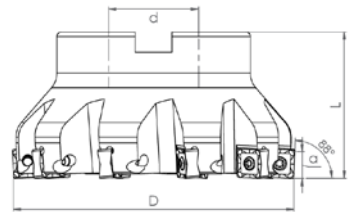
Order Code	Stock Availability	D (mm)		H (mm)	d (mm)					
MCK050-05-SN12-45	●	50	5	40	22	SNMX1205 SNMX1206	SM4X11	CCK15M	M4X11	T15
MCK063-06-SN12-45	●	63	6	40	22					
MCK080-08-SN12-45	●	80	8	50	27					
MCK100-10-SN12-45	●	100	10	50	32					
MCK125-11-SN12-45	●	125	11	62	40					
MCK160-12-SN12-45	●	160	12	62	40					

Milling



88° 

Order Code	Stock Availability	D (mm)		H (mm)	d (mm)			
MCK050-05-SN12-88-C	●	50	5	40	22	SNMX1206...	SM4,5X11	T20
MCK063-06-SN12-88-C	●	63	6	40	22			
MCK080-08-SN12-88-C	●	80	8	50	27			
MCK100-10-SN12-88-C	●	100	10	50	32			
MCK125-11-SN12-88	●	125	11	62	40			
MCK160-12-SN12-88	●	160	12	62	50			
MCK200-14-SN12-88	●	200	14	62	60			

* Use SM4x12x6 screws for SNMX1205 inserts.

● Stock item

○ Non Stock item

△ Special order

FACE MILLS

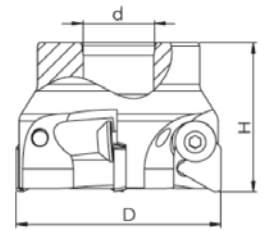

90°

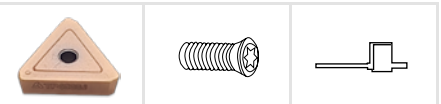

Order Code	Stock Availability	D (mm)		H (mm)	d (mm)	Insert	Screw	Torx Key
MCG050-03-TP16	●	50	3	41	22	TPKN16...	SM6X0,75	A4
MCG063-04-TP16	●	63	4	48	22			
MCG080-05-TP16	●	80	5	52	32			
MCG100-06-TP16	●	100	6	52	32			
MCG063-03-TP22	●	63	3	48	22	TPKN22...	SM8X1	A5
MCG080-04-TP22	●	80	4	52	32			
MCG100-05-TP22	●	100	5	52	32			
MCG125-06-TP22	●	125	6	62	40			
MCG160-07-TP22	●	160	7	62	40			
MCG200-08-TP22	●	200	8	62	60			
MCG250-10-TP22	●	250	10	62	60			

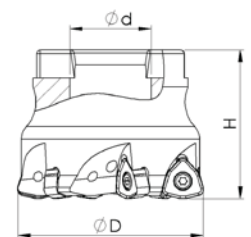

14°

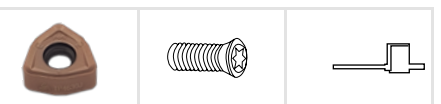

Order Code	Stock Availability	D (mm)		H (mm)	d (mm)	Insert	Screw	Torx Key
MCK040-04-WN09-C	●	40	4	40	16	WNGX09T3...	SM3X10	T10
MCK050-04-WN09-C	●	50	4	40	22			
MCK052-04-WN09-C	●	52	4	40	22			
MCK052-05-WN09-C	●	52	5	40	22			
MCK052-06-WN09-C	●	52	6	40	22			
MCK063-05-WN09-C	●	63	5	40	22			
MCK066-06-WN09-C	●	66	6	50	22			
MCK066-06-WN09-C	●	66	6	50	27			

FACE MILLS

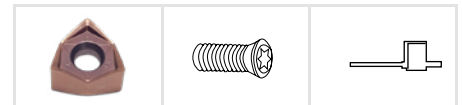
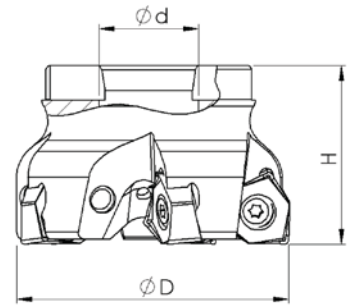

Order Code	Stock Availability	D (mm)		H (mm)	d (mm)	Insert	Screw	Torx Key
MCY050-04-WN08-C	●	50	4	40	22	WNMU0806...	SM5X12	T20
MCY052-04-WN08-C	●	52	4	40	22			
MCY063-05-WN08-C	●	63	5	40	22			
MCY080-06-WN08-C	●	80	6	45	27			
MCY100-07-WN08-C	●	100	7	50	32			
MCY125-08-WN08	●	125	8	50	40			
MCY160-10-WN08	●	160	10	62	40			
MCY200-12-WN08	●	200	12	62	50			

Milling

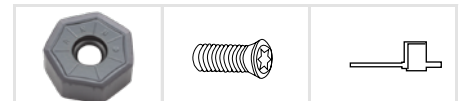
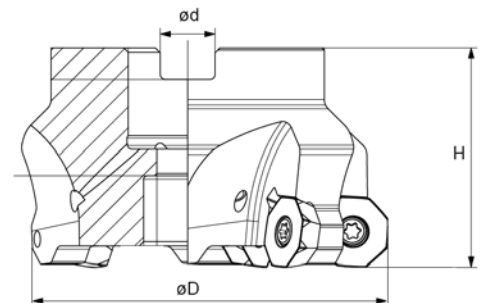

Order Code	Stock Availability	D (mm)		H (mm)	d (mm)	Insert	Screw	Torx Key
MCA050-04-XN07	●	50	4	40	22	XNMU0705...	SM4X10	T15
MCA063-05-XN07	●	63	5	40	22			
MCA080-06-XN07	●	80	6	50	27			
MCA100-07-XN07	●	100	7	50	32			
MCA125-08-XN07	●	125	8	55	40			
MCA160-10-XN07	●	160	10	55	40			

● Stock item

○ Non Stock item

△ Special order

FACE MILLS

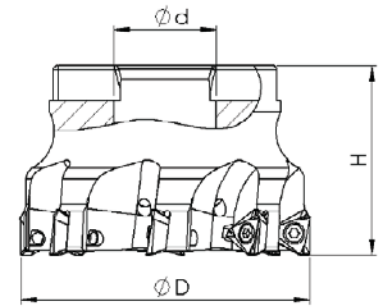

90°

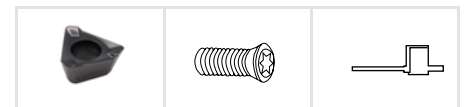

Order Code	Stock Availability	D (mm)		H (mm)	d (mm)	Insert	Screw	Torx Key
MCT050-04-3P15-C	●	50	4	40	22	3PKT1505...	M4,5X12	T20
MCT063-05-3P15-C	●	63	5	40	22			
MCT080-07-3P15-C	●	80	7	50	27			
MCT100-08-3P15-C	●	100	8	50	32			
MCT040-04-3P10 -C	●	40	4	40	16	3PKT1004...	M3X8	T10
MCT050-05-3P10-C	●	50	5	40	22			
MCT063-08-3P10-C	●	63	8	40	22			

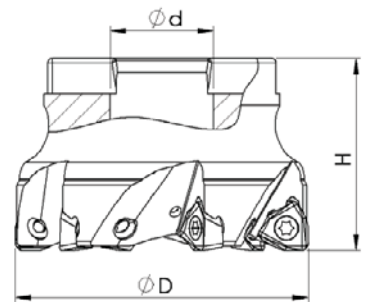

90°



Order Code	Stock Availability	D (mm)		H (mm)	d (mm)	Insert	Screw	Torx Key
MCT040-04-6N06-C	●	40	4	40	16	6NGU0604...	M3X8	T10
MCT050-05-6N06-C	●	50	5	40	22			
MCT063-06-6N06-C	●	63	6	40	22			
MCT050-05-6N09-C	●	50	5	40	22	6NGU0905...	M4X11	T15
MCT063-06-6N09-C	●	63	6	40	22			
MCT080-07-6N09-C	●	80	7	50	27			
MCT100-08-6N09-C	●	100	8	50	32			
MCT125-10-6N09	●	125	10	62	40			

● Stock item

○ Non Stock item

△ Special order

FACE MILLS

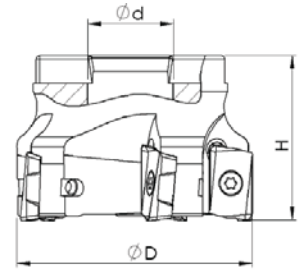

90°



Order Code	Stock Availability	D (mm)		H (mm)	d (mm)	Insert	Screw	Torx Key
MCS040-05-R311-C	●	40	5	40	16	R39011T3...	M2,5X7	T08
MCS050-06-R311-C	●	50	6	40	22			
MCS063-07-R311-C	●	63	7	50	22			

Milling

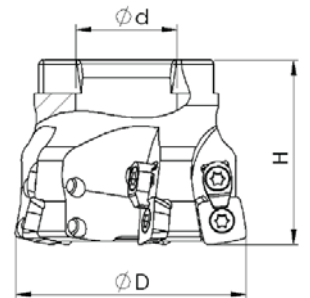

10°



Order Code	Stock Availability	D (mm)		H (mm)	d (mm)	Insert	Screw	Clamp	Screw	Torx Key
MCZ040-04-SD09-C	●	40	4	40	16	SDMT09T3...	M3,5X11	CCK14M	M3,5X11	T15
MCZ050-04-SD09-C	●	50	4	40	22					
MCZ050-05-SD09-C	●	50	5	40	22					
MCZ052-05-SD09-C	●	52	5	40	22					
MCZ052-06-SD09-C	●	52	6	40	22					
MCZ060-06-SD09-C	●	60	6	40	22					
MCZ063-06-SD09-C	●	63	6	40	22					
MCZ080-07-SD09-C	●	80	7	50	27					
MCZ100-08-SD09-C	●	100	8	50	32					

● Stock item

○ Non Stock item



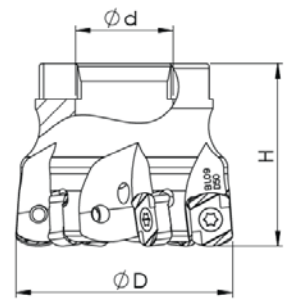

△ Special order

FACE MILLS



90°





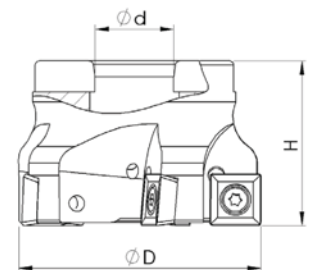

Order Code	Stock Availability	D (mm)		H (mm)	d (mm)			
MCT040-05-BL09-C	●	40	5	40	16	BLXP09T3..	M3,5X10	T15
MCT050-06-BL09-C	●	50	6	40	22			
MCT052-06-BL09-C	●	52	6	40	22			
MCT063-07-BL09-C	●	63	7	40	22			



90°



Order Code	Stock Availability	D (mm)		H (mm)	d (mm)			
MCW050-04-SP12-C	●	50	4	45	22	SPMT1204...	M4,5X12	T20
MCW063-05-SP12-C	●	63	5	50	22			

Milling

● Stock item

○ Non Stock item

△ Special order

FACE MILLS

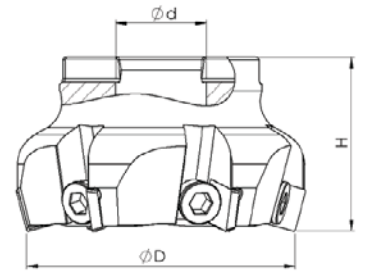

75°

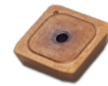

Order Code	Stock Availability	D (mm)		H (mm)	d (mm)	Insert	Screw	Torx Key
MCG063-05-SP12	●	63	5	40	22	SPKN1203...	M8X1 L	A6
MCG080-06-SP12	●	80	6	50	27			
MCG100-08-SP12	●	100	8	50	32			
MCG125-10-SP12	●	125	10	62	40			
MCG160-12-SP12	●	160	12	62	40			
MCG200-12-SP12	●	200	12	62	60			

Milling

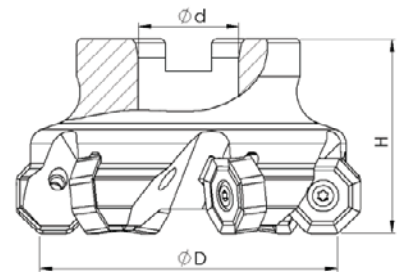

45°



Order Code	Stock Availability	D (mm)		H (mm)	d (mm)	Insert	Screw	Torx Key
MCZ050-04-ON08-C	●	50	4	50	22	ONHU08T6...	M4,5X15	T20
MCZ080-06-ON08-C	●	80	6	50	27			
MCZ100-07-ON08-C	●	100	7	50	32			
MCZ125-08-ON08	●	125	8	62	40			
MCZ160-10-ON08	●	160	10	62	40			

● Stock item

○ Non Stock item

△ Special order

FACE MILLS

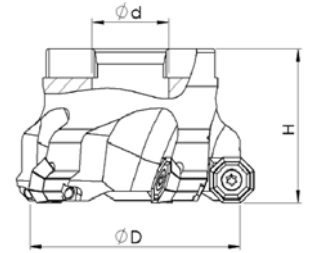
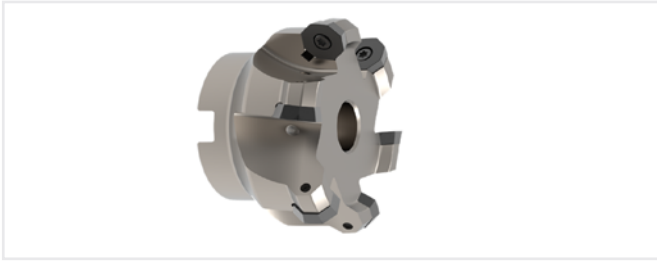

40°

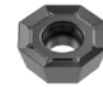

Order Code	Stock Availability	D (mm)		H (mm)	d (mm)	Insert	Screw	Torx Key
MCE050-04-OD06-C	○	50	4	40	16	ODMT0605...	M4.5X12 A43	T20
MCE063-05-OD06-C	○	63	5	40	22			
MCE80-05-OD06-C	○	80	5	50	27			
MCE080-06-OD06-C	○	80	6	50	27			
MCE100-06-OD06-C	○	100	6	50	32			
MCE100-07-OD06-C	○	100	7	50	32			
MCE125-07-OD06-C	○	125	7	63	40			
MCE125-08-OD06-C	○	125	8	63	40			
MCE160-10-OD06	○	160	10	63	40			

Milling

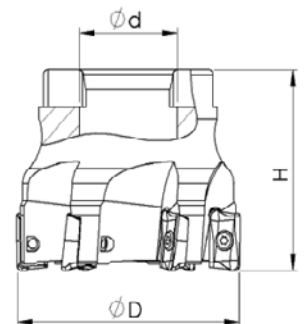

90°



Order Code	Stock Availability	D (mm)		H (mm)	d (mm)	Insert	Screw	Torx Key
MCE050-05-AP17-C	○	50	5	40	22	APKT1705...	SM4X10	T15
MCE063-06-AP17-C	●	63	6	40	22			
MCE080-06-AP17-C	●	80	6	50	27			
MCE100-08-AP17-C	○	100	8	50	32			

● Stock item

○ Non Stock item





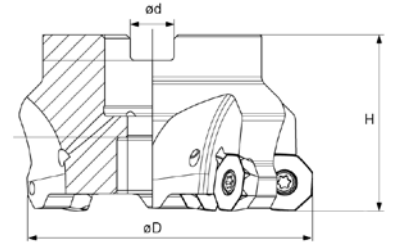
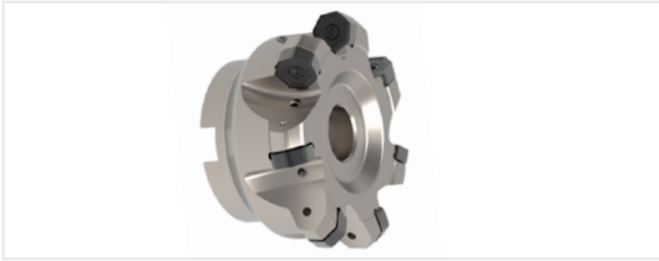

△ Special order

FACE MILLS



45°





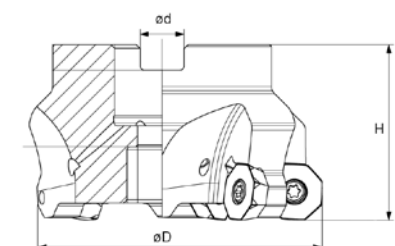
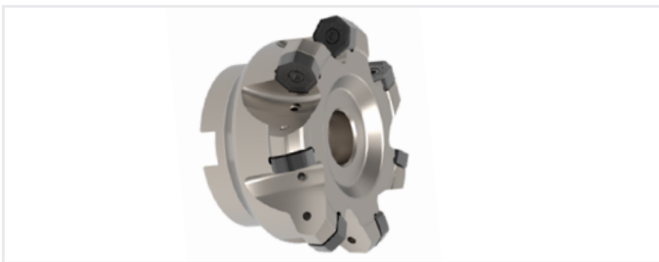



Order Code	Stock Availability	D (mm)		H (mm)	d (mm)						
MCE040-03-XN07-C	○	40	3	40	6	XNMMU0705...	M3.5X12	T15	S-XN07030	SS0585F	A3.5
MCE050-04-XN07-C	○	50	4	40	22						
MCE050-05-XN07-C	○	50	5	40	22						
MCE063-05-XN07-C	●	63	5	40	22						
MCE063-06-XN07-C	●	63	6	40	22						
MCE080-06-XN07-C	●	80	6	50	27						
MCE080-07-XN07-C	●	80	7	50	27						
MCE100-07-XN07-C	●	100	7	50	32						
MCE100-08-XN07-C	●	100	8	50	32						
MCE125-08-XN07-C	●	125	8	63	40						
MCE125-10-XN07-C	○	125	10	63	40						
MCE160-09-XN07	○	160	9	63	40						
MCE160-12-XN07	○	160	12	63	40						
MCE200-14-XN07	○	200	14	63	60						



45°



Order Code	Stock Availability	D (mm)		H (mm)	d (mm)						
MCE063-05-XN09-C	○	63	5	40	22	XNMMU0906...	M5X13	T20	S-XN09040	SS0810F	A5
MCE080-06-XN09-C	○	80	6	50	27						
MCE100-07-XN09-C	○	100	7	50	32						
MCE100-08-XN09-C	○	100	8	50	32						
MCE125-08-XN09-C	○	125	8	63	40						
MCE125-10-XN09-C	○	125	10	63	40						
MCE160-09-XN09	○	160	9	63	40						
MCE160-11-XN09	○	160	11	63	40						
MCE200-12-XN09	○	200	12	63	60						
MCE250-12-XN09	△	250	12	63	60						
MCE315-14-XN09	△	315	14	63	60						

FACE MILLS

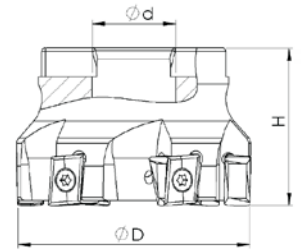
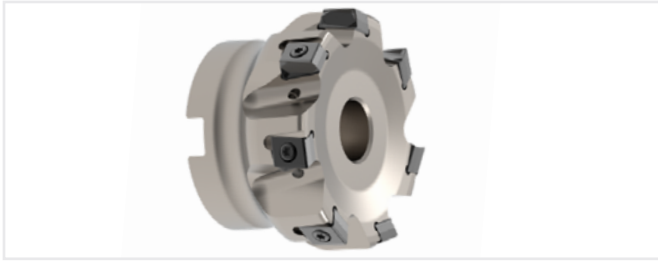

90°



Order Code	Stock Availability	D (mm)		H (mm)	d (mm)	Insert	Screw	Torx Key
MCE040-04-LN09-C	○	40	4	40	16	LNHU0904...	SM3X8.3	T09
MCE040-06-LN09-C	○	40	6	40	16			
MCE050-05-LN09-C	○	50	5	40	22			
MCE050-07-LN09-C	○	50	7	40	22			
MCE063-07-LN09-C	○	63	7	40	22			
MCE063-10-LN09-C	○	63	10	40	22			
MCE080-09-LN09-C	○	80	9	50	27			
MCE080-13-LN09-C	○	80	13	50	27			

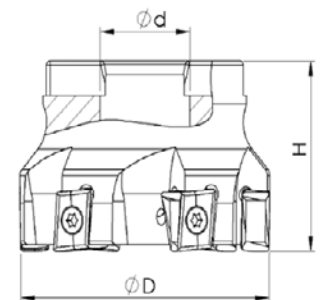
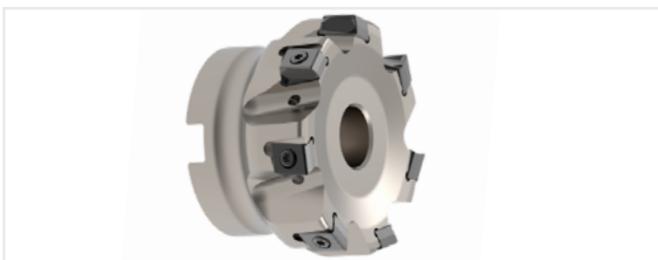

90°



Order Code	Stock Availability	D (mm)		H (mm)	d (mm)	Insert	Screw	Torx Key
MCE063-04-LN16-C	○	63	4	40	22	LNHU1607...	M5X13 A63	T20
MCE080-05-LN16-C	○	80	5	50	27			
MCE100-06-LN16-C	○	100	6	50	32			
MCE125-07-LN16-C	○	125	7	63	40			
MCE160-08-LN16-C	○	160	8	63	40			

● Stock item

○ Non Stock item



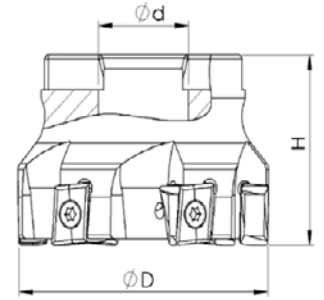
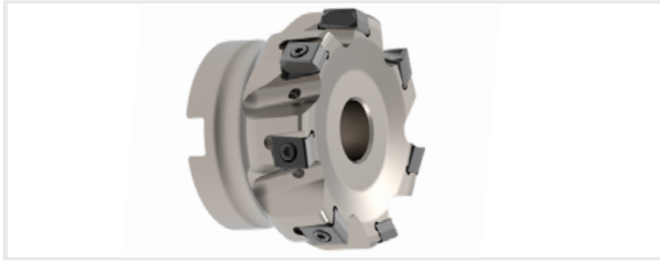

△ Special order

FACE MILLS



90°



Order Code	Stock Availability	D (mm)		H (mm)	d (mm)			
MCE040-04-LN13-C	○	40	4	40	16	LNHU1306...	SM4X11.2	T15
MCE040-05-LN13-C	○	40	5	40	16			
MCE050-05-LN13-C	○	50	5	40	22			
MCE050-06-LN13-C	○	50	6	40	22			
MCE063-04-LN13-C	○	63	4	40	22			
MCE063-06-LN13-C	○	63	6	40	22			
MCE063-08-LN13-C	○	63	8	40	22			
MCE080-05-LN13-C	○	80	5	50	27			
MCE080-07-LN13-C	○	80	7	50	27			
MCE080-10-LN13-C	○	80	10	50	27			
MCE100-07-LN13-C	○	100	7	50	32			
MCE100-09-LN13-C	○	100	9	50	32			
MCE100-13-LN13-C	○	100	13	50	32			
MCE125-09-LN13-C	○	125	9	63	40			
MCE125-11-LN13-C	○	125	11	63	40			
MCE125-16-LN13-C	○	125	16	63	40			
MCE160-09-LN13	○	160	9	63	40			
MCE160-13-LN13	○	160	13	63	40			
MCE200-12-LN13	○	200	12	63	60			
MCE250-12-LN13	○	250	12	63	60			

Milling

● Stock item

○ Non Stock item

▲ Special order

FACE MILLS

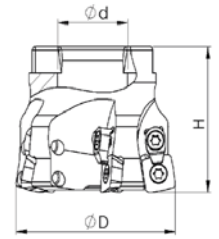
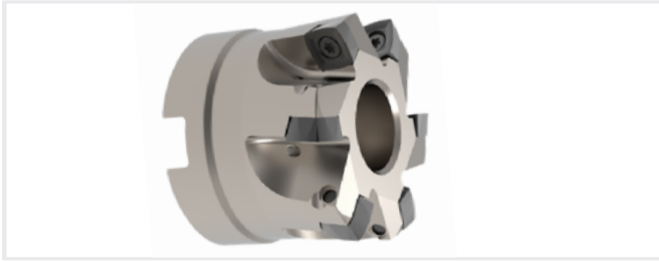

15°



Order Code	Stock Availability	D (mm)		H (mm)	d (mm)	Insert	Screw	Torx Key
MCE040-03-SD09-C	○	40	3	32	16	SDMT0904...	M3.5X8.6	T10
MCE040-04-SD09-C	●	40	4	32	16			
MCE040-05-SD09-C	○	40	5	32	16			
MCE050-05-SD09-C	●	50	5	40	22			
MCE050-06-SD09-C	○	50	6	40	22			

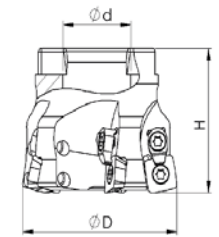

15°

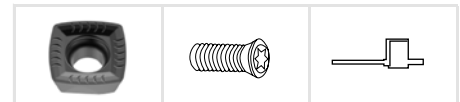

Order Code	Stock Availability	D (mm)		H (mm)	d (mm)	Insert	Screw	Torx Key
MCE052-03-SD12-C	○	52	3	40	22	SDMT1205...	M4X11.2	DT-TP10
MCE052-04-SD12-C	●	52	4	40	22			
MCE052-05-SD12-C	○	52	5	40	22			
MCE063-04-SD12-C	●	63	4	40	22			
MCE063-05-SD12-C	○	63	5	40	22			
MCE066-04-SD12-C	○	66	4	45	27			
MCE066-05-SD12-C	○	66	5	45	27			
MCE080-05-SD12-C	●	80	5	50	27			
MCE080-08-SD12-C	●	80	8	50	27			
MCE100-06-SD12-C	●	100	6	50	32			
MCE100-09-SD12-C	○	100	9	50	32			
MCE125-08-SD12-C	○	125	8	63	40			
MCE125-11-SD12-C	○	125	11	63	40			

FACE MILLS

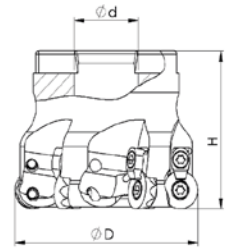
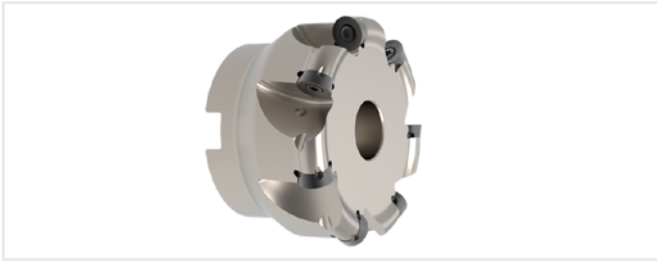

Insert	Screw	Torx Key						
MCE030-05-RP10-C	●	30	5	40	16	RPHX10T3...	M3X7.2	T09
MCE040-06-RP10-C	●	40	6	40	22		M3X7.2	T09

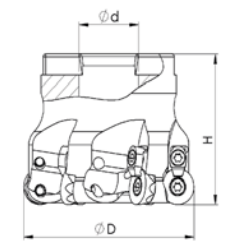

Insert	Screw	Torx Key						
MCE040-04-RP12-C	○	40	4	40	16	RPHX1204...	M4X8.5	T10
MCE050-05-RP12-C	●	50	5	40	22			
MCE063-06-RP12-C	●	63	6	40	22			
MCE080-07-RP12-C	○	80	7	50	27			

Milling

● Stock item

○ Non Stock item

▲ Special order

FACE MILLS

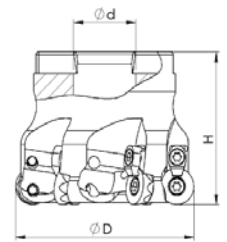
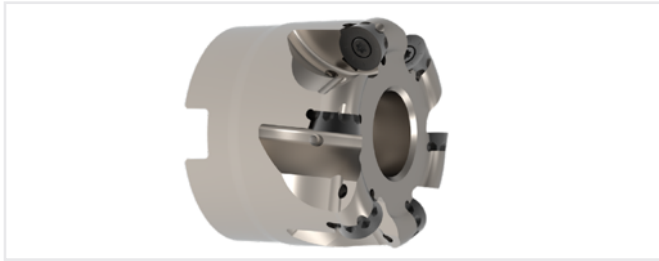

Insert	Screw	Torx Key						
MCE063-05-RP16-C	●	63	5	40	22	RPHX1605...	M5X12	T20
MCE080-06-RP16-C	●	80	6	50	27			
MCE100-07-RP16-C	●	100	7	50	32			

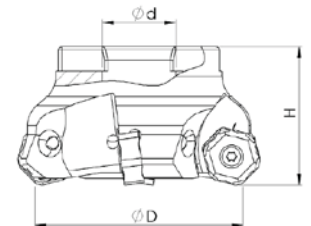

45°



Insert	Screw	Torx Key						
MCE063-04-HN09-C	○	63	4	40	22	HNGX0906...	M4.5X12	T15
MCE063-05-HN09-C	○	63	5	40	22			
MCE080-05-HN09-C	○	80	5	50	27			
MCE080-06-HN09-C	○	80	6	50	27			
MCE100-06-HN09-C	○	100	6	50	32			
MCE100-08-HN09-C	○	100	8	50	32			
MCE100-10-HN09-C	○	100	10	50	32			
MCE125-06-HN09-C	○	125	6	63	40			
MCE125-10-HN09-C	○	125	10	63	40			
MCE125-12-HN09-C	○	125	12	63	40			
MCE160-08-HN09	△	160	8	63	40			
MCE160-12-HN09	△	160	12	63	40			

● Stock item

○ Non Stock item

△ Special order

FACE MILLS

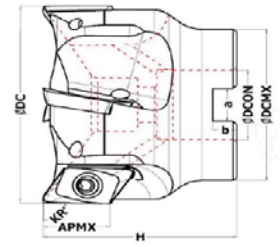

Insert	Screw	Torx Key
XEKT19...	SM4X10	T15

Order Code	Stock Availability	D (mm)		H (mm)	d (mm)	a	b	APMX
MCK040-03-XE19-C	○	40	3	45	34	8.8	6	17
MCK050-04-XE19-C	○	50	4	50	42	9.6	6.3	17
MCK063-04-XE19-C	○	63	4	50	48	10.3	6.3	17
MCK080-05-XE19-C	○	80	5	50	57	12.3	7.3	17
MCK100-06-XE19-C	○	100	6	52	70	12.3	8.3	17
MCK125-07-XE19-C	○	125	7	54	87	16.3	9.3	17

Milling

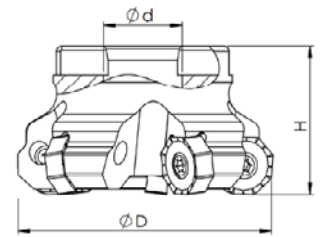

Insert	Screw	Torx Key
ONHU0604...	M5X12	T20

Order Code	Stock Availability	D (mm)		H (mm)	d (mm)
MCZ063-05-ON06	●	63	5	40	22
MCZ080-07-ON06	●	80	7	50	27
MCZ100-08-ON06	●	100	8	52	32
MCZ125-09-ON06	●	125	9	62	40

● Stock item

○ Non Stock item

△ Special order

HELICAL MILLING CUTTERS

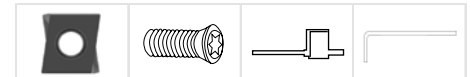
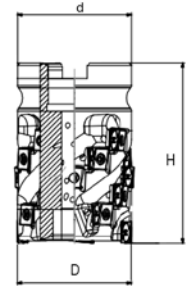
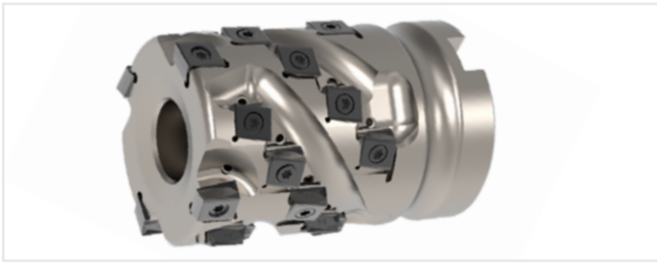

Order Code	Stock Availability	D (mm)		H (mm)	d (mm)	Row	Total Insert	Insert	Screw	Torx Key	Installation Wrench
MCE040-03/12-LN09-C	○	40	3	55	16	4	12	LNHU0904..	M3X8.3	T09	A15/24
MCE040-03/15-LN09-C	○	40	3	65	16	5	15				
MCE050-03/24-LN09-C	○	50	4	75	22	6	24				

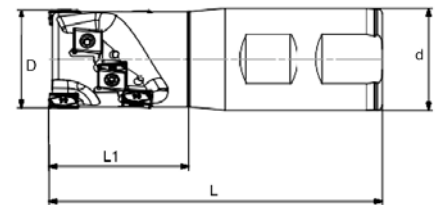

Order Code	Stock Availability	D (mm)		L1 (mm)	L (mm)	d (mm)	Insert	Row	Total Insert	APMX	Screw	Torx Key	Installation Wrench
MSE025-02/08-LN09-100-C	○	25	2	43	100	25	LNHU0904..	4	8	31	M3X8.3	T09	A15/24
MSE032-02/08-LN09-105-C	○	32	2	44	105	32		5	10	39			
MSE032-02/10-LN09-110-C	○	32	2	50	110	32		5	15	39			
MSE040-03/15-LN09-125-C	○	40	3	55	125	40		6	18	46			
MSE040-03/18-LN09-130-C	○	40	3	59	130	40		6	18	46			

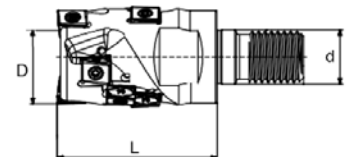

Order Code	Stock Availability	D (mm)		L1 (mm)	L (mm)	d (mm)	M	Row	Total Insert	APMX	Insert	Screw	Torx Key	Installation Wrench
MTE025-02/06-LN09-C	○	25	2	40	64	12.5	M12	3	6	23	LNHU0904..	M3X8.3	T09	A15/24
MTE032-02/06-LN09-C	○	32	2	40	67	17	M16	3	6	23				
MTE032-02/08-LN09-C	○	32	2	50	77	17	M16	4	8	31				

● Stock item

○ Non Stock item

△ Special order

HELICAL MILLING CUTTERS

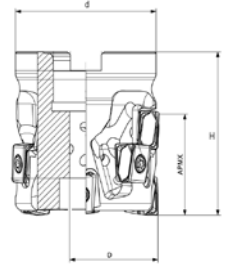

Order Code	Stock Availability	D (mm)		H (mm)	d (mm)	Row	Total Insert	APMX	Insert	Screw	Torx Key	Clamping Screw
MCE040-02/06-LN13-C	○	40	2	55	16	3	6	34	LNHU1306..	M4X11.5	T15	M8X40
MCE040-02/08-LN13-C	○	40	2	65	16	4	8	45				M8X4.5
MCE050-03/09-LN13-C	○	50	3	55	22	3	9	34				M10X40
MCE050-03/12-LN13-C	○	50	3	65	22	4	12	45				M10X50
MCE063-04/20-LN13-C	○	63	4	80	27	5	20	56				M12X60
MCE063-04/16-LN13-C	○	63	4	70	27	4	16	45				M12X50
MCE080-05/25-LN13-C	○	80	5	85	32	5	25	56				M16X65

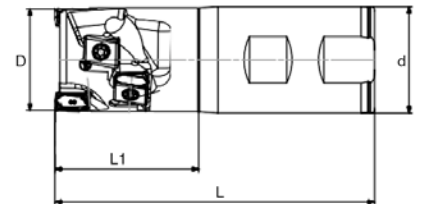

Order Code	Stock Availability	D (mm)		L1 (mm)	L (mm)	d (mm)	Row	Total Insert	APMX	Insert	Screw	Torx Key
MSE040-02/06-LN13-120-C	○	40	2	54	120	40	3	6	34	LNHU1306..	M4X11.5	T15
MSE040-02/08-LN13-135-C	○	40	2	64	135	40	4	8	45			

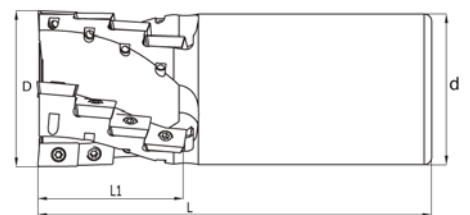

Order Code	Stock Availability	D (mm)		L (mm)	L1 (mm)	d (mm)	Insert	Screw	Torx Key
MSG020-06-AP10-110-C	●	20	6	110	27	20	AP1003..	M2,5X7	T08
MSG025-08-AP10-120-C	●	25	8	120	36	25			
MSG032-15-AP10-120-C	●	32	15	120	45	32			
MSG040-18-AP10-130-C	●	40	18	130	54	32			

● Stock item

○ Non Stock item

△ Special order

Milling

HELICAL MILLING CUTTERS

*The recommended cutting conditions always refer to general conditions. These cutting conditions should be adjusted according to the practical machine rigidity, tools, workpiece clamping and coolant. Average chip thickness (hm)=fz x sinkr.

Materials				Cutting depth and feed					
ISO	Material classification	Tensile strength (N/mm ²)	Hardness (HB)	LNHU 0904..					
				ap		Chipbreaker			
						M4		R2	
				min	max	fz (mm)		fz (mm)	
	Unalloyed steel	<600	<180	3.00	46.00	0.08	0.25	-	-
		<950	<280						
	Alloyed steel	700-950	200-280			0.06	0.20	-	-
		950-1200	280-355						
		1200-1400	355-415						
	Duplex stainless steel	778	230			0.06	0.20	-	-
	Austenitic stainless steel	675	200						
	Precipitation-hardening stainless steel	1013	300						
	Grey cast iron	700	220			0.08	0.28	-	-
	Nodular cast iron	880	260						
	Malleable cast iron	800	250						
	Aluminum	260	75			-	-	0.06	0.25
	Aluminum alloy	447	130						
	Fe-based alloy	943	280			0.08	0.15	-	-
	Co-based alloy	1076	320						
	Ni-based alloy	1177	350						
	Ti-alloy	1262	370						
	Hardened steel	-	50-60HRC						
	Chilled cast iron	-	55HRC	-	-	-	-		

Milling

Materials				Cutting depth and feed					
ISO	Material classification	Tensile strength (N/mm ²)	Hardness (HB)	LNHU 1306					
				ap		Chipbreaker			
						M4		R2	
				min	max	fz (mm)		fz (mm)	
	Unalloyed steel	<600	<180	3.00	46.00	0.08	0.25	0.08	0.28
		<950	<280						
	Alloyed steel	700-950	200-280			0.06	0.20	0.06	0.22
		950-1200	280-355						
		1200-1400	355-415						
	Duplex stainless steel	778	230			0.06	0.20	0.06	0.22
	Austenitic stainless steel	675	200						
	Precipitation-hardening stainless steel	1013	300						
	Grey cast iron	700	220			0.08	0.28	0.08	0.30
	Nodular cast iron	880	260						
	Malleable cast iron	800	250						
	Aluminum	260	75			-	-	-	-
	Aluminum alloy	447	130						
	Fe-based alloy	943	280			0.08	0.15	-	-
	Co-based alloy	1076	320						
	Ni-based alloy	1177	350						
	Ti-alloy	1262	370						
	Hardened steel	-	50-60HRC						
	Chilled cast iron	-	55HRC	-	-	-	-		

SCREW TYPE ENDMILLS

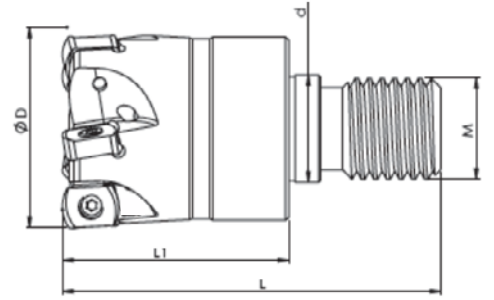

Order Code	Stock Availability	D (mm)		L1 (mm)	L(mm)	d(mm)	M(mm)	Insert	Screw	Torx Key
MTT020-03-BL06-M10-C	●	20	3	36	60	10,5	M10	BLXP06T3..	SM2,5X8	T08
MTT025-04-BL06-M12-C	●	25	4	36	60	12,5	M12			
MTT032-05-BL06-M16-C	●	32	5	36	60	17	M16			
MTT040-06-BL06-M16-C	●	40	6	36	60	17	M16			
MTT042-06-BL06-M16-C	●	42	6	36	60	17	M16			

Milling

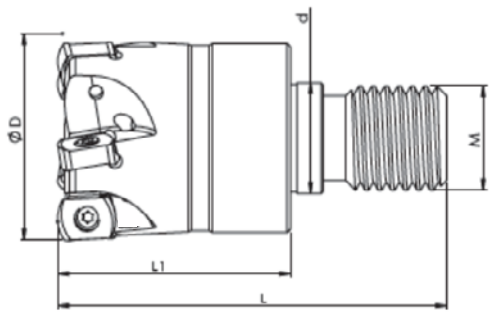

Order Code	Stock Availability	D (mm)		L1 (mm)	L(mm)	d(mm)	M(mm)	Insert	Screw	Torx Key
MTY020-03-LN03-M10-C	●	20	3	36	60	10,5	M10	LNGX0303...	SM3X8	T08
MTY025-04-LN03-M12-C	●	25	4	36	60	12,5	M12			
MTY032-05-LN03-M16-C	●	32	5	38	62	17	M16			
MTY035-05-LN03-M16-C	●	35	5	38	62	17	M16			
MTY040-06-LN03-M16-C	●	40	6	40	65	17	M16			
MTY042-06-LN03-M16-C	●	42	6	40	65	17	M16			

● Stock item

○ Non Stock item

△ Special order

SCREW TYPE ENDMILLS

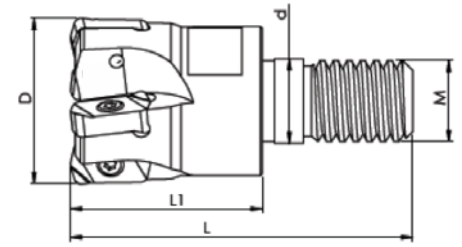

90°



Order Code	Stock Availability	D (mm)		L1 (mm)	L(mm)	d(mm)	M(mm)			
MTU020-03-LN03-M10-C	●	20	3	31	50	10,5	M10	LNET0303..	SM2,5X8	T08
MTU025-04-LN03-M12-C	●	25	4	39	51	12,5	M12			
MTU032-04-LN03-M16-C	●	32	4	39	63	17	M16			
MTU032-05-LN03-M16-C	●	32	5	39	63	17	M16			
MTU035-04-LN03-M16-C	●	35	4	39	63	17	M16			
MTU040-06-LN03-M16-C	●	40	6	39	63	17	M16			
MTU042-05-LN03-M16-C	●	42	5	39	63	17	M16			
MTU042-06-LN03-M16-C	●	42	6	39	63	17	M16			

Milling

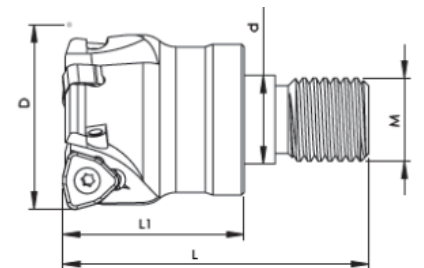

14°



Order Code	Stock Availability	D (mm)		L1 (mm)	L(mm)	d(mm)	M(mm)			
MTK025-02-WN09-M12-C	●	25	2	28	50	12,5	M12	WNGX09T3..	SM3X10	T10
MTK032-03-WN09-M16-C	●	32	3	38	60	17	M16			
MTK035-04-WN09-M16-C	●	35	4	38	60	17	M16			
MTK040-04-WN09-M16-C	●	40	4	38	60	17	M16			
MTK042-04-WN09-M16-C	●	42	4	36	60	17	M16			

● Stock item

○ Non Stock item

△ Special order

SCREW TYPE ENDMILLS

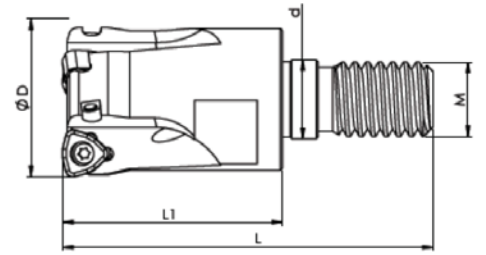

WNGX0603...	SM2,5X8	T08

Order Code	Stock Availability	D (mm)		L1 (mm)	L(mm)	d(mm)	M(mm)
MTK016-02-WN06-M08	●	16	2	25	42	8,5	M8
MTK020-03-WN06-M10	●	20	3	35	60	10,5	M10
MTK025-03-WN06-M12	●	25	3	35	60	12,5	M12
MTK025-04-WN06-M12	●	25	4	35	60	12,5	M12
MTK032-05-WN06-M16	●	32	5	35	60	17	M16
MTK035-05-WN06-M16	●	35	5	35	60	17	M16

Milling

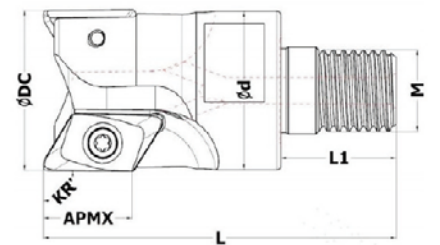

XEKT19...	SM4X10	T15

Order Code	Stock Availability	D (mm)		L1 (mm)	L(mm)	d(mm)	M(mm)	APMX
MTK025-02-XE19-M12-C	○	25	2	22	68	23	M12	17
MTK032-02-XE19-M16-C	○	32	2	23	70	31	M16	17
MTK040-03-XE19-M16-C	○	40	3	23	72	32	M16	17

● Stock item

○ Non Stock item

△ Special order

SCREW TYPE ENDMILLS

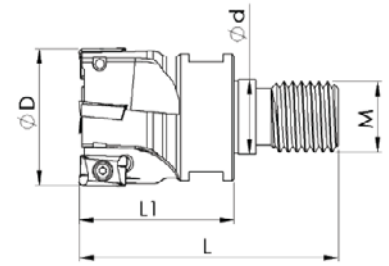

90°



Order Code	Stock Availability	D (mm)		L1 (mm)	L(mm)	d(mm)	M(mm)	Insert	Screw	Torx Key
MTG016-02-AP10-M08-C	●	16	2	33	50	8,5	M08	APKT1003...	M2,5X7	T06
MTG020-03-AP10-M10-C	●	20	3	32	51	10,5	M10			
MTG025-03-AP10-M12-C	●	25	3	38	60	12,5	M12			
MTG032-04-AP10-M16-C	●	32	4	36	60	17	M16			
MTG035-04-AP10-M16-C	●	35	4	36	60	17	M16			
MTG040-05-AP10-M16-C	●	40	5	36	60	17	M16			
MTG025-02-AP16-M12-C	●	25	2	38	60	12,5	M12	APKT1604...	M3,5X8	T15
MTG032-03-AP16-M16-C	●	32	3	44	68	17	M16			
MTG040-04-AP16-M16	●	40	4	44	68	17	M16			

Milling

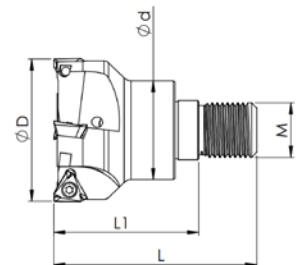

90°

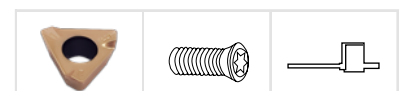

Order Code	Stock Availability	D (mm)		L1 (mm)	L(mm)	d(mm)	M(mm)	Insert	Screw	Torx Key
MTT032-04-3PKT10-M16	●	32	4	36	60	17	M16	3PKT1004...	M3X8	T10
MTT042-04-3PKT10-M16	●	42	4	36	60	17	M16			

● Stock item

○ Non Stock item

△ Special order

SCREW TYPE ENDMILLS

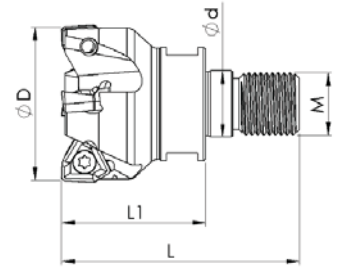

Order Code	Stock Availability	D (mm)		L1 (mm)	L(mm)	d(mm)	M(mm)	Insert	Screw	Torx Key
MTT021-03-SN06-M10-C	●	21	3	31	50	17	M10			
MTT026-03-SN06-M12-C	●	26	3	28	50	12,5	M12	SNKT0603...	M3X8	T10
MTT032-04-SN06-M16-C	●	32	4	36	60	17	M16			

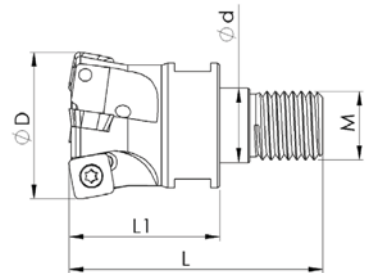

Order Code	Stock Availability	D (mm)		L1 (mm)	L(mm)	d(mm)	M(mm)	Insert	Screw	Torx Key
MTZ025-02-SD09-M12-C	●	25	2	28	50	12,5	M12			
MTZ025-03-SD09-M12-C	●	25	3	28	50	12,5	M12			
MTZ032-03-SD09-M16-C	●	32	3	36	60	17	M16	SDMT09T3...	M3,5X8	T15
MTZ035-04-SD09-M16-C	●	35	4	36	60	17	M16			
MTZ040-04-SD09-M16-C	●	40	4	36	60	17	M16			
MTZ042-04-SD09-M16-C	●	42	4	36	60	17	M16			

Milling

● Stock item

○ Non Stock item

△ Special order

SCREW TYPE ENDMILLS

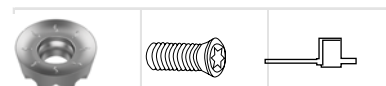
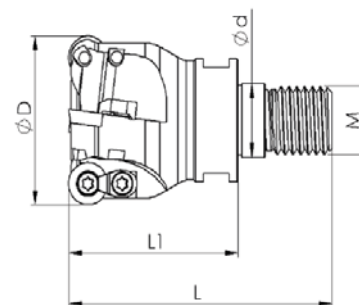

Order Code	Stock Availability	D (mm)		L1 (mm)	L(mm)	d(mm)	M(mm)	Insert	Screw	Torx Key
MTE015-03-RP10-M12-C	○	15	3	35	57	12.5	M12	RPHX10T3...	M3X7.2	T09
MTE022-04-RP10-M16-C	○	22	4	43	67	17	M16			

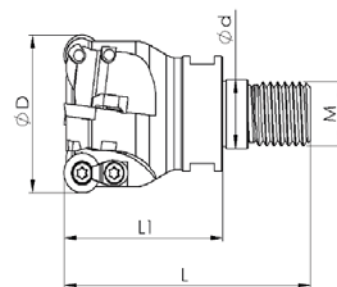

Order Code	Stock Availability	D (mm)		L1 (mm)	L(mm)	d(mm)	M(mm)	Insert	Screw	Torx Key
MTE040-04-RP12-M16-C	○	40	4	43	67	17	M16	RPHX1204...	M4X8.5	T10

Milling

Screw-on Arbor



Order Code	Stock Availability	D (mm)	d (mm)	M (mm)	L (mm)	I (mm)
ET D15 C16 M08 L120-H	●	15	16	8	120	40
ET D18 C20 M10 L120-H	●	18	20	10	120	60
ET D18 C20 M10 L170-H	●	18	20	10	170	90
ET D24 C25 M12 L160-H	●	24	25	12	160	80
ET D24 C25 M12 L200-H	●	24	25	12	200	100
ET D24 C25 M12 L250-H	●	24	25	12	250	150
ET D31 C32 M16 L160-H	●	31	32	16	160	80
ET D31 C32 M16 L200-H	●	31	32	16	200	100
ET D31 C32 M16 L250-H	●	31	32	16	250	150

● Stock item

○ Non Stock item

△ Special order

Engineered for Excellence.

#EuroloyExcellence



Italy Office



Via Leonardo Da Vinci, 4 – 20054
Milano MI ITALIA



(+39) 0282398309



info@euroloy.com

Turkey Office



Üsküdar Cad. YEDPA No:1
Ataşehir -İstanbul -TÜRKİYE



(+90) 850 933 3408



euroloytr@euroloy.com



euroloytools



Euroloy Cutting Tools