

THREADING

2026 | CATALOG

www.euroloy.com

 **EURLOY**
CARBIDE TOOLS

TABLE OF Contents

Technical Information	F3
Partial Profile Threading Inserts	F9
Full Profile Threading Inserts-ISO Metric	F11
Full Profile Threading Inserts-Whitworth	F13
Full Profile Threading Inserts-Trapez	F15
Full Profile Threading Inserts-NPT	F16
Full Profile Threading Inserts-NPTF	F17
Full Profile Threading Inserts-UN	F18
Full Profile Threading Inserts-UNJ	F20
Full Profile Threading Inserts-BSPT	F21
Full Profile Threading Inserts-Round DIN405	F22
Threading Inserts with Chipbreakers	F23
V Type Partial Profile	F23
Full Profile Threading Inserts-API	F24
External Threading Holders	F25
Internal Threading Holders	F26
V Type Holders	F27

THREADING INSERTS

Advantages

Superior Substrate Quality: Produced from micro-grain carbide with advanced PVD coating to resist flank wear and built-up edge.

Precision-Ground Profiles: Guaranteed thread accuracy for ISO, UN, Withworth and NPT standards ensuring perfect thread every time.

Optimized Chip Breakers: Unique geometries designed to manage chip flow effectively.

Maximum Versatility: A comprehensive range of pitch sizes and general grade optimized for both internal and external threading operations for a wide range of materials.

TP2630 Grades – Technical Specifications

Normal wear on inclined surface and corner radius

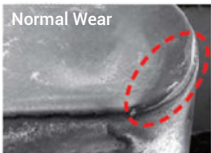

Normal Wear

Euroloy (TP2630 grade)

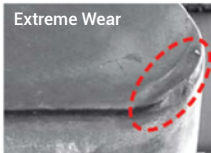

Extreme Wear

Competitor

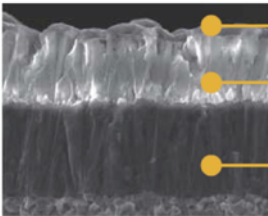

Picture of Coating

- Excellent Titanium layer that prevents wear and provides lubricity to the chip with its excellent friction resistance.
- Customized Aluminum layer for thermal resistance.
- Titanium Layer Developed for Enhanced Crack Resistance.

TP1630-TP4630 Grades - Technical Specifications

Enhanced wear resistance to chip boiling and Alumina layer for better level quality.

Titanium Layer Developed for Enhanced Crack Resistance.

Scaling resistance and improved abrasion resistance on curved surface

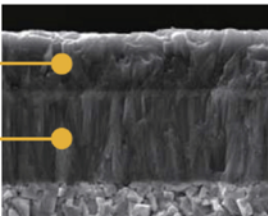

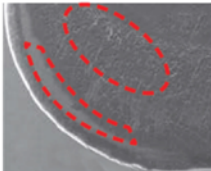

Normal wear on flank

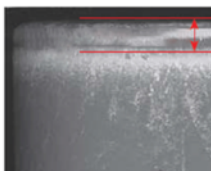

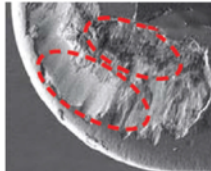

Competing Products

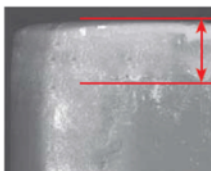

Competing Products

Recommended Grades Per Workpiece

Workpiece					
P	Carbon steel, alloy steel, cast iron	TP1630	TP2630	TP4625	TP4630
M	Cast iron, aluminum, cast steel, titanium alloy steel, heat-resistant steel, copper	TP1630	TP2630	TP4625	TP4630
K	Cast iron, aluminum, cast steel, copper	TP1630	TP2630	TP4625	TP4630

THREADING INSERTS

Product Features

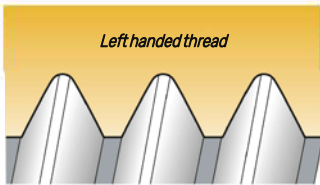
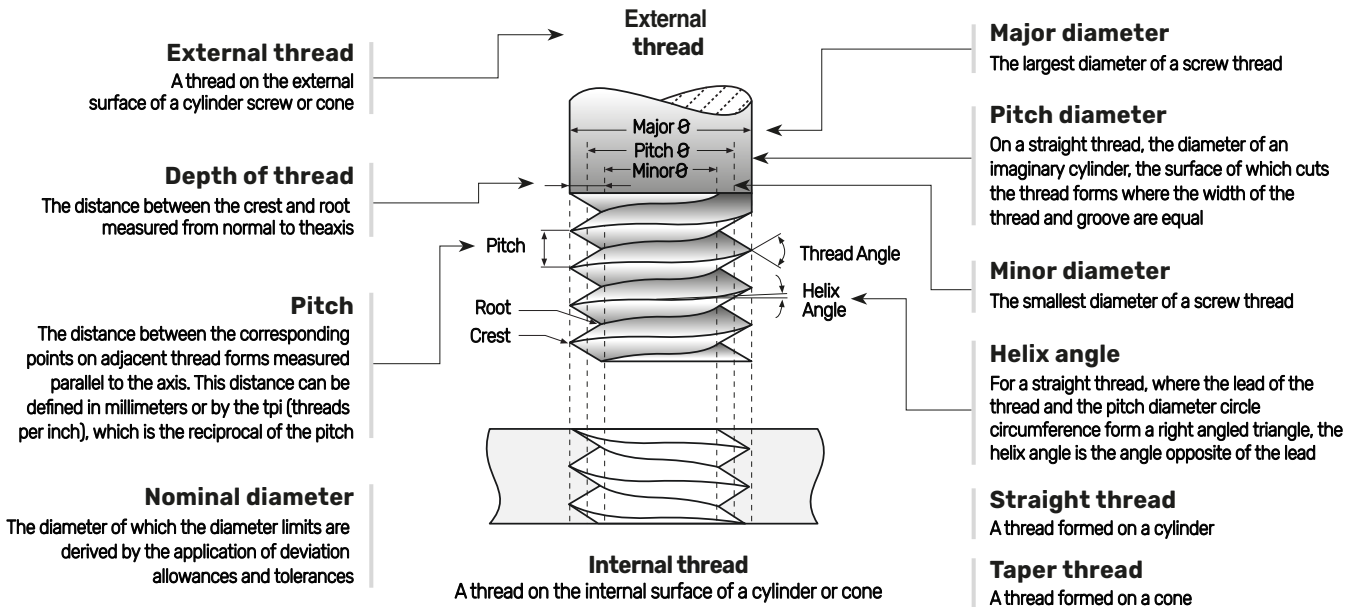

A thread which, when viewed axially, winds in a counter clockwise and receding direction. All left handed threads are designated LH.

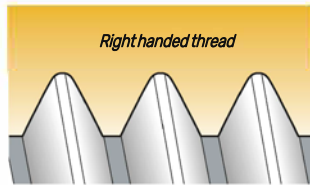

A thread which, when viewed axially, winds in a clockwise and receding direction. Threads are always right handed unless they are specified.

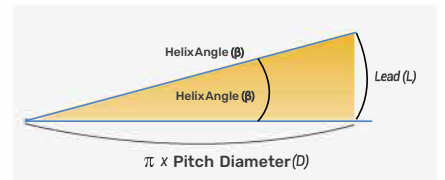

For a straight thread, where the lead of the thread and the pitch diameter circle circumference form a right angled triangle, the helix angle is the angle opposite of the lead.

Machining a Multi-Start Thread

- A thread in which the lead is an integral multiple, greater than one, of the pitch. A multi-start thread permits a more rapid advance without a coarser (larger) thread form.

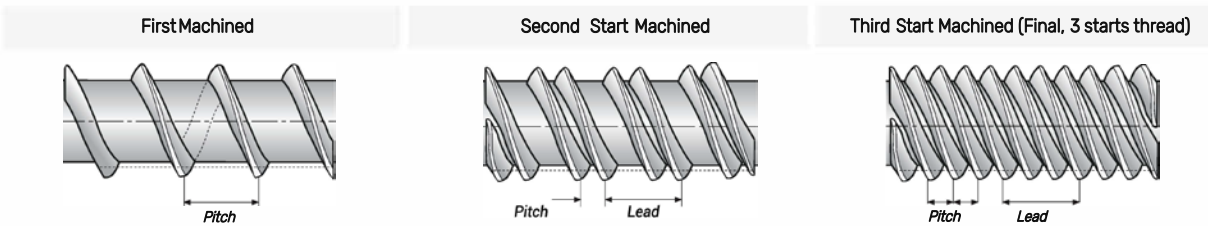

Insert Profile Style

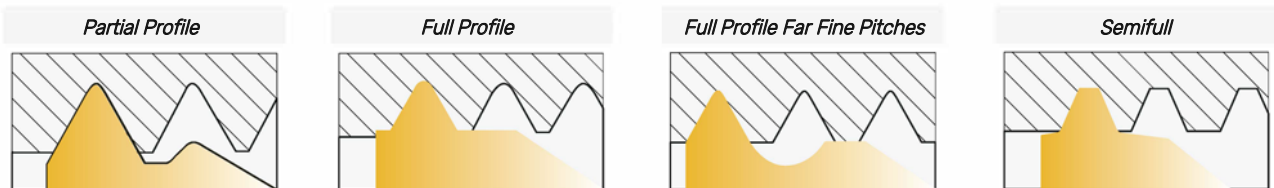

The V partial profile insert cuts without topping the outer diameter of the thread. The same insert can be used for a range of different thread pitches which have a common thread angle.

The full profile insert with form a complete thread profile including the crest. For every thread pitch and standard, a separate insert is required.

The full profile for Fine Pitches with form a complete thread. The topping of the outer diameter is generated by second tooth.

The Semi profile insert with form a complete thread including crest radius but without topping the outer diameter. Mainly used for trapezoidal profiles.

THREADING INSERTS

Method of Thread Turning

Thread	Inserts & Tool Holder	Rotation	Feed Direction	Helix Method	Drawing No
Right Hand External	EX RH	Counter Clockwise	Towards Chuck	Regular	1
	EX LH	Clockwise	From Chuck	Reversed	2
Right Hand Internal	IN LH	Counter Clockwise	Towards Chuck	Regular	3
	IN LH	Clockwise	From Chuck	Reversed	4
Left Hand External	EX LH	Clockwise	Towards Chuck	Regular	5
	EX RH	Counter Clockwise	From Chuck	Reversed	6
Left Hand Internal	IN LH	Clockwise	Towards Chuck	Regular	7
	IN RH	Counter Clockwise	From Chuck	Reversed	8

External RH Thread

External LH Thread

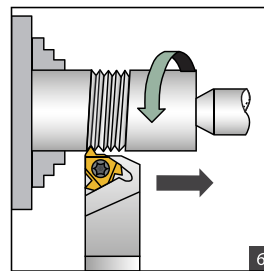
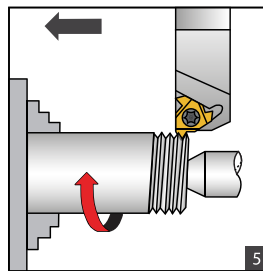
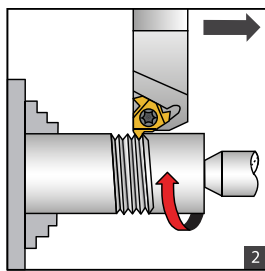
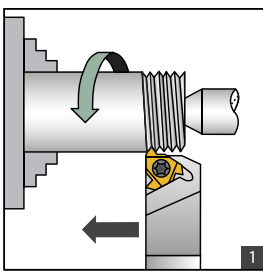

Internal RH Thread

Internal LH Thread

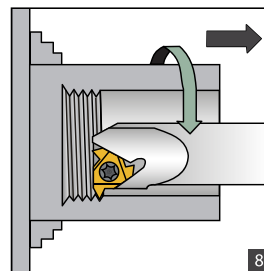
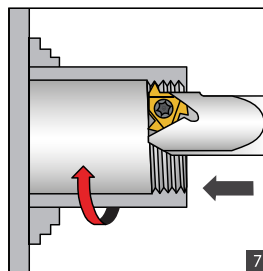
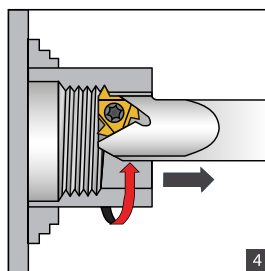
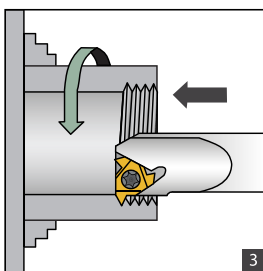

Threading

THREADING INSERTS

Calculating the Helix Angle (β)

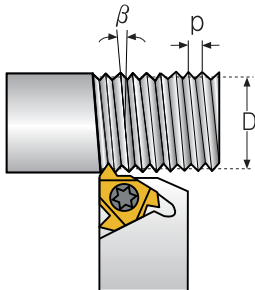

The helix angle is calculated by the following formula:

$$\beta = \tan^{-1} \frac{P \times N}{\pi \times D}$$

β : Helix angle ($^{\circ}$)

P: Pitch (mm)

N: No. of starts

D: Pitch diameter (mm)

Lead = P x N

The helix angle can also be found from the diagram below.

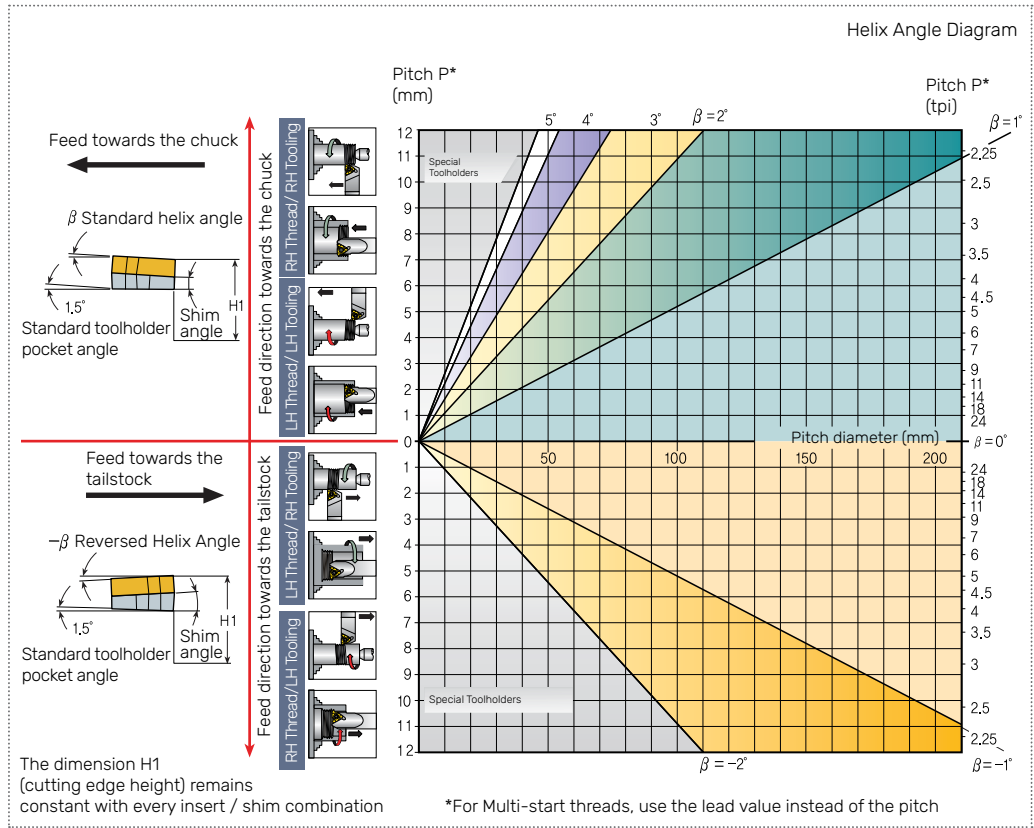

Thread Infeed Method

Infeed	Application
<p>Radial Infeed</p>	<p>When the pitch is smaller than 16 tpi For material with short chips For work with hardened material</p> <p>Radial infeed is the simplest and quickest method. The feed is perpendicular to the turning axis, and both flanks of the insert perform the cutting operation. Radial infeed is recommended in 3 cases.</p>
<p>Flank Infeed (Modified)</p>	<p>When the thread pitch is greater than 16 tpi. Using the radial method, the effective cutting edge length is too large, resulting in chatter. For TRAPEZ and ACME, the radial method results in three cutting edges, making chip flow very difficult.</p> <p>Flank infeed is recommended in the following cases.</p>
<p>Alternate Flank Infeed</p>	<p>This method divides the load equally on both flanks, resulting in equal wear along the cutting edges. Alternate flank infeed requires more complicated programming and is not available on all lathes.</p> <p>Use of the alternate flank method is recommended especially in large pitches and for materials with long chips.</p>

Threading

THREADING INSERTS

Shim

Standard Shim			Helix Angle 1.5°	Insert Size	d	9.525	12.7	15.875	
					L	16	22	27	
	Holder			TER/L	TIR/L	TER/L	TIR/L	TER/L	TIR/L
	Ordering Code			EE16	EI16	EE22	EI22	EE27	EI27
	EE(External)	EI(Internal)							

Application Grade

Grade	Category	Features	Available Insert Type
TP2630 TP1630 TP4630	General Grade for threading inserts	Threading grade designed for general steel applications with high toughness and stable cutting performance.	ER/IR
TP4625	Specialized general grade for threading inserts	Threading grade providing high wear resistance and long tool life in steel applications with stable cutting performance.	ERT/IRT

Number of Passes

Pitch	mm	0.50	0.75	1.00	1.25	1.50	1.75	2.00	2.50	3.00	3.50	4.00	4.50	5.00	5.50	6.00	8.00
	tpi	48	32	24	20	16	14	12	10	8	7	6	5.5	5	4.5	4	3
No.Of Passes		4-6	4-7	4-8	5-9	6-10	7-12	7-12	8-14	9-16	10-18	11-18	11-19	12-20	12-20	12-20	15-24

One cutting depth is calculated by total cutting depth divided into machining times.

THREADING INSERTS

Recommended Cutting Speed by Workpiece (Vc)

Material		Cutting Speed Vc (m/min)			
		Brinell Hardness (HB)	TP1630 TP2630	TP4625	
P	Carbon Steel	Low Carbon (C=0.1-0.25 %)	125	115-190	110-190
		Medium Carbon (C=0.25-0.55 %)	150	100-175	100-165
		High Carbon (C=0.55-0.85 %)	170	90-155	90-155
	Low Alloy Steel (Alloying Element ≤5%)	Unhardened	180	100-180	100-180
		Hardened	275	75-140	75-140
		Hardened	350	70-135	70-135
	High Alloy Steel (alloying elements >5%)	Annealed	200	80-120	80-120
		Hardened	325	50-100	50-100
	Cast Steel	Low Alloy (Alloying Element <5%)	200	70-130	70-130
		High Alloy (Alloying Element >5%)	225	60-120	60-120
M	Stainless Steel Ferritic	Unhardened	200	70-130	70-130
		Hardened	330	50-95	50-95
	Stainless Steel Austenitic	Austenitic	180	80-120	80-120
		Super Austenitic	200	30-100	30-100
	Stainless Steel Cast Ferritic	Unhardened	200	90-120	90-120
		Hardened	330	65-110	65-110
	Stainless Steel Cast Austenitic	Austenitic	200	85-110	85-110
		Hardened	330	60-100	60-100
K	Malleable Cast Iron	Ferritic (Short Chip)	130	70-120	70-120
		Pearlitic (Long Chip)	230	70-120	70-120
	Gray Cast Iron	Low Tensile Strength	180	70-130	70-130
		High Tensile Strength	260	60-100	60-100
	Ductile Cast Iron	Ferritic	160	125-160	125-160
		Pearlitic	260	90-120	90-120

THREADING INSERTS

External Partial Profile Threading Inserts - 60°

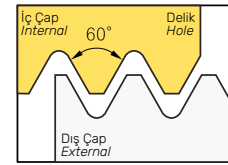
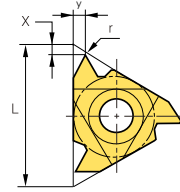
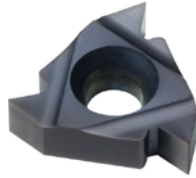

60°													
Insert Shape	Order Code		Stock Availability		Insert Size		Pitch		Size			Shim	Tool Holder
	RH	LH	RH	LH	IC	L(mm)	mm	TPI	r	X	Y		
	11 ER A60	11 EL A60	●	○	1/4"	11	0.5-1.5	48-16	0.05	0.8	0.9	-	TER/L 11 S
	16 ER A60	16 EL A60	○	○	3/8"	16	0.5-1.5	48-16	0.05	0.8	0.9	EE16	TER/L 16 S/C
	16 ER G60	16 EL G60	○	○			1.75-3.0	14-8	0.16	1.2	1.5		
	16 ER AG 60	16 EL AG 60	●	●	0.5-3.0	48-8	0.05	1.2	1.5				
	22 ER N60	22 EL N60	●	○	1/2"	22	3.5-5.0	7-5	0.3	1.7	2.5	EE22	TER/L 22 S/C
	27 ER Q60	27 EL Q60	○	○	5/8"	27	5.5-6.0	4.5-4	0.3	2.3	3.1	EE27	TER/L 27 C

External Partial Profile Threading Inserts - 55°

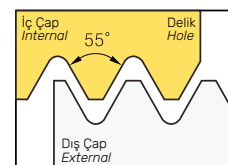
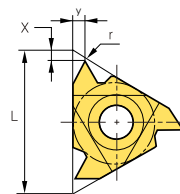
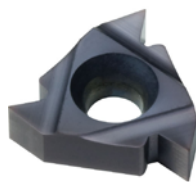

55°													
Insert Shape	Order Code		Stock Availability		Insert Size		Pitch		Size			Shim	Tool Holder
	RH	LH	RH	LH	IC	L(mm)	mm	TPI	r	X	Y		
	11 ER A55	11 EL A55	○	○	1/4"	11	0.5-1.5	48-16	0.05	0.8	0.9	-	TER/L 11 S
	16 ER A55	16 EL A55	○	○	3/8"	16	0.5-1.5	48-16	0.05	0.8	0.9	EE16	TER/L 16 S/C
	16 ER G55	16 EL G55	○	○			1.75-3.0	14-8	0.16	1.2	1.5		
	16 ER AG 55	16 EL AG 55	●	●	0.5-3.0	48-8	0.05	1.2	1.5				
	22 ER N55	22 EL N55	●	○	1/2"	22	3.5-5.0	7-5	0.3	1.7	2.5	EE22	TER/L 22 S/C
	27 ER Q55	27 EL Q55	○	○	5/8"	27	5.5-6.0	4.5-4	0.3	2	2.9	EE27	TER/L 27 C

• Stock ○ Non Stock Item

THREADING INSERTS

Internal Partial Profile Threading Inserts - 60°

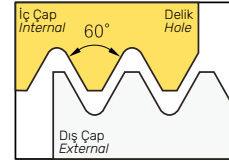
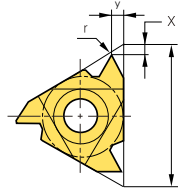
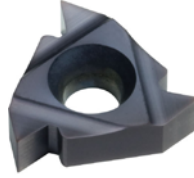

60°													
Insert Shape	Order Code		Stock Availability		Insert Size		Pitch		Size			Shim	Tool Holder
	RH	LH	RH	LH	IC	L(mm)	mm	TPI	r	X	Y		
	8 IR A60	8 IL A60	●	○	3/16"	8	0.5-1.5	48-16	0.05	0.6	0.6	-	TIR/L 8 S
	11 IR A60	11 IL A60	●	○	1/4"	11	0.5-1.5	48-16	0.05	0.8	0.9	-	TIR/L 11 S
	16 IR A60	16 IL A60	○	○	3/8"	16	0.5-1.5	48-16	0.05	0.8	0.9	E116	TIR/L 16 S/C
	16 IR G60	A6 IL G60	○	○			1.75-3.0	14-8	0.16	1.2	1.5		
	16 IR AG60	16 IL AG60	●	●	0.5-3.0	48-8	0.05	1.2	1.5	E122	TIR/L 22 S/C		
	22 IR N60	22 IL N60	●	○	1/2"	22	3.5-5.0	7-5	0.3			1.7	2.5
	27 IR Q60	27 IL Q60	○	○	5/8"	27	5.5-6.0	4.5-4.0	0.3	2.3	2.7	E127	TIR/L 27 C

Internal Partial Profile Threading Inserts - 55°

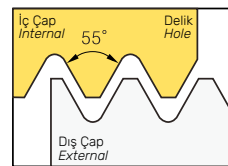
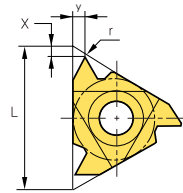
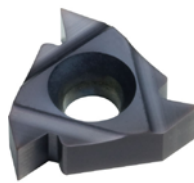

55°													
Insert Shape	Order Code		Stock Availability		Insert Size		Pitch		Size			Shim	Tool Holder
	RH	LH	RH	LH	IC	L(mm)	mm	TPI	r	X	Y		
	8 IR A55	8 IL A55	●	○	3/16"	8	0.5-1.5	48-16	0.05	0.6	0.6	-	TIR/L 8 S
	11 IR A55	11 IL A55	●	○	1/4"	11	0.5-1.5	48-16	0.05	0.8	0.9	-	TIR/L 11 S
	16 IR A55	16 IL A55	○	○	3/8"	16	0.5-1.5	48-16	0.05	0.8	0.9	E116	TIR/L 16 S/C
	16 IR G55	16 IL G55	○	○			1.75-3.0	14-8	0.16	1.2	1.5		
	16 IR AG55	16 IL AG55	●	●	0.5-3.0	48-8	0.05	1.2	1.5	E122	TIR/L 22 S/C		
	22 IR N55	22 IL N55	●	○	1/2"	22	3.5-5.0	7-5	0.3			1.7	2.5
	27 IR Q55	27 IL Q55	○	○	5/8"	27	5.5-6.0	4.5-4.0	0.3	2	2.9	E127	TIR/L 27 C

● Stock ○ Non Stock Item

THREADING INSERTS

External Full Profile Threading Inserts - ISO Metric

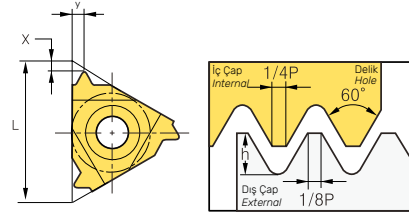
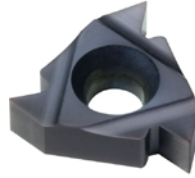

Insert Shape	Order Code		Stock Availability		Insert Size L(mm)	Pitch mm	Size			Shim	Tool Holder
	RH	LH	RH	LH			hmin	X	Y		
	11 ER 0.50 ISO	11 EL 0.50 ISO	○	○	11	0.50	0.31	0.60	0.40	-	TER/L 11 S
	11 ER 0.60 ISO	11 EL 0.60 ISO	○	○		0.60	0.37	0.60	0.60		
	11 ER 0.70 ISO	11 EL 0.70 ISO	○	○		0.70	0.43	0.60	0.60		
	11 ER 0.75 ISO	11 EL 0.75 ISO	○	○		0.75	0.46	0.60	0.60		
	11 ER 0.80 ISO	11 EL 0.80 ISO	○	○		0.80	0.49	0.60	0.60		
	11 ER 1.00 ISO	11 EL 1.00 ISO	●	○		1.00	0.61	0.70	0.70		
	11 ER 1.25 ISO	11 EL 1.25 ISO	○	○		1.25	0.77	0.80	0.90		
	11 ER 1.50 ISO	11 EL 1.50 ISO	●	○		1.50	0.92	0.80	1.00		
	11 ER 1.75 ISO	11 EL 1.75 ISO	○	○		1.75	1.07	0.80	1.10		
	16 ER 0.50 ISO	16 EL 0.50 ISO	●	●	16	0.50	0.31	0.60	0.40	EE16	TER/L 16 S/C
	16 ER 0.60 ISO	16 EL 0.60 ISO	○	○		0.60	0.37	0.60	0.60		
	16 ER 0.70 ISO	16 EL 0.70 ISO	●	○		0.70	0.43	0.60	0.60		
	16 ER 0.75 ISO	16 EL 0.75 ISO	●	●		0.75	0.46	0.60	0.60		
	16 ER 0.80 ISO	16 EL 0.80 ISO	●	○		0.80	0.49	0.60	0.60		
	16 ER 1.00 ISO	16 EL 1.00 ISO	●	●		1.00	0.61	0.70	0.70		
	16 ER 1.25 ISO	16 EL 1.25 ISO	●	●		1.25	0.77	0.80	0.90		
	16 ER 1.50 ISO	16 EL 1.50 ISO	●	●		1.50	0.92	0.80	1.00		
	16 ER 1.75 ISO	16 EL 1.75 ISO	●	●		1.75	1.07	0.9	1.2		
	16 ER 2.00 ISO	16 EL 2.00 ISO	●	●		2.00	1.23	1.00	1.30		
	16 ER 2.50 ISO	16 EL 2.50 ISO	○	●	2.50	1.53	1.10	1.50			
	16 ER 3.00 ISO	16 EL 3.00 ISO	●	●	3.00	1.84	1.20	1.60			
	16 ER 3.50 ISO	16 EL 3.50 ISO	●	○	3.5	2.15	1,6	2,3			
	22 ER 3.50 ISO	22 EL 3.50 ISO	●	○	22	3.50	2.15	1.60	2.30	EE22	TER/L 22 S
	22 ER 4.00 ISO	22 EL 4.00 ISO	●	○		4.00	2.45	1.60	2.30		
	22 ER 4.50 ISO	22 EL 4.50 ISO	○	○		4.50	2.76	1.70	2.40		
	22 ER 5.00 ISO	22 EL 5.00 ISO	●	○		5.00	3.07	1.70	2.50		
	22 ER 6.00 ISO	22 EL 6.00 ISO	●	○		6.0	3.68	2.0	2.90		
27 ER 5.50 ISO	27 EL 5.50 ISO	○	○	27	5.50	3.37	1.90	2.70	EE27	TER/L 27 S	
27 ER 6.00 ISO	27 EL 6.00 ISO	○	○		6.00	3.68	2.00	2.90			

• Stock ○ Non Stock Item

THREADING INSERTS

Internal Full Profile Threading Inserts - ISO Metric

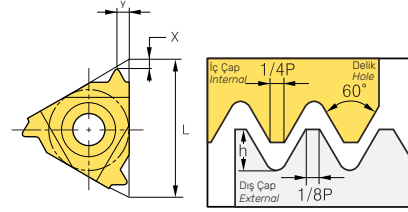
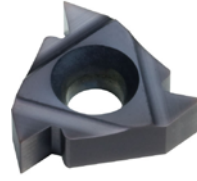

Insert Shape	Order Code		Stock Availability		Insert Size L(mm)	Pitch mm	Size			Shim	Tool Holder
	RH	LH	RH	LH			hmin	X	Y		
	11 IR 0.50 ISO	11 IL 0.50 ISO	●	○	11	0.50	0.29	0.60	0.40	-	TIR/L 11 S
	11 IR 0.60 ISO	11 IL 0.60 ISO	○	○		0.60	0.35	0.60	0.60		
	11 IR 0.70 ISO	11 IL 0.70 ISO	○	○		0.70	0.40	0.60	0.60		
	11 IR 0.75 ISO	11 IL 0.75 ISO	●	○		0.75	0.43	0.60	0.60		
	11 IR 0.80 ISO	11 IL 0.80 ISO	○	○		0.80	0.46	0.60	0.60		
	11 IR 1.00 ISO	11 IL 1.00 ISO	●	○		1.00	0.58	0.70	0.70		
	11 IR 1.25 ISO	11 IL 1.25 ISO	●	○		1.25	0.72	0.80	0.90		
	11 IR 1.50 ISO	11 IL 1.50 ISO	●	○		1.50	0.87	0.80	1.00		
	11 IR 1.75 ISO	11 IL 1.75 ISO	●	○		1.75	1.01	0.90	1.10		
	11 IR 2.00 ISO	11 IL 2.00 ISO	●	○		2.00	1.15	0.90	1.10		
	11 IR 2.50 ISO	11 IL 2.50 ISO	●	○	2.00	1.44	0.80	1.10			
	16 IR 0.50 ISO	16 IL 0.50 ISO	●	●	16	0.50	0.29	0.60	0.40	E116	TIR/L 16 S/C
	16 IR 0.60 ISO	16 IL 0.60 ISO	●	○		0.60	0.35	0.60	0.60		
	16 IR 0.70 ISO	16 IL 0.70 ISO	●	○		0.70	0.40	0.60	0.60		
	16 IR 0.75 ISO	16 IL 0.75 ISO	●	●		0.75	0.43	0.60	0.60		
	16 IR 0.80 ISO	16 IL 0.80 ISO	●	○		0.80	0.46	0.60	0.60		
	16 IR 1.00 ISO	16 IL 1.00 ISO	●	●		1.00	0.58	0.60	0.70		
	16 IR 1.25 ISO	16 IL 1.25 ISO	●	●		1.25	0.72	0.80	0.90		
	16 IR 1.50 ISO	16 IL 1.50 ISO	●	●		1.50	0.87	0.80	1.00		
	16 IR 1.75 ISO	16 IL 1.75 ISO	●	●		1.75	1.01	0.90	1.20		
16 IR 2.00 ISO	16 IL 2.00 ISO	●	●	2.00		1.15	1.00	1.30			
16 IR 2.50 ISO	16 IL 2.50 ISO	●	●	2.50	1.44	1.10	1.50				
16 IR 3.00 ISO	16 IL 3.00 ISO	●	●	3.00	1.73	1.10	1.50				
16 IR 3.50 ISO	16 IL 3.50 ISO	●	○	3.50	2.02	1.6	2.3				
22 IR 3.50 ISO	22 IL 3.50 ISO	●	○	22	3.50	2.02	1.60	2.30	E122	TIR/L 22 S	
22 IR 4.00 ISO	22 IL 4.00 ISO	●	○		4.00	2.31	1.60	2.30			
22 IR 4.50 ISO	22 IL 4.50 ISO	●	○		4.50	2.60	1.60	2.40			
22 IR 5.00 ISO	22 IL 5.00 ISO	●	○		5.00	2.89	1.60	2.30			
22 IR 5.50 ISO	22 IL 5.50 ISO	○	○		5.50	3.17	1.60	2.30			
22 IR 6.00 ISO	22 IL 6.00 ISO	●	○	6.00	3.46	2.0	2.9				
27 IR 5.50 ISO	27 IL 5.50 ISO	○	○	27	5.50	3.17	1.60	2.30	E127	TIR/L 27 S	
27 IR 6.00 ISO	27 IL 6.00 ISO	○	○		6.00	3.46	1.80	2.50			

THREADING INSERTS

External Full Profile Threading Insert - **Whitworth**

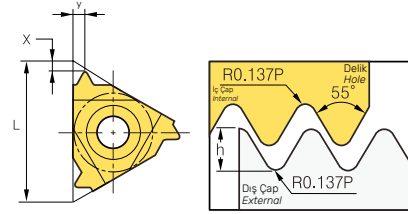
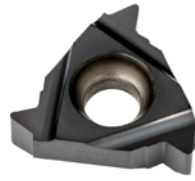

Insert Shape	Order Code		Stock Availability		Insert Size L(mm)	Pitch TPI	Size			Shim	Tool Holder
	RH	LH	RH	LH			hmin	X	Y		
	11 ER 28 W	11 EL 28 W	o	o	11	28	0.58	0.60	0.70	-	TER/L 11 S/C
	11 ER 26 W	11 EL 26 W	o	o		26	0.63	0.70	0.80		
	11 ER 20 W	11 EL 20 W	o	o		20	0.81	0.80	0.90		
	11 ER 19 W	11 EL 19 W	o	o		19	0.86	0.80	1.00		
	11 ER 18 W	11 EL 18 W	o	o		18	0.90	0.80	1.00		
	11 ER 16 W	11 EL 16 W	o	o		16	1.02	0.90	1.10		
	11 ER 14 W	11 EL 14 W	•	o		14	1.16	1.00	1.20		
	11 ER 11 W	11 EL 11 W	o	o		11		1.0	1.2		
	16 ER 32 W	16 EL 32 W	o	o	16	32	0.51	0.60	0.60	EE16	TER/L 16 S/C
	16 ER 28 W	16 EL 28 W	•	•		28	0.58	0.60	0.70		
	16 ER 26 W	16 EL 26 W	•	•		26	0.63	0.70	0.80		
	16 ER 24 W	16 EL 24 W	•	o		24	0.68	0.70	0.80		
	16 ER 20 W	16 EL 20 W	•	•		20	0.81	0.80	0.90		
	16 ER 19 W	16 EL 19 W	•	•		19	0.86	0.80	1.00		
	16 ER 18 W	16 EL 18 W	•	•		18	0.90	0.80	1.00		
	16 ER 16 W	16 EL 16 W	o	•		16	1.02	0.90	1.10		
	16 ER 14 W	16 EL 14 W	•	•		14	1.16	1.00	1.20		
	16 ER 12 W	16 EL 12 W	•	•		12	1.36	1.10	1.40		
	16 ER 11 W	16 EL 11 W	•	•		11	1.48	1.10	1.50		
	16 ER 10 W	16 EL 10 W	•	•		10	1.63	1.10	1.50		
	16 ER 9 W	16 EL 9 W	•	•	9	1.81	1.20	1.70			
	16 ER 8 W	16 EL 8 W	•	•	8	2.03	1.20	1.50			
	22 ER 7 W	22 EL 7 W	o	o	22	7.00	2.41	1.60	2.30	EE22	TER/L 22 S
	22 ER 6 W	22 EL 6 W	o	o		6.00	2.71	1.60	2.30		
	22 ER 5 W	22 EL 5 W	o	o		5.00	3.25	1.70	2.40		
	27 ER 4,5 W	27 EL 4,5 W	o	o	27	4.50	3.61	1.80	2.60	EE27	TER/L 27 S
	27 ER 4 W	27 EL 4 W	o	o		4.00	4.07	2.00	2.90		

• Stock o Non Stock Item

THREADING INSERTS

Internal Full Profile Threading Insert - **Whitworth**

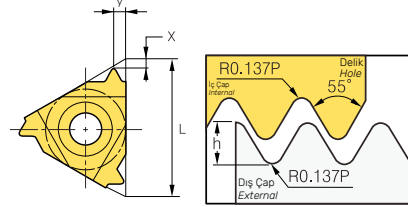
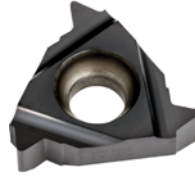

Insert Shape	Order Code		Stock Availability		Insert Size	Pitch	Size			Shim	Tool Holder
	RH	LH	RH	LH			L(mm)	TPI	hmin		
	11 IR 28 W	11 IL 28 W	●	○	11	28	0.58	0.60	0.70	-	TIR/L 11 S/C
	11 IR 26 W	11 IL 26 W	●	○		26	0.63	0.70	0.80		
	11 IR 20 W	11 IL 20 W	●	○		20	0.81	0.80	0.90		
	11 IR 19 W	11 IL 19 W	●	○		19	0.86	0.80	1.00		
	11 IR 18 W	11 IL 18 W	●	○		18	0.90	0.80	1.00		
	11 IR 16 W	11 IL 16 W	●	○		16	1.02	0.90	1.10		
	11 IR 14 W	11 IL 14 W	●	○		14	1.16	1.00	1.20		
	11 IR 11 W	11 IL 11 W	●	○		11		1.0	1.2		
	16 IR 32 W	16 IL 32 W	○	○	16	32	0.51	0.60	0.60	E116	TIR/L 16 S/C
	16 IR 28 W	16 IL 28 W	●	●		28	0.58	0.60	0.70		
	16 IR 26 W	16 IL 26 W	●	●		26	0.63	0.70	0.80		
	16 IR 24 W	16 IL 24 W	●	○		24	0.68	0.70	0.80		
	16 IR 20 W	16 IL 20 W	●	●		20	0.81	0.80	0.90		
	16 IR 19 W	16 IL 19 W	●	●		19	0.86	0.80	1.00		
	16 IR 18 W	16 IL 18 W	●	●		18	0.90	0.80	1.00		
	16 IR 16 W	16 IL 16 W	●	●		16	1.02	0.90	1.10		
	16 IR 14 W	16 IL 14 W	●	●		14	1.16	1.00	1.20		
	16 IR 12 W	16 IL 12 W	●	●		12	1.36	1.10	1.40		
	16 IR 11 W	16 IL 11 W	●	●	22	11	1.48	1.10	1.50	E122	TIR/L 22 C
	16 IR 10 W	16 IL 10 W	●	●		10	1.63	1.10	1.50		
	16 IR 9 W	16 IL 9 W	○	●		9	1.81	1.20	1.70		
	16 IR 8 W	16 IL 8 W	●	●		8	2.03	1.20	1.50		
	22 IR 7 W	22 IL 7 W	●	○	27	7.00	2.41	1.60	2.30	E127	TIR/L 27 C
	22 IR 6 W	22 IL 6 W	●	○		6.00	2.71	1.60	2.30		
	22 IR 5 W	22 IL 5 W	●	○		5.00	3.25	1.70	2.40		
	27 IR 4,5 W	27 IL 4,5 W	○	○		4.50	3.61	1.80	2.60		
27 IR 4 W	27 IL 4 W	○	○	4.00	4.07	2.00	2.90				

Threading

THREADING INSERTS

External Full Profile Threading Inserts - Trapez (DIN103)

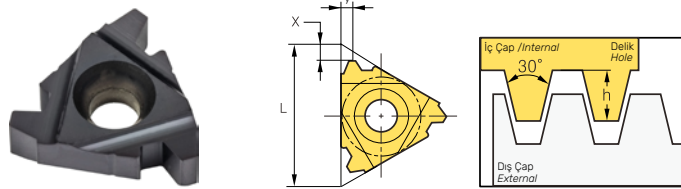

Insert Shape	Order Code		Stock Availability		Insert Size	Pitch	Size			Shim	Tool Holder
	RH	LH	RH	LH			L(mm)	TPI	hmin		
	11 ER 1.5 TR	11 EL 1.5 TR	○	○	11	1.5	0.90	0.80	0.90	-	TER/L 11 S
	16 ER 1.5 TR	16 EL 1.5 TR	●	○	16	1.5	0.90	1.00	1.10	EE16	TER/L 16 S/C
	16 ER 2.0 TR	16 EL 2.0 TR	●	○		2.0	1.25	1.10	1.30		
	16 ER 3.0 TR	16 EL 3.0 TR	●	○		3.0	1.75	1.30	1.50		
	22 ER 4.0 TR	22 EL 4.0 TR	●	○	22	4.0	2.25	1.70	1.90	EE22	TER/L 22 S
	22 ER 5.0 TR	22 EL 5.0 TR	●	○		5.0	2.75	2.10	2.50		
	22 ER 6.0 TR	22 EL 6.0 TR	●	○		6.0	3.50	2.30	2.70		
	27 ER 6.0 TR	27 EL 6.0 TR	●	○	27	6.0	3.50	2.30	2.70	EE27	TER/L 27 S

Internal Full Profile Threading Inserts - Trapez (DIN103)

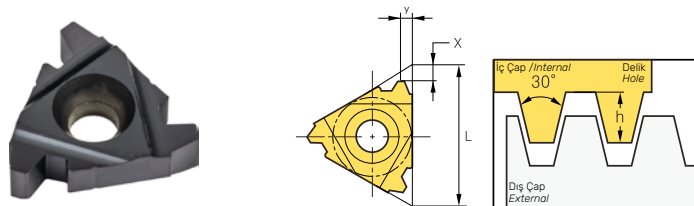

Insert Shape	Order Code		Stock Availability		Insert Size	Pitch	Size			Shim	Tool Holder
	RH	LH	RH	LH			L(mm)	TPI	hmin		
	11 IR 1.5 TR	11 IL 1.5 TR	○	○	11	1.5	0.90	0.80	0.90	-	TIR/L 11 S
	16 IR 1.5 TR	16 IL 1.5 TR	○	○	16	1.5	0.90	1.00	1.10	EI16	TIR/L 16 S/C
	16 IR 2.0 TR	16 IL 2.0 TR	●	○		2.0	1.25	1.10	1.30		
	16 IR 2.50 TR	16 IL 2.50 TR	○	○		2.50	1.53	1.20	1.40		
	16 IR 3.0 TR	16 IL 3.0 TR	●	○	22	3.0	1.75	1.30	1.50	EI22	TIR/L 22 C
	22 IR 4.0 TR	22 IL 4.0 TR	●	○		4.0	2.25	1.70	1.90		
	22 IR 5.0 TR	22 IL 5.0 TR	●	○		5.0	2.75	2.10	2.50		
	22 IR 6.0 TR	22 IL 6.0 TR	●	○	27	6.0	3.50	2.30	2.70	EI27	TIR/L 27 C
27 IR 6.0 TR	27 IL 6.0 TR	●	○	6.0		3.50	2.30	2.70			

● Stock ○ Non Stock Item

THREADING INSERTS

External Full Profile Threading Inserts - NPT

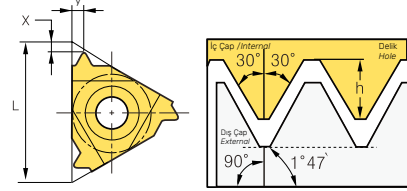
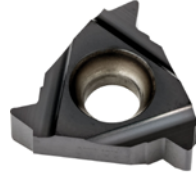

Insert Shape	Order Code		Stock Availability		Insert Size L(mm)	Pitch TPI	Size			Shim	Tool Holder
	RH	LH	RH	LH			hmin	X	Y		
	11 ER 27 NPT	11 EL 27 NPT	○	○	11	27	0.66	0.70	0.80	-	TER/L 11 S
	11 ER 18 NPT	11 EL 18 NPT	○	○		18	1.01	0.80	1.00		
	11 ER 14 NPT	11 EL 14 NPT	○	○		14	1.33	0.80	1.00		
	16 ER 27 NPT	16 EL 27 NP	●	○	16	27	0.66	0.70	0.80	EE16	TER/L 16 S/C
	16 ER 18 NPT	16 EL 18 NPT	●	○		18	1.01	0.80	1.00		
	16 ER 14 NPT	16 EL 14 NPT	●	○		14	1.33	0.90	1.20		
	16 ER 11,5 NPT	16 EL 11,5 NPT	●	○		11,5	1.64	1.10	1.50		
	16 ER 8 NPT	16 EL 8 NPT	○	○		8	2.42	1.30	1.80		

Internal Full Profile Threading Inserts - NPT

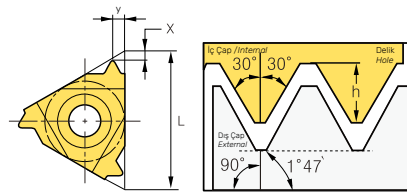
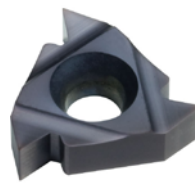

Insert Shape	Order Code		Stock Availability		Insert Size L(mm)	Pitch TPI	Size			Shim	Tool Holder
	RH	LH	RH	LH			hmin	X	Y		
	11 IR 27 NPT	11 IL 27 NPT	●	○	11	27	0.66	0.70	0.80	-	TIR/L 11 S
	11 IR 18 NPT	11 IL 18 NPT	●	○		18	1.01	0.80	1.00		
	11 IR 14 NPT	11 IL 14 NPT	●	○		14	1.33	0.80	1.00		
	16 IR 27 NPT	16 IL 27 NPT	●	○	16	27	0.66	0.70	0.80	E116	TIR/L 16 S/C
	16 IR 18 NPT	16 IL 18 NPT	●	○		18	1.01	0.80	1.00		
	16 IR 14 NPT	16 IL 14 NPT	●	○		14	1.33	0.90	1.20		
	16 IR 11,5 NPT	16 IL 11,5 NPT	●	○		11,5	1.64	1.10	1.50		
	16 IR 8 NPT	16 IL 8 NPT	○	○		8	2.42	1.30	1.80		

● Stock ○ Non Stock Item

THREADING INSERTS

External Full Profile Threading Inserts - NPTF

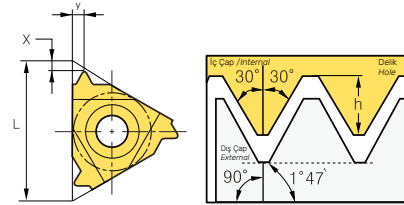
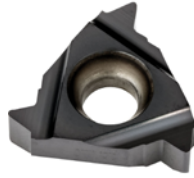

Insert Shape	Order Code		Stock Availability		Insert Size	Pitch	Size			Shim	Tool Holder
	RH	LH	RH	LH			L(mm)	TPI	hmin		
	11 ER 27 NPTF	11 EL 27 NPTF	○	○	11	27	0,66	0,70	0,80	-	TER/L 11 S
	11 ER 18 NPTF	11 EL 18 NPTF	○	○		18	1,01	0,80	1,00		
	11 ER 14 NPTF	11 EL 14 NPTF	○	○		14	1,33	0,80	1,00		
	16 ER 27 NPTF	16 EL 27 NPTF	○	○	16	27	0,66	0,70	0,80	EE16	TER/L 16 S/C
	16 ER 18 NPTF	16 EL 18 NPTF	○	○		18	1,01	0,80	1,00		
	16 ER 14 NPTF	16 EL 14 NPTF	○	○		14	1,33	0,90	1,20		
	16 ER 11,5 NPTF	16 EL 11,5 NPTF	○	○		11,5	1,64	1,10	1,50		
	16 ER 8 NPTF	16 EL 8 NPTF	○	○		8	2,42	1,30	1,80		

Internal Full Profile Threading Inserts - NPTF

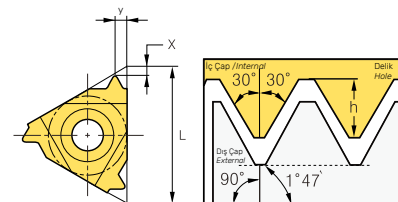
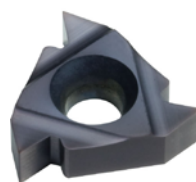

Insert Shape	Order Code		Stock Availability		Insert Size	Pitch	Size			Shim	Tool Holder
	RH	LH	RH	LH			L(mm)	TPI	hMIN		
	11 IR 27 NPTF	11 IL 27 NPTF	○	○	11	27	0,66	0,70	0,80	-	TIR/L 11 S
	11 IR 18 NPTF	11 IL 18 NPTF	○	○		18	1,01	0,80	1,00		
	11 IR 14 NPTF	11 IL 14 NPTF	○	○		14	1,33	0,80	1,00		
	16 IR 27 NPTF	16 IL 27 NPTF	○	○	16	27	0,66	0,70	0,80	E116	TIR/L 16 S/C
	16 IR 18 NPTF	16 IL 18 NPTF	○	○		18	1,01	0,80	1,00		
	16 IR 14 NPTF	16 IL 14 NPTF	○	○		14	1,33	0,90	1,20		
	16 IR 11,5 NPTF	16 IL 11,5 NPTF	○	○		11,5	1,64	1,10	1,50		
	16 IR 8 NPTF	16 IL 8 NPTF	○	○		8	2,42	1,30	1,80		

•Stock ○ Non Stock Item

THREADING INSERTS

External Full Profile Threading Inserts - American UN

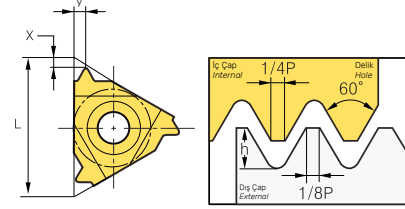
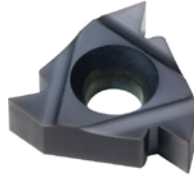

Insert Shape	Order Code		Stock Availability		Insert Size L(mm)	Pitch TPI	Size			Shim	Tool Holder
	RH	LH	RH	LH			hmin	X	Y		
	11 ER 24UN	11EL 24 UN	○	○	11	24	0.65	0.7	0.8	-	TER/L 11 S
	11ER 20UN	11 EL 20UN	○	○		20	0.78	0.8	0.9		
	11 ER 18UN	11 EL 18UN	○	○		18	0.87	0.8	1.0		
	11 ER 16UN	11 EL 16UN	○	○		16	0.97	0.9	1.1		
	11 ER 14UN	11 EL 14 UN	○	○		14	1.11	0.9	1.1		
	16 ER 36UN	16 EL 36UN	○	○		16	36	0.49	0.6		
	16 ER 28UN	16 EL 28UN	●	●	28		0.56	0.6	0.7		
	16 ER 27UN	16 EL 27UN	●	○	27		0.58	0.7	0.8		
	16 ER 24UN	16 EL 24UN	●	●	24		0.65	0.7	0.8		
	16 ER 20UN	16 EL 20UN	●	●	20		0.78	0.8	0.9		
	16 ER 18UN	16 EL 18UN	●	●	18		0.87	0.8	1.0		
	16 ER 16UN	16 EL 16UN	●	●	16		0.97	0.9	1.10		
	16 ER 14UN	16 EL 14UN	●	●	14		1.11	1.10	1.20		
	16 ER 13UN	16 EL 13UN	●	●	13		1.20	1.0	1.30		
	16 ER 12UN	16EL 12UN	●	●	12		1.30	1.10	1.40		
	16 ER 11.5UN	16 EL 11.5UN	●	○	11.5	1.30	1.10	1.40			
16 ER 11UN	16 EL 11UN	●	●	11	1.42	1.10	1.50				
16 ER 10UN	16 EL 10UN	○	●	10	1.56	1.10	1.50				
16 ER 9UN	16 EL 9UN	●	●	9	1.73	1.20	1.70				
16 ER 8UN	16 EL 8UN	●	●	8	1.95	1.20	1.60				
22 ER 7UN	22 EL 7UN	○	○	22	7	2.22	1.60	2.30	EE22	TER/L 22 S	
22 ER 6UN	22 EL 6UN	○	○		6	2.60	1.60	2.30			
22 ER 5UN	22 EL 5UN	○	○		5	3.12	1.70	2.50			

THREADING INSERTS

Internal Full Profile Threading Inserts - American UN

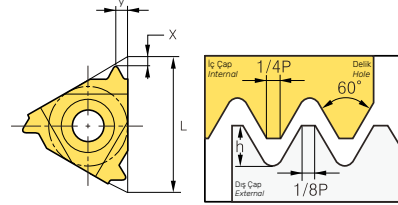
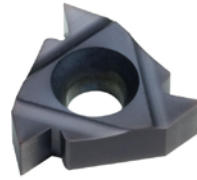

Insert Shape	Order Code		Stock Availability		Insert Size L(mm)	Pitch TPI	Size			Shim	Tool Holder
	RH	LH	RH	LH			hmin	X	Y		
	11 IR 24UN	11IL 24 UN	●	○	11	24	0.61	0.7	0.8	-	TIR/L 11 S
	11IR 20UN	11 IL 20UN	●	○		20	0.73	0.8	0.9		
	11 IR 18UN	11 IL 18UN	●	○		18	0.81	0.8	1.0		
	11 IR 16UN	11 IL 16UN	●	○		16	0.92	0.9	1.1		
	11 IR 14UN	11 IL 14 UN	●	○		14	1.05	0.9	1.1		
	11 IR 12UN	11 IL 12UN	●	○		12	1.22	0.8	1.10		
	16 IR 36UN	16 IL 36UN	○	○	16	36	0.41	0.6	0.6	E16	TIR/L 16 S/C
	16 IR 32UN	16IL 32UN	●	●		32	0.51	0.6	0.6		
	16 IR 28UN	16 IL 28UN	●	●		28	0.52	0.6	0.7		
	16 IR 27UN	16 IL 27UN	○	○		27	0.54	0.7	0.8		
	16 IR 24UN	16 IL 24UN	○	●		24	0.61	0.7	0.8		
	16 IR 20UN	16 IL 20UN	●	●		20	0.73	0.8	0.9		
	16 IR 18UN	16 IL 18UN	●	○		18	0.81	0.8	1.0		
	16 IR 16UN	16 IL 16UN	●	●		16	0.92	0.9	1.10		
	16 IR 14UN	16 IL 14UN	●	○		14	1.05	1.10	1.20		
	16 IR 13UN	16 IL 13UN	●	○		13	1.13	1.0	1.30		
	16 IR 12UN	16 IL 12UN	●	○		12	1.22	1.10	1.40		
	16 IR 11.5UN	16 IL 11.5UN	●	○		11.5	1.28	1.10	1.40		
	16 IR 11UN	16 IL 11UN	●	○		11	1.47	1.10	1.50		
	16 IR 10UN	16 IL 10UN	●	○		10	1.63	1.10	1.50		
	16 IR 9UN	16 IL 9UN	○	○	9	1.83	1.20	1.70			
16 IR 8UN	16 IL 8UN	●	○	8		1.20	1.60				
16 IR 7UN	16 IL 7UN	●	○	7							
22 IR 6UN	22 IL 6UN	○	○	22	6	2.44	1.60	2.30	E122	TIR/L 22 S	
22 IR 5UN	22 IL 5UN	○	○		5	2.93	1.70	2.50			

● Stock ○ Non Stock Item

THREADING INSERTS

External Full Profile Threading Inserts - UNJ 60°

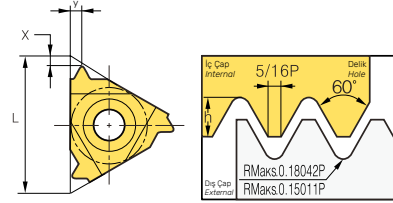
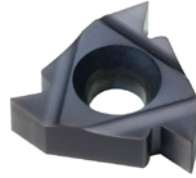

Insert Shape	Order Code		Stock Availability		Insert Size L(mm)	Pitch TPI	Size			Shim	Tool Holder
	RH	LH	RH	LH			hmin	X	Y		
	16 ER 32 UNJ	16 EL 32 UNJ	●	○	16	32	0.46	0.6	0.7	EE16	TER/L 16 S/C
	16 ER 28 UNJ	16 EL 28 UNJ	●	○		28	0.52	0.7	0.7		
	16 ER 24 UNJ	16 EL 24 UNJ	●	○		24	0.61	0.7	0.8		
	16 ER 20 UNJ	16 EL 20 UNJ	●	○		20	0.73	0.8	0.9		
	16 ER 18 UNJ	16 EL 18 UNJ	○	○		18	0.81	0.8	1.0		
	16 ER 16 UNJ	16 EL 16 UNJ	○	○		16	0.92	0.9	1.1		
	16 ER 14 UNJ	16 EL 14 UNJ	○	○		14	1.05	1.0	1.2		
	16 ER 12 UNJ	16 EL 12 UNJ	○	○		12	1.22	1.1	1.3		

Internal Full Profile Threading Inserts - UNJ 60°

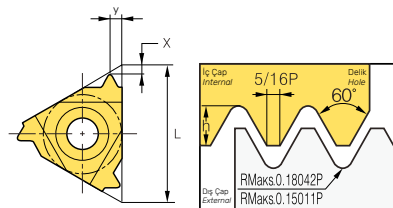
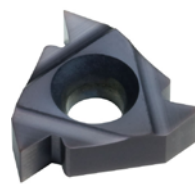

Insert Shape	Order Code		Stock Availability		Insert Size L(mm)	Pitch TPI	Size			Shim	Tool Holder
	RH	LH	RH	LH			hmin	X	Y		
	16 IR 32 UNJ	16 IL 32 UNJ	○	○	16	32	0.42	0.6	0.7	E116	TIR/L 16 S/C
	16 IR 28 UNJ	16 IL 28 UNJ	○	○		28	0.47	0.7	0.7		
	16 IR 24 UNJ	16 IL 24 UNJ	●	○		24	0.55	0.7	0.8		
	16 IR 20 UNJ	16 IL 20 UNJ	●	○		20	0.66	0.8	0.9		
	16 IR 18 UNJ	16 IL 18 UNJ	●	○		18	0.74	0.8	1.0		
	16 IR 16 UNJ	16 IL 16 UNJ	○	○		16	0.83	0.9	1.1		
	16 IR 14 UNJ	16 IL 14 UNJ	○	○		14	0.95	1.0	1.2		
	16 IR 12 UNJ	16 IL 12 UNJ	○	○		12	1.11	1.1	1.3		

● Stock ○ Non Stock Item

THREADING INSERTS

External Full Profile Threading Inserts - BSPT

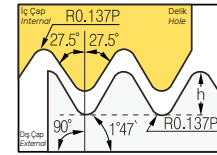
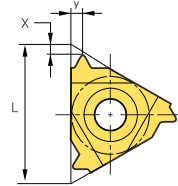
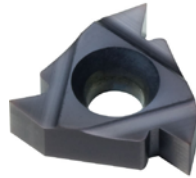

Insert Shape	Order Code		Stock Availability		Insert Size L(mm)	Pitch TPI	Size			Shim	Tool Holder
	RH	LH	RH	LH			hmin	X	Y		
	11 ER 28 BSPT	11 EL 28 BSPT	○	○	11	28	0.58	0.6	0.6	-	TER/L 11 S
	11 ER 19 BSPT	11 EL 19 BSPT	○	○		19	0.86	0.8	0.9		
	11 ER 14 BSPT	11 EL 14 BSPT	○	○		14	1.16	0.9	1.0		
	16 ER 28 BSPT	16 EL 28 BSPT	●	○	16	28	0.58	0.6	0.6	EE16	TER/L 16 S/C
	16 ER 19 BSPT	16 EL 19 BSPT	●	○		19	0.86	0.8	0.9		
	16 ER 14 BSPT	16 EL 14 BSPT	●	○		14	1.16	1.0	1.2		
	16 ER 11 BSPT	16 EL 11 BSPT	●	○		11	1.48	1.1	1.5		

Internal Full Profile Threading Inserts - BSPT

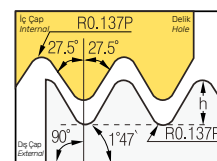
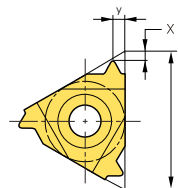
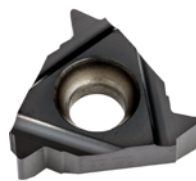

Insert Shape	Order Code		Stock Availability		Insert Size L(mm)	Pitch TPI	Size			Shim	Tool Holder
	RH	LH	RH	LH			hmin	X	Y		
	11 IR 28 BSPT	11 IL 28 BSPT	○	○	11	28	0.58	0.6	0.6	-	TIR/L 11 S
	11 IR 19 BSPT	11 IL 19 BSPT	●	○		19	0.86	0.8	0.9		
	11 IR 14 BSPT	11 IL 14 BSPT	●	○		14	1.16	0.9	1.0		
	16 IR 28 BSPT	16 IL 28 BSPT	●	○	16	28	0.58	0.6	0.6	E116	TIR/L 16 S/C
	16 IR 19 BSPT	16 IL 19 BSPT	●	○		19	0.86	0.8	0.9		
	16 IR 14 BSPT	16 IL 14 BSPT	●	○		14	1.16	1.0	1.2		
	16 IR 11 BSPT	16 IL 11 BSPT	●	○		11	1.48	1.1	1.5		

● Stock ○ Non Stock Item

THREADING INSERTS

External Full Profile Threading Inserts - Round DIN405

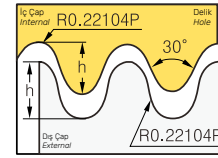
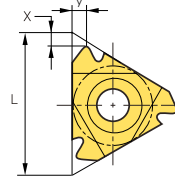
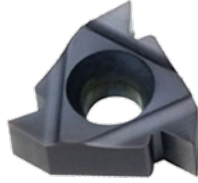

Insert Shape	Order Code		Stock Availability		Insert Size L(mm)	Pitch TPI	Size			Shim	Tool Holder
	RH	LH	RH	LH			hmin	X	Y		
	16 ER 10RD	16 EL 10RD	o	o	16	10	1.27	1.10	1.20	EE16	TER/L 16 S/C
	16 ER 8RD	16 EL 8RD	o	o		8	1.59	1.40	1.30		
	16 ER 6RD	16 EL 6RD	o	o		6	2.12	1.5	1.7		
	22 ER 6RD	22 EL 6RD	o	o	22	6	2.12	1.5	1.7	EE22	TER/L 22 S
	22 ER 4RD	22 EL 4RD	o	o		4	3.18	2.2	2.3		

Internal Full Profile Threading Inserts - Round DIN405

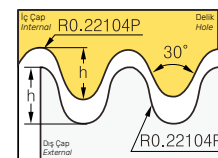
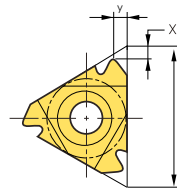
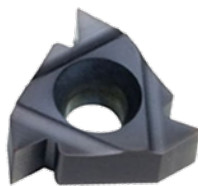

Insert Shape	Order Code		Stock Availability		Insert Size L(mm)	Pitch TPI	Size			Shim	Tool Holder
	RH	LH	RH	LH			hMIN	X	Y		
	16 IR 10RD	16 IL 10RD	o	o	16	10	1.27	1.10	1.20	EI16	TIR/L 16 S/C
	16 IR 8RD	16 IL 8RD	o	o		8	1.59	1.40	1.40		
	16 IR 6RD	16 IL 6RD	o	o		6	2.12	1.40	1.50		
	22 IR 6RD	22 IL 6RD	o	o	22	6	2.12	1.5	1.7	EI22	TIR/L 22 S
	22 IR 4RD	22 IL 4RD	o	o		4	3.18	2.2	2.3		

THREADING INSERTS

Threading Inserts with **Chipbreaker**

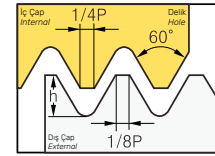
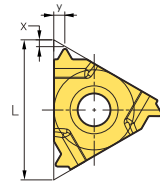

Insert Shape	Order Code		Stock Availability		Insert Size		Pitch		Size		Shim	Tool Holder
	RH	LH	RH	LH	L(mm)	mm/TPI	hmin	X	Y			
	16 ERT AG55	16 IRT AG55	●	●	16	AG55	-	1.10	1.50	EE16	TER 16 S/C TIR 16 S/C	
	16 ERT AG60	16 IRT AG60	●	●		AG60	-	1.10	1.50			
	16 ERT 1.00 ISO	16 IRT 1.00 ISO	●	●		1.00	0.58	0.70	0.70			
	16 ERT 1.25 ISO	16 IRT 1.25 ISO	○	○		1.25	0.77	0.80	0.8			
	16 ERT 1.5 ISO	16 IRT 1.5 ISO	●	●		1.50	0.92	0.80	1.00			
	16 ERT 1.75 ISO	16 IRT 1.75 ISO	○	○		1.75	1.07	1.0	1.20			
	16 ERT 2.00 ISO	16 IRT 2.00 ISO	●	●		2.00	1.23	1.00	1.30			
	16 ERT 2.5 ISO	16 IRT 2.5 ISO	●	●		2.50	1.53	1.10	1.50			
	16 ERT 3.00 ISO	16 IRT 3.00 ISO	●	●		3.00	1.84	1.20	1.50			
	16 ERT 14 W	16 IRT 14 W	●	●		14	1.16	1.00	1.20			
	16 ERT 11 W	16 IRT 11 W	●	●		11	1.48	1.10	1.50			
	16 ERT 11 BSPT	16 IRT 11 BSPT	○	○		11	1.48	1.10	1.50			
	16 ERT 14 BSPT	16 IRT 14 BSPT	○	○		14	1.33	1.0	1.20			
	16 ERT 19 BSPT	16 IRT 19 BSPT	○	○		19	-	0.8	0.9			
	16 ERT 11.5 NPT	16 IRT 11.5 NPT	○	○		11.5	1.64	1.10	1.50			

V Type Partial Profile - **60° & 55°**

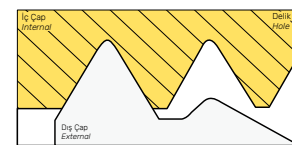
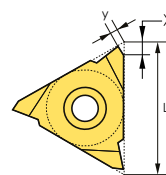
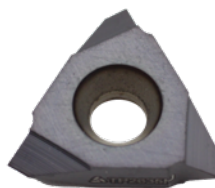

Insert Shape	Order Code		Stock Availability		Insert Size		Pitch		Size		Shim	Tool Holder
	RH	LH	RH	LH	IC	L(mm)	mm	TPI	d	X		
	16 VER A60	16 VEL A60	○	○	3/8"V	16	0.5-1.5	48-16	9.525	0.9	EE16	TVR/L..
	16 VER G60	16 VEL G60	○	○			1.75-3.0	14-8	9.525	1.7		
	16 VER AG60	16 VEL AG60	●	○			0.5-3.0	48-8	9.525	1.7		
	16 VER A55	16 VEL A55	○	○			0.5-1.5	48-16	9.525	0.9		
	16 VER G55	16 VEL G55	○	○			1.75-3.0	14-8	9.525	1.7		
	16 VER AG55	16 VEL AG55	○	○			0.5-3.0	48-8	9.525	1.7		

● Stock ○ Non Stock Item

THREADING INSERTS

Full Profile External Threading Insert - API

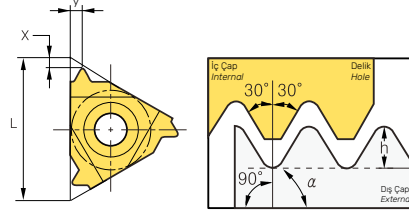
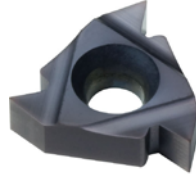

Insert Shape	Order Code		Stock Availability		Insert Size L(mm)	Pitch TPI	Size			Shim	Tool Holder
	RH	LH	RH	LH			hmin	X	Y		
	22 ER 4 API 382	22 EL 4 API 382	○	○	22	4	3,09	2,1	2,8	EE22	TER/L 22 S/C
	22 ER 4 API 383	22 EL 4 API 383	○	○		4	3,08	2,1	2,8		
	22 ER 4 API 502	22 EL 4 API 502	○	○		4	3,75	2	2,9		
	22 ER 4 API 503	22 EL 4 API 503	○	○		4	3,74	2	2,9		
	22 ER 5 API 403	22 EL 5 API 403	○	○		5	2,99	1,8	2,6		
	22 ER 6 API 551	22 EL 6 API 551	○	○	6	1,411	2,6	2			
	27 ER 4 API 382	27 EL 4 API 382	○	○	27	4	3,09	2,1	2,8	EE27	TER/L 27 S/C
	27 ER 4 API 383	27 EL 4 API 383	○	○		4	3,08	2,1	2,8		
	27 ER 4 API 502	27 EL 4 API 502	○	○		4	3,75	2,1	3,1		
	27 ER 4 API 503	27 EL 4 API 503	○	○		4	3,74	2,1	3,1		
27 ER 5 API 403	27 EL 5 API 403	○	○	5		2,99	1,9	2,7			

Full Profile Internal Threading Insert - API

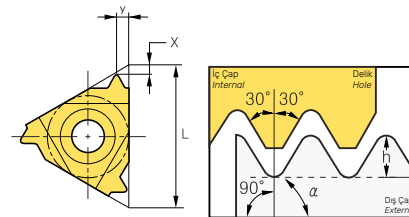
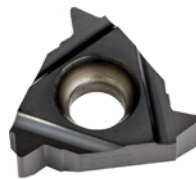

Insert Shape	Order Code		Stock Availability		Insert Size L(mm)	Pitch TPI	Size			Shim	Tool Holder
	RH	LH	RH	LH			hmin	X	Y		
	22 IR 4 API 382	22 IL 4 API 382	○	○	22	4	3,09	2,1	2,8	EI22	TIR/L 22 S/C
	22 IR 4 API 383	22 IL 4 API 383	○	○		4	3,08	2,1	2,8		
	22 IR 4 API 502	22 IL 4 API 502	○	○		4	3,75	2	2,9		
	22 IR 4 API 503	22 IL 4 API 503	○	○		4	3,74	2	2,9		
	22 IR 5 API 403	22 IL 5 API 403	○	○		5	2,99	1,8	2,6		
	22 IR 6 API 551	22 IL 6 API 551	○	○	6	1,411	2,6	2			
	27 IR 4 API 382	27 IL 4 API 382	○	○	27	4	3,09	2,1	2,8	EI27	TIR/L 27 S/C
	27 IR 4 API 383	27 IL 4 API 383	○	○		4	3,08	2,1	2,8		
	27 IR 4 API 502	27 IL 4 API 502	○	○		4	3,75	2,1	3,1		
	27 IR 4 API 503	27 IL 4 API 503	○	○		4	3,74	2,1	3,1		
27 IR 5 API 403	27 IL 5 API 403	○	○	5		2,99	1,9	2,7			

• Stock ○ Non Stock Item

THREADING INSERT HOLDERS

External Threading Tools

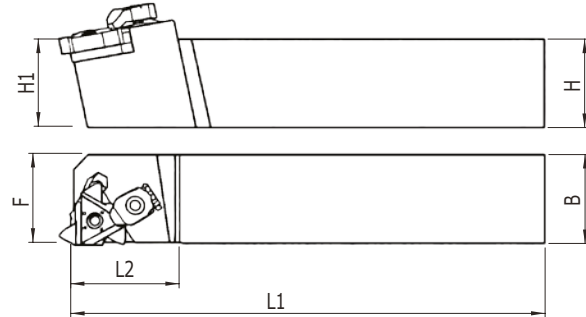

Order Code	Stock Availability		Height (H)	Width (B)	Tool Length (L1)	Insert Size	Clamping Type
	R	L					
TER/L 12-H 11S	●	●	12	12	100	11	S
TER/L 16-H 11S	●	●	16	16	100	11	S
TER/L 16-H 16S	●	●	12	12	100	16	C
TER/L 16-K 16C	●	●	16	16	125	16	C
TER/L 20-K 16C	●	●	20	20	125	16	C
TER/L 25-M 16C	●	●	25	25	150	16	C
TER/L 32-P 16C	●	●	32	32	170	16	C
TER/L 25-M 22S	●	●	25	25	150	22	S
TER/L 32-P 22S	●	●	32	32	170	22	S

(mm)

Spare Parts

Insert Size	Clamp Screw	Shim Screw	Screw Driver	External Shim	Internal Shim	Clamp
11	SM2,5X7	-	T08	-	-	-
16	SM3,5X14	SS050535M	T15	EE16	EI16	CCK0015M
22	SM4X17	SS050535M	T20	EE22	EI22	CCK0015M
27	ESN27T	ESA27T	ETA27	EE27	EI27	CCK0015M

THREADING INSERT HOLDERS

Internal Threading Tools

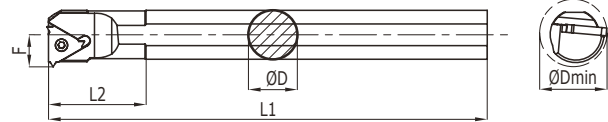

Order Code	Stock Availability		Min. Machining Diameter	Tool Diameter (D)	Tool Length (L1)	Insert Size	Clamping Type
	R	L					
TIR/L 10-K 11S	●	●	13	10	125	11	S
TIR/L 12-M 11S	●	●	15	12	150	11	S
TIR/L 16-Q 11S	●	●	20	16	180	11	S
TIR/L 16-Q 11S	●	●	13	16	180	11	S
TIR/L 17-Q 16S	●	●	16	17	180	16	S
TIR/L 20-Q 16S	●	●	16	20	180	16	S
TIR/L 20-R 16S	●	-	20	20	200	16	S
TIR/L 25-S 16C	●	●	32	25	250	16	C
TIR/L 32-T 16C	●	●	40	32	300	16	C
TIR/L 40-V 16C	●	●	50	40	400	16	C
TIR/L 25-S 22C	●	●	32	25	250	22	C
TIR/L 32-T 22C	●	●	40	32	300	22	C
TIR/L 40-V 22C	●	●	50	40	400	22	C
TIR/L 50-W22C	●	●	63	50	450	22	C
TIR/L 60-W22C	●	-	73	60	450	22	C

Spare Parts (mm)

Insert Size	Clamp Screw	Shim Screw	Screw Driver	External Shim	Internal Shim	Clamp
11	ESN11T	-	ETA11	-	-	-
16	ESN16T	ESA16T	ETA16	EI16	EE16	CCK0015M
22	ESN22T	ESA22T	ETA22	EI22	EE22	CCK0015M
27	ESN27T	ESA27T	ETA27	EI27	EE27	CCK0015M

● Stock ○ Non Stock Item

THREADING INSERT HOLDERS

V Type Threading Tools

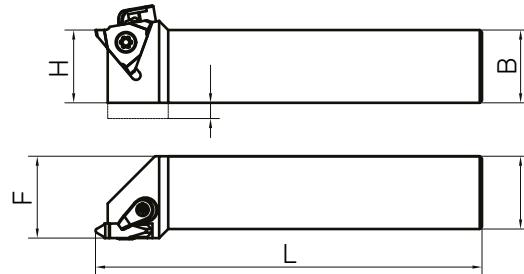

Order Code	Height (H)	Width (B)	Total Width (F)	Tool Length (L)	Insert Size
TVR/L 2020-K16	20	20	20	125	16
TVR/L 2525-M16	25	25	25	150	16
TVR/L 3232-P16	32	32	32	170	16
TVR/L 2020-K22	20	20	25	125	22
TVR/L 2525-M22	25	25	30	150	22
TVR/L 2020-K22	20	20	25	125	22
TVR/L 2525-M27	25	25	30	150	27
TVR/L 4040-R27	40	40	45	200	27

Engineered for Excellence.

#EuroloyExcellence



Italy Office



Via Leonardo Da Vinci, 4 – 20054
Milano MI ITALIA



(+39) 0282398309



info@euroloy.com

Turkey Office



Üsküdar Cad. YEDPA No:1
Ataşehir -İstanbul -TÜRKİYE



(+90) 850 933 3408



euroloytr@euroloy.com



euroloytools



Euroloy Cutting Tools